



ESA ATPROP System (RPG-HATPRO & RPG-15-90 Radiometers)

Version 2.00 (10. Oct. 2008)



System User's Manual



**by Th. Rose
Radiometer Physics GmbH,
53340 Meckenheim, Germany**

www.radiometer-physics.com





Table of Contents

Table of Contents	ii
1. Unpacking and Setting up the System.....	6
1.1 Radiometer Box.....	6
1.2 Accessories.....	7
1.3 Instrument Stand	8
1.4 Rain Sensor and GPS Clock.....	9
1.5 Dew Blower.....	9
1.5.1 Heater Module.....	10
1.6 Electrical Connections.....	11
1.7 Airflow Reduction (Thermal Stabilization System).....	13
1.8 Powering up the Radiometer.....	13
2. Theory of Operation.....	14
2.1 General Remarks.....	14
2.2 Retrieval of Atmospheric Variables.....	16
2.3 ATPROP Operating Modes.....	17
2.4. Vertical Resolution.....	18
2.5 References	18
3. Instrument Hardware.....	20
3.1 Overview	20
3.2 Receivers.....	23
3.3 Detailed Description of Receiver Components.....	27
3.3.1 Antenna Performance.....	27
3.3.2 Noise Diodes	28
3.3.3 RF-Amplifiers	29
3.3.4 Bandpass Filters	29
3.3.5 Detector, Video Amplifier, ADC	29
3.4 Additional Sensors	29
3.5 Other Radiometer Details.....	30
3.6 Instrument Specifications.....	31
4. Calibrations	34
4.1 Absolute Calibration	34
4.1.1 The Internal Ambient Temperature Calibration Target	34
4.1.2 External Liquid Nitrogen Cooled Calibration Target	35
4.1.2.1 Assembly of the LN Cooled Target for HATPRO Radiometer	36
4.1.3 General Remarks on Absolute Calibrations.....	40
4.1.3.1 System Nonlinearity Correction.....	40
4.1.3.2 Avoiding Errors from Variable System Noise Temperature.....	41
4.2 Noise Injection Calibration	42
4.3 Gain Calibration (Relative Calibration).....	43
4.4 Sky Tipping (Tip Curve).....	43
4.5 Calibration Equations	44
5. Software Description.....	46
5.1 Installation of Host Software.....	46
5.1.1 Hardware Requirements for Host PC.....	46
5.1.2 Directory Tree	46
5.2 Getting Started.....	48
5.3 Radiometer Status Information	50



5.4 Data Storage Host Configuration	52
5.5 Exchanging Data Files	54
5.6 Inspecting Absolute Calibration History	55
5.7 Inspecting Automatic Calibration Results	56
5.8 Absolute Calibration	58
5.9 Defining Measurements	60
5.9.1 Sky Tipping	60
5.9.2 Defining Automatic Standard Calibrations	62
5.9.3 Products + Integration	62
5.9.4.1 Scanning	65
5.9.4.2 Satellite Tracking	66
5.9.5 Timing +	67
5.9.6 MDF + MBF Storage	69
5.10 Sending a MBF to the Radiometer	70
5.11 Commanding the Radiometer Processes	71
5.12 Monitoring Data	71
5.13 Concatenate Data Files	76
5.14 Cutting Connection	76
5.15 Data Post Processing	77
5.16 Data Display Menus	78
5.16.1 Data filters	81
5.16.2 Import Radiosonde Files	81
5.16.3 Generate Composite Temperature Profiles	83
5.16.4 Generate Cloud Base Height Charts	85
5.16.5 Housekeeping Data Display	85
5.16.6 Full Sky Scanning Displays	86
5.17 Manual Radiometer Control	90
5.17.1 Elevation / Azimuth	91
5.17.2 Channel Voltages	91
5.17.3 Sensor Calibration	93
5.17.4 Radiometer System	93
5.18 Transform Data Files to ASCII and netCDF Format	94
5.19 Auto Viewer	95
5.20 Current Sample Files	96
5.21 Master / Slave Operation	98
6. Retrievals	102
6.1 Retrieval Algorithms	102
6.1.1 General remarks	102
6.1.2 Data source and applicability	102
6.1.3 Data quality processing and reformatting	103
6.1.4 Cloud processing	103
6.1.5 Angle and frequency selection	104
6.1.6 Radiative Transfer calculations	104
6.1.7 Retrieval grid and type of regression	104
6.1.8 Algorithm performance	104
6.1.9 File Format	105
6.2 Retrieval File Structure	106
6.2.1 Linear Regressions	107
6.2.2 Quadratic Regressions	107
6.2.3 Neural Networks	108
6.3 Retrieval File Templates	108



7. Instrument Maintenance and Recommendations	109
7.1 Cleaning	109
7.2 Calibrations	109
7.3 Maintenance Schedule.....	110
7.4 Resetting of Radiometer Embedded PC.....	110
7.5 Restarting Host.....	111
7.6 Instrument Viewing Range.....	112
7.7 Upgrading System Software.....	113
7.8 Changing the Microwave Window	114
7.9 Replacing the External Surface Sensors.....	116
8. Mounting of Accessories and Optional Hardware	117
8.1 Infrared Radiometer	117
8.2 Fiber Optics Data Cable (Upgrade Version).....	118
9. Trouble Shooting.....	124
Appendix A (File Formats)	127
A1: LWP-Files (*.LWP), Liquid Water Path.....	127
A2: IWV-Files (*.IWV), Integrated Water Vapour	127
A3: ATN-Files (*.ATN), Atmospheric Attenuation	128
A4: BRT-Files (*.BRT), Brightness Temperature	128
A5: MET-Files (*.MET), Meteorological Sensors	129
A6: OLC-Files (*.OLC), Oxygen Line Chart	129
A7: TPC-Files (*.TPC), Temperature Profile Chart (Full Trop.)	130
A8: TPB-Files (*.TPB), Temperature Profile Chart (Boundary Layer)	130
A9: WVL-Files (*.WVL), Water Vapour Line Chart.....	130
A10(1): HPC-Files (*.HPC), Humidity Profile Chart (without RH)	131
A10(2): HPC-Files (*.HPC), Humidity Profile Chart (including RH)	131
A11: LPR-Files (*.LPR), Liquid Water Profile Chart	132
A12: IRT-Files (*.IRT), Infrared Radiometer Temperatures.....	132
A13: BLB-Files (*.BLB), Boundary Layer BT Profiles	133
A14: STA-Files (*.STA), Stability Indices.....	134
A15: Structure of Calibration Log-File (CAL.LOG).....	134
A16: CBH-Files (*.CBH), Cloud Base Height	137
A17: VLT-Files (*.VLT), Channel Voltage File	137
A18: HKD-Files (*.HKD), Housekeeping Data File	138
A19: ABSCAL.HIS, Absolute Calibration History File.....	140
A20: LV0-Files (*.LV0), Level Zero (Detector Voltages) Data Files.....	142
Appendix B (ASCII File Formats).....	146
B1 Housekeeping ASCII file format	149
Appendix C (Examples)	151
C1. Introduction	151
C2. Temperature Profiling.....	151
C2.1 Zenith Observation Mode.....	151
C2.2 Boundary Layer Scanning Mode.....	152
C2.3 Comparison Between the Two Modes.....	153
C2.3.1 Comparison with Radiosonde Data	155
C2.4 Development and decay of an inversion.....	157
C2.5 Comparison with Meteorological Tower Observations.....	159
C2.6 Extreme Inversions	163
C3. Humidity Profiling.....	165
C3.1 Examples of Absolute and Relative Humidity Profiles.....	166
C3.1.1 RPG-HATPRO Measurements.....	166



C3.1.2 RPG-LHATPRO Humidity Profiling	174
C4. LWP and IWV Measurements	178
C5. Stability Indices	180
C6. Scanning	181
C7. Acknowledgement	185
Appendix D (COMS.ADR File Adaptation).....	186
Appendix E (Physical Radiometer Dimensions).....	189
Appendix F (Interconnections).....	190
Appendix G (Inventory List).....	190

1. Unpacking and Setting up the System

The following components are delivered in addition to the radiometers (packing list):

- 2 Host computers with installed operating software (industrial type)
- Instrument azimuth table with adjustable feet
- 3 external absolute calibration targets (2 cold targets, one hot target), precision thermometer for hot target
- Azimuth driver supply unit
- Connector protectors
- Power cables, data interface cables (fiber optics), azimuth supply cable, 50 m long
- 2 blower systems + 2 heater modules
- Infrared radiometer for the 9-11 μm range

1.1 Radiometer Box

The ATPROP system is shipped in three wooden boxes. Two of these contain the radiometers and the third stores all accessories needed to operate and calibrate the instrument. The radiometer box is fastened to the container by two straps as indicated in Fig.1.1. The dew blower is also included in the radiometer transportation box but all other components like rain sensor and GPS-clock are dismounted for transportation and stored in the accessory box.



Fig.1.1: Radiometer unit packed up in its transport container

1.2 Accessories

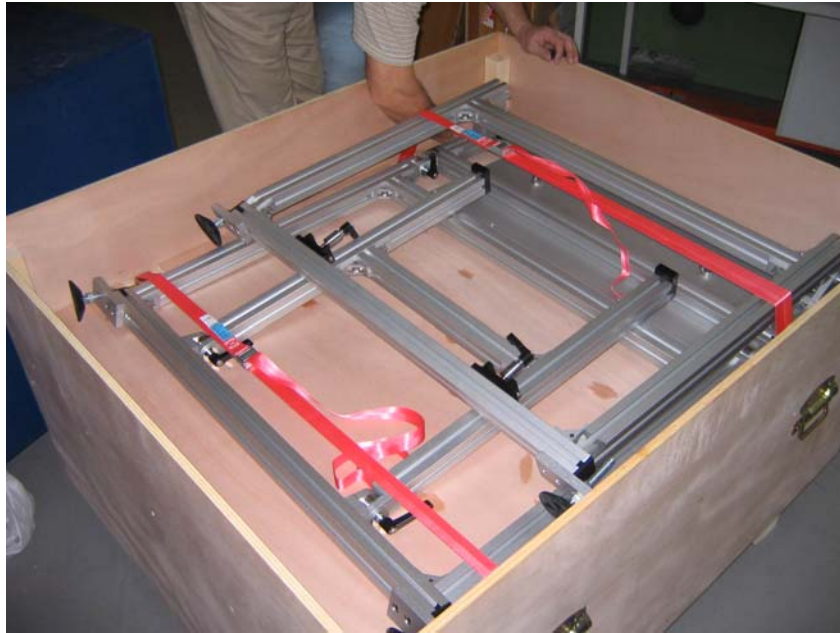

Fig.1.2: Top layer of accessory box with radiometer stand.



Fig.1.3: Removing intermediate board to get access to the other accessories.

The accessory box has two layers to store additional radiometer parts. The bottom layer (Fig.1.3) comprises the dew blower system, LN cooled calibration target, laptop computer, cables, GPS clock and rain sensor. The top layer stores the radiometer stand (Fig.1.2).

When the stand is removed from the accessory box an intermediate board becomes visible. By removing the wing nuts at the board edges and taking it out, the frame of the bottom layer appears. It is recommended to keep the accessory box for future transportation.

1.3 Instrument Stand

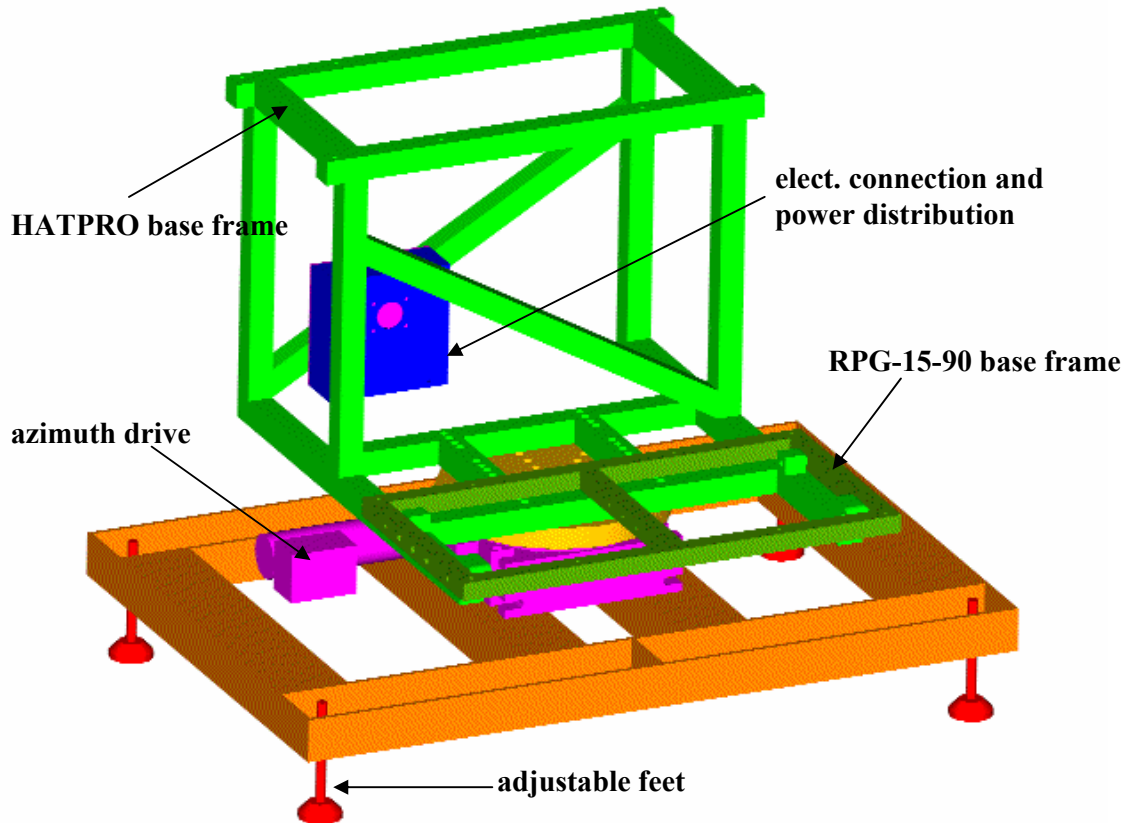
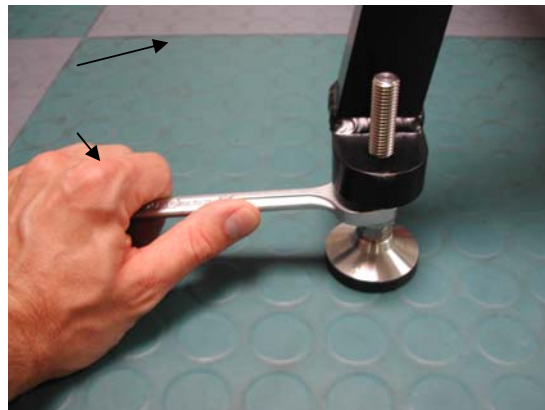

Fig.1.4: Instrument stand and azimuth table.

The base frames have a total of 8 holes each to attach the instrument using M8 screws. The radiometer housings have six M8 threads on their bottom plate that align with the 8 corresponding holes in the stand's mounting plate.

It is important to balance the radiometer accurately so that the radiometer bottom plate (reference plane) is horizontally aligned. Otherwise the reading of the elevation axis during measurements is not equivalent to the real observation elevation angle. The inclination angles of the elevation axis and the direction normal to it are adjusted by inspecting the lever meters attached to the stand's table and changing the stand's 4 individual feet heights (M19 wrench required).



After positioning the radiometer on the stand, the threads in the bottom plate have to be aligned with the screw holes of the stand's top plate. Eight M8 screws are then used to make a tight mechanical connection.

1.4 Rain Sensor and GPS Clock

After the radiometers have been mounted on the azimuth positioner frame, the rain sensors and GPS clock can be installed. Each unit has a single waterproof connector for power supply and data transfer. The rain sensor is fixed to the housing by two M4 screws and the GPS clock is attached with a clamped rod (see Fig.1.7).

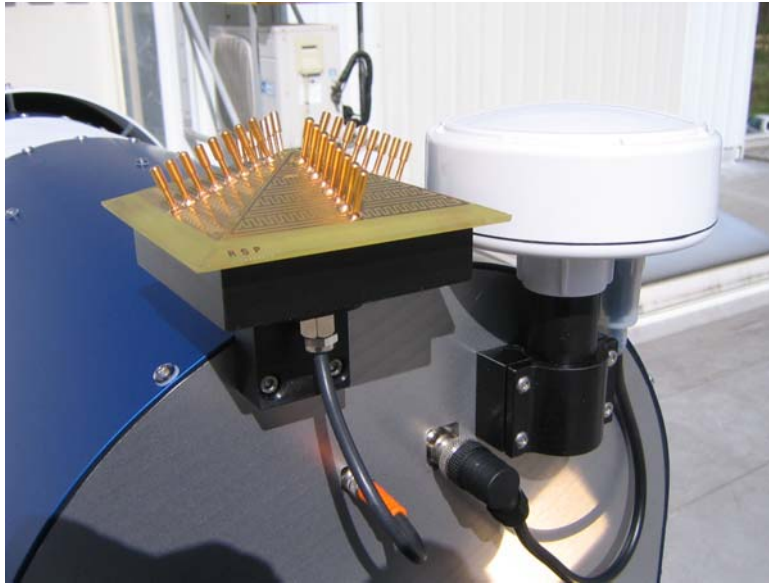

Fig.1.7: Rain sensor and GPS clock attached to the radiometer housing.

1.5 Dew Blower

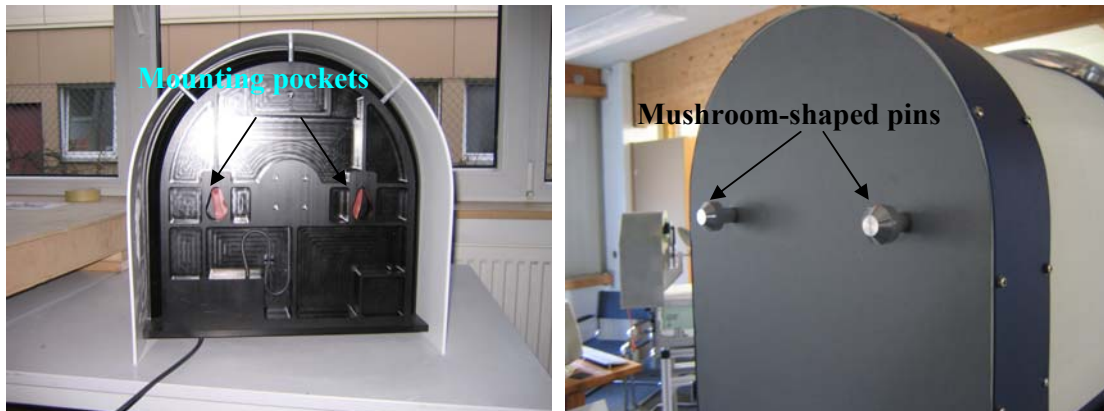

Fig.1.8: Dew blower mounting.

The dew blower system is attached to the radiometer by aligning its mounting pockets with the associated mushroom-shaped pins located at the instrument housing. The blower must be slightly pressed against the radiometer and then slid down to the rest position. In order to remove the dew blower from the radiometer lift the blower upwards (about 3 cm) and pull it

away from the radiometer housing. Do not forget to connect the control cable to the radiometer (see Fig.1.9). For UPS operation of the radiometer power supply it is possible to bypass the dew blower with an external power supply. This supply can be connected to the dew blower via a separate input and a power source switch selects the external supply or internal radiometer supply (optional).

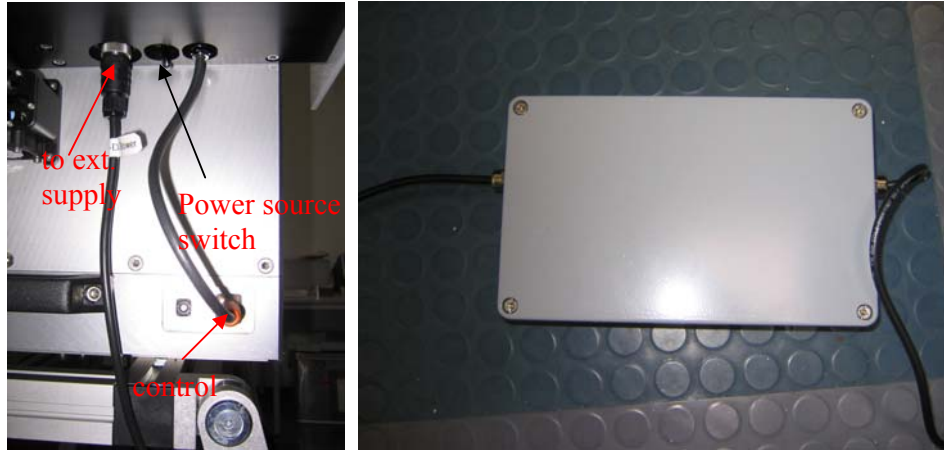

Fig.1.9: Electrical dew blower connections and external power supply.

1.5.1 Heater Module

The dew blower (even when it is extremely powerful) alone is not sufficient to keep the microwave window free of liquid water under all environmental conditions. E.g. surface fog consists of very small droplets comparable to the size of cloud droplets (diameter 10-30 μm). Hydrophobic coatings of microwave windows do not work for these small droplets and the relative humidity during fog is about 100% so that the air cannot store and remove any more humidity. Thus the blower's air flow is not efficient enough to prevent the formation of a wet window contamination. In this situation only a heated air flow can help.

RPG offers a heater module for the blower that, when turned on, increases the air temperature by 6°C-10°C above the environmental temperature, even in the blower's full power mode. The heater's power is switched on together with the blower's high speed mode. Thus it is controlled by the combination of rain sensor and user defined humidity threshold. Two heater models are available (1300 Watts and 1800 Watts heating power), both offered for 110 V AC and 220 V AC.

The heater module has a separate power cable to be independent from the radiometer supply which might be powered by a UPS. The blower's cable that is usually connected to the radiometer housing, plugs into the heater module and the heater module control cable plugs into the radiometer connector. This way, the heater module is also controlled by the radiometer as the blower itself.

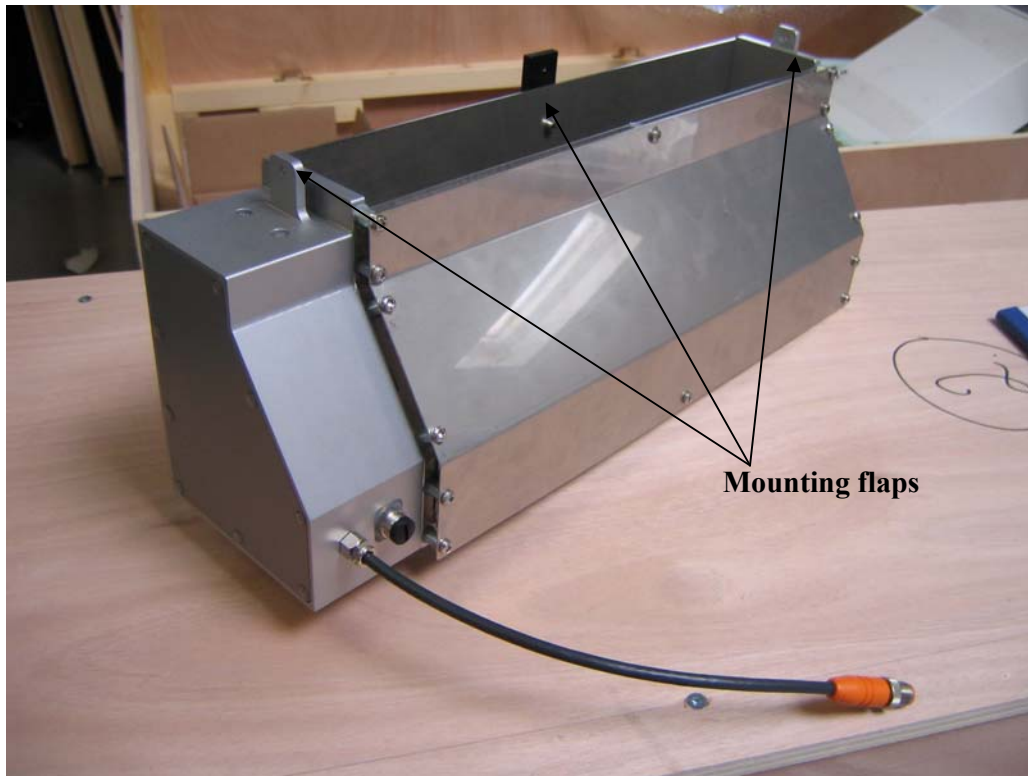

Dew Blower heater module. The unit is mounted underneath the dew blower at its air inlet.



Heater mounted to the blower unit. The blower supply cord is connected to the heater instead of the radiometer and the heater is directly plugged into the radiometer box. The heater is powered via an AC power cable and consumes 2 kW of power. Voltage: 220 V/AC (for US or Japanese customers we provide a transformer 110 V → 220 V).

1.6 Electrical Connections

There are only two external connections to the radiometer: The main power cable (90-240 V AC, 50 to 60 Hz) and the serial interface (RS-232) cable to the host computer (e.g. laptop), see fig.1.10. The interface cable has an 8 pin connector to be plugged into the instrument and a 9 pin Sub-D connector to the RS232 interface of the host computer. Both connectors are located on side A of the instrument housing (see Fig.1.10). The optional infrared radiometer is attached to this side where four mounting threads and interface + power connectors are provided for plug and play installation.

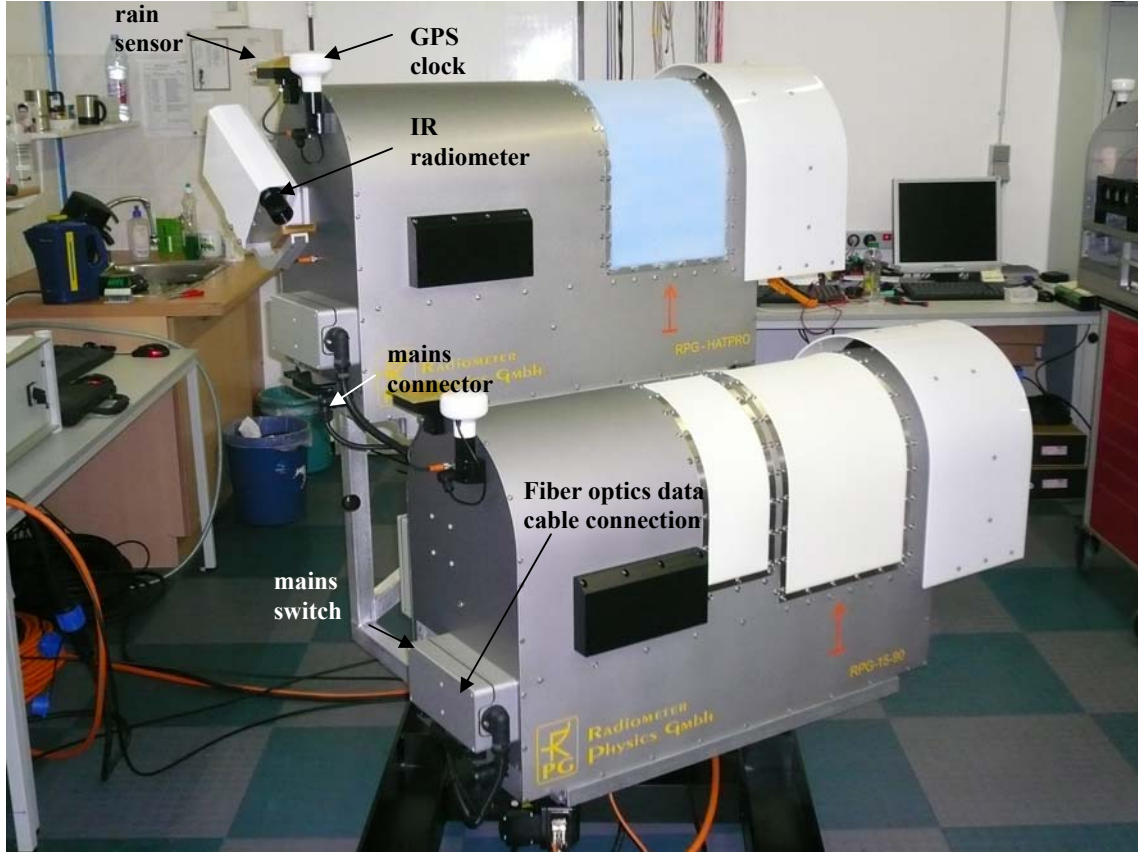

Fig.1.10: Instrument connectors and sensors (side A).

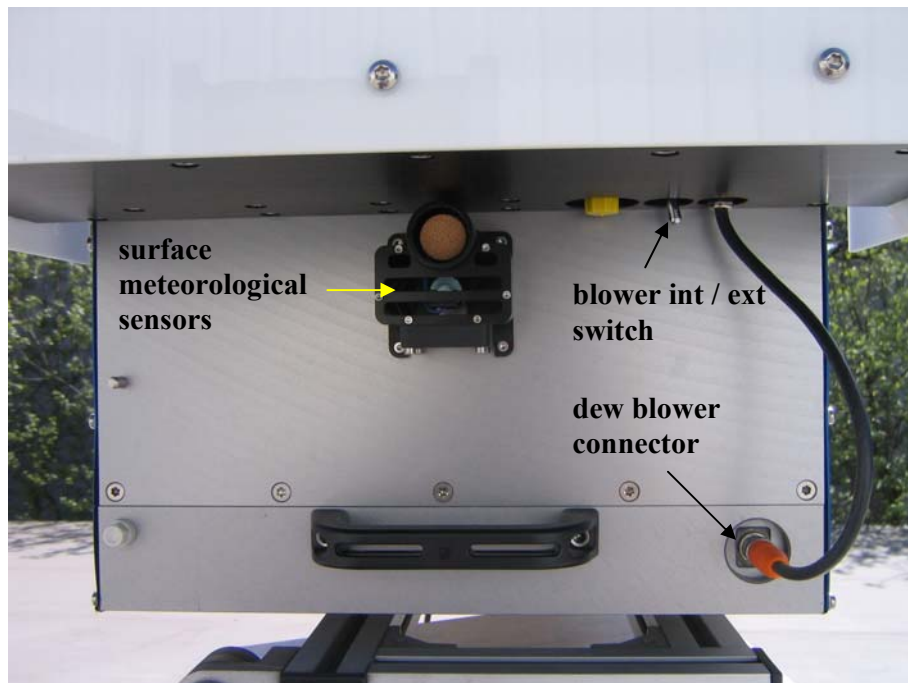

Fig.1.11: Instrument connectors and sensors on side B

Each radiometer is controlled by its own built-in PC (embedded PC) which handles all internal activities like data interfacing with the external host PC, data acquisition of all

housekeeping channels and detector signals, controlling of elevation stepper, backup storage of measurement data, automatic and absolute calibration procedures, retrieval calculations etc.

1.7 Airflow Reduction (Thermal Stabilization System)

The radiometer's receivers are thermally stabilized to an accuracy of ± 0.05 K. Due to this extra ordinary stability the receivers can run without gain calibration for almost 10 minutes and still maintain an absolute radiometric accuracy of ± 0.5 K. This is achieved by a dual stage control system consisting of a stabilized main cooler (accuracy: ± 0.1 K) followed by a Peltier stage for the receivers.

The thermal stabilisation was tested in an environmental chamber in the operating range of -30°C to $+45^{\circ}\text{C}$. It was found that ± 0.03 K accuracy for the receiver boards can be maintained when an airflow reduction inlay is installed during winter time ($T < -10^{\circ}\text{C}$) which should be removed in summer (see Fig.1.12A). This inlay is included in the accessories and is used preferably on the air inlet side (see Fig. 1.12).



Fig.1.12: Installation of airflow reduction inlet for winter operation.

The inlay is intended to be used below -10°C but also works up to $+10^{\circ}\text{C}$.

1.8 Powering up the Radiometer

After all mechanical and electrical connections have been established the radiometers can be turned on (Fig.1.10: Power ON/OFF switch). The embedded PCs take about 60 seconds to boot and start the radiometer software. This will then perform several initialization procedures like resetting the stepper motors to their index position. Wait at least 30 minutes for warm-up at operating temperatures $>10^{\circ}\text{C}$ and 45 minutes warm-up time at lower environmental temperatures. The stabilization process can be inspected in the DIAGNOSTICS menu on the host computer.

During warming up the system actively heats the receivers with a total power consumption of 350 Watts. Once the receivers are thermally stabilized, the power consumption drops down to less than 150 Watts.



The dew blower is operated at two speeds. The low power mode is active under dry conditions (no rain, rel. humidity less than software defined threshold) and consumes about 70 Watts. In high power mode (rain or high humidity level) the blower consumption is 130 Watts.

2. Theory of Operation

2.1 General Remarks

Atmospheric profiles of temperature, humidity, wind direction and speed are typically measured by radiosondes launched from facilities maintained by the national weather services. Their operation is expensive and requires extended logistics, and hence results in a poor spatial (several hundred kilometers at best) and temporal (about twice a day) coverage.

Remote sensing of temperature and humidity profiles from satellites yields better spatial coverage especially over oceans and sparsely populated land areas, however, the obtained horizontal and temporal resolution is coarse. Due to their viewing geometry, the vertical resolution is good in the upper troposphere but deteriorates towards the surface. Because clouds strongly absorb in the infrared spectral region several satellite instruments (e.g. the Advanced Microwave Sounding Unit AMSU and the Special Sensor Microwave/Temperature SSM/T sounder) operate in the microwave region where clouds are semi-transparent. Profiling is achieved by measuring the atmospheric emission along the wings of pressure broadened rotational lines. The 60 GHz oxygen absorption complex is typically used for temperature profiling while the 183 GHz water vapor line is used for the humidity profile. Because the atmospheric opacity is high for both bands, the problem of the unknown surface emission is eliminated.

The usefulness of ground-based microwave radiometry for the retrieval of temperature and humidity profiles has been proven for quite some time [e.g. Westwater et al, 1965; Askne et al, 1986]. Due to the low maintenance requirements of microwave radiometers, continuous atmospheric profiles can be measured which have the highest vertical resolution close to the ground in the planetary boundary layer. This feature is extremely important for the evaluation of (and incorporation into) high resolution numerical weather forecast models of the future. Due to technical improvements and the intensifying search for alternatives to radiosondes, multi-channel microwave radiometers for the operational profiling of tropospheric temperature and humidity have been developed in the last few years [Del Frate et al, 1998; Solheim et al, 1998].

An additional advantage of ground-based microwave radiometers is their sensitivity to cloud liquid water. Over the land, passive microwave remote sensing is by far the most accurate method to measure the vertically integrated liquid water content (liquid water path, LWP) other than sporadic and expensive in-situ measurements from research aircraft. More than two decades ago [Westwater, 1978] two channel radiometers were shown to achieve high accuracy in the retrieved LWP and the integrated water vapour content (IWV).

In the last few years, further improvements to the LWP retrieval have been made by the inclusion of additional microwave channels [Bosisio and Mallet, 1998] and the combination of microwave radiometer measurements with other ground-based instrumentation [Han and Westwater, 1995]. The potential of deriving cloud liquid water profiles, rather than just the column amount, using multi-channel measurements has been suggested by Solheim et al. [1998].

Satellite based remote sensing of LWP over the oceans is a well established method [Grody, 1993], however, the inhomogeneous distribution of clouds within the satellites field of view (typical several kilometers), can lead to substantial errors (von Bremen, private communications). This effect has mostly been neglected for ground-based radiometers whose

viewing geometry is often assumed to behave as a pencil beam although the spatial and temporal variability of clouds is high even on scales below the resolution of most radiometers [Rogers and Yau, 1989]. With a typical wavelength of about 1 cm, practical considerations about the antenna aperture size (about 20 cm) lead to half-power beamwidths from 2° to 4° for conventional radiometers. These beamwidths correspond to footprints of up to several 100 m at cloud base heights.

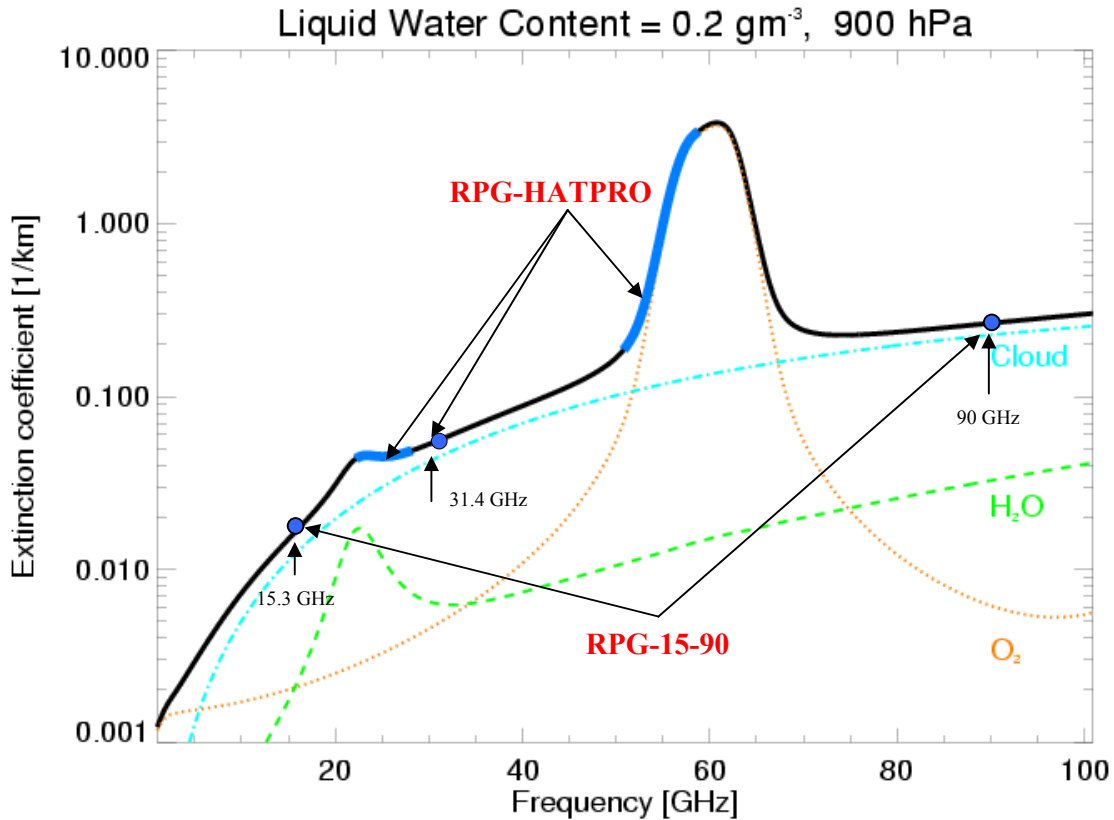

Fig.2.1: Atmospheric emission of liquid water, water vapour and oxygen. The frequency bands marked in blue are utilized by RPG's radiometers to derive LWP, IWV, Humidity and Temperature Profiles (full troposphere and boundary layer).

Atmospheric water vapour profile information is derived from frequency channels covering 6 GHz of the high frequency wing of the pressure broadened, relatively weak water vapour line (22-28 GHz). With a pressure broadening coefficient of about 3 MHz/hPa information between approx. 300 and 1000 hPa can be resolved with the spectral measurements. In the center of the oxygen absorption complex the atmosphere is optically thick and the measured radiation originates from regions close to the radiometer. For frequencies further away from the line center the atmosphere gets more transparent and the channels receive radiation which originates from regions more distant to the radiometer (see Fig.2.1). Due to the known mixing ratio and the temperature dependence of the absorption coefficient of oxygen, information about the vertical temperature distribution is contained in the channels spanning the 8 GHz of the low frequency side.

For a ground based radiometer pointing to zenith, well defined weighting function peaks for each frequency are observed (see Fig.2.2b). If the elevation angle is lowered, (and hence the atmospheric path is increased), the peaks shift to lower altitudes. This demonstrates the radiometer's superiority in the retrieval of the planetary boundary layer temperature.

The cloud liquid water contribution to the microwave signal increases roughly with the frequency squared. It depends on temperature and is proportional to the third power of the particle radius. Therefore measurements at two channels, one influenced mainly by the water vapor line and one in the 30 GHz window region lead to good estimates of LWP and IWV [for example Westwater, 1978].

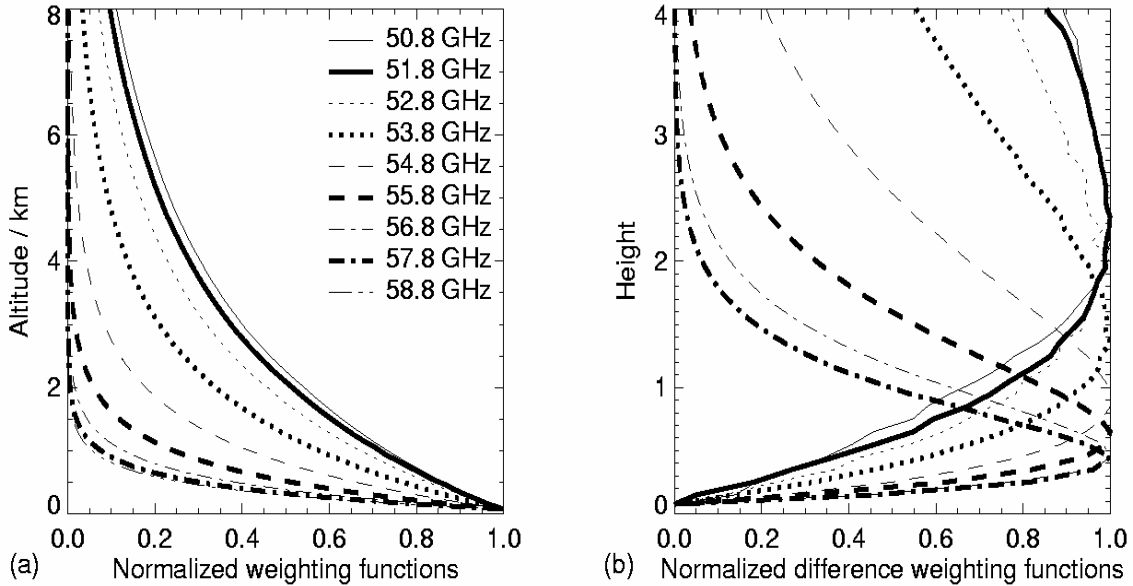

Fig.2.2: Weighting functions for the oxygen line complex channels.

2.2 Retrieval of Atmospheric Variables

Artificial neural networks (ANN) are increasingly used for the retrieval of geophysical parameters from measured brightness temperatures (for example Del Frate et al, 1999; Solheim et al, 1999; Churnside et al; 1994). They can easily adapt to nonlinear problems such as the radiative transfer in the cloudy atmosphere. Additionally, input parameters of a diverse nature can be easily incorporated into neural networks.

We use a standard feed forward neural network [Jung et al., 1998] where the cost function is minimized employing the Davidon-Fletcher-Powell algorithm. The architecture of the ANN used for the retrieval includes an input layer consisting of simulated brightness temperatures for the PRG-HATPRO frequencies, a hidden layer with a certain number of neurons (nodes) and an output layer with the atmospheric variable of interest (LWP, IWV, temperature, or humidity profile). To derive the weights between the nodes of the different layers we generated a data set comprising about 15,000 possible realizations of the atmospheric state, which was divided into three sub sets; the first for training, the second for generalization (finding the optimum number of iterations to avoid over fitting), and the third for evaluating the retrieval RMS. For each output parameter the optimal network configuration – number of nodes in the hidden layer, number of iterations and initial weight – was derived and the retrieval performance was evaluated using the third data subset. Generally, it can be stated that all algorithms developed show no systematic errors.

The data set is based on atmospheric profiles of temperature, pressure and humidity measured by radiosondes. In order to analyze profiles of cloud liquid water content (LWC) from the radio soundings, we chose a relative humidity threshold of 95 % as a threshold for the

presence of clouds and calculated a modified adiabatic LWC-profile as proposed by Karstens et al. [1994]. Radiation transfer calculations were performed for each radio sounding using MWMOD [Simmer, 1994, Fuhrhop]. A random noise of 1 K was added to the resulting brightness temperatures to simulate radiometric noise. Realistic noise was also added to the other potential input parameters like the standard meteorological measurements (ground level temperature (Tgr), pressure (pgr), relative humidity (qgr)) and the cloud base temperature (Tcl) as derived by an infrared radiometer (if provided).

It should be noted that a limitation to ANN algorithm, as to all statistical algorithms, is that they can only be applied to the range of atmospheric conditions, which is included in this data set. When extrapolations beyond the states included in the algorithm development are made, ANNs can behave in an uncontrolled way, while simple linear regressions will still give a reasonable, although erroneous, result. Quadratic regressions offer the robustness of a linear regression retrieval with the advantage to model nonlinearities much better than linear regressions. In many cases where unusual atmospheric conditions are likely the quadratic regression is the best choice.

2.3 ATPROP Operating Modes

The RPG-HATPRO (and related radiometers) supports two temperature profiling modes: Full troposphere profiling (frequency scan across the oxygen line) and boundary layer scanning (elevation scan @ 54.9 and 58 GHz). 22.4 GHz WVH humidity profiling is only available for the full troposphere mode (HATPRO) due to the lack of opaque channels on the water vapour line at 22.4 GHz.

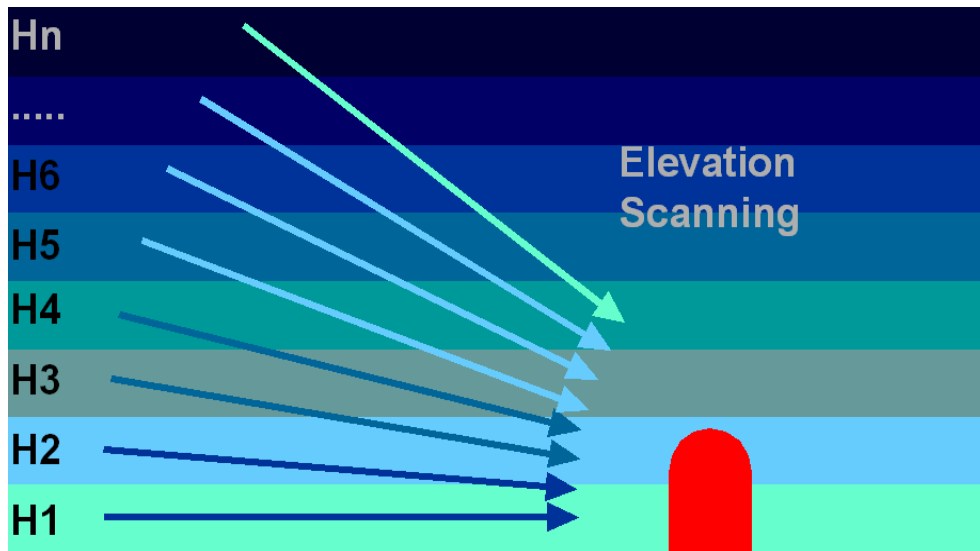

Fig.2.3: Elevation scanning technique used for boundary layer temperature profiling.

For boundary layer temperature profiling the radiometer beam is scanned in elevation between 5° and zenith (Fig.2.3). At the frequencies in use (54.9 GHz and 58 GHz) the atmosphere is optically thick. The frequencies weighting functions peak at 500 m (58 GHz) and 1000 m (54.9 GHz), see Fig.2.2. The receiver stability and accuracy has to be optimized due to the small brightness temperature variations that must be resolved in the elevation scanning method. In the RPG-HATPRO models the receiver's physical temperature is stabilized to better than 30 mK over the whole operating temperature range (-30°C to 40°C) to



guarantee a high gain stability during measurements (>200 sec). The receiver noise temperature is minimized to be better than 700 K which reduces the overall noise level.

2.4. Vertical Resolution

From the weighting functions corresponding to the various water vapour line and oxygen line profiling frequencies, the vertical resolution of the retrieval outputs can be derived:

- Tropospheric temperature profiles (0-10000 m): 200 m (<5000 m altitude), 400 m above, profile accuracy: +/- 0.6 K RMS (0-2000 m), +/- 1.0 K RMS (>2000 m)
- Boundary layer temperature profiles (0-1200 m), 50 m vertical resolution, profile accuracy: +/- 0.7 K RMS
- Tropospheric humidity profiles (0-5000 m), 200 m vertical resolution (0-2000 m), 400 m (2000 m – 5000 m), profile accuracy: +/- 0.4 g/m³ RMS

2.5 References

- Bosisio, A. V., and C. Mallet, Influence of cloud temperature on brightness temperature and consequences for water retrieval, *Radio Science*, 33, 929-939, 1998.
- Chernykh, I. V. and R. E. Eskridge 1996, determination of cloud amount and level from radiosonde soundings, *Journal of Applied Meteorology*, 35, 1362-1369, 1996.
- Churnside, J. H., T. A. Stermitz, and J. A. Schroeder, Temperature profiling with neural network inversion of microwave radiometer data, *J. Atmos. Oceanic Technol.*, 11, 105-109, 1994.
- Crewell, S., U. Löhnert, and C. Simmer, Remote sensing of cloud liquid water profiles using microwave radiometry, *Proc. of Remote Sensing of Clouds: Retrieval and Validation*, October 21-22, 1999, Delft, Netherlands, 6 pages, 1999.
- Crewell, S., G. Haase, U. Löhnert, H. Mebold, and C. Simmer, A ground based multi-sensor system for the remote sensing of clouds. *Phys. Chem. Earth (B)*, 24, 207-211, 1999.
- Czekala, H., A. Thiele, A. Hornborstel, A. Schroth, and C. Simmer, Polarized microwave radiation from nonspherical cloud and precipitation particles, *Proc. of Remote Sensing of Clouds: Retrieval and Validation*, October 21-22, 1999, Delft, Netherlands, 6 pages, 1999.
- Czekala, H., and C. Simmer, Microwave radiative transfer with non-spherical precipitating hydrometeors. *Journal of Quantitative Spectroscopy and Radiative Transfer*, 60, 365-374., 1999.
- Del Frate, and F., G. Schiavon, A combined natural orthogonal functions/neural network technique for the radiometric estimation of atmospheric profiles, *Radio Science*, 33, 405-410, 1998.
- Grody, N. C., Remote sensing of the atmosphere from satellites using microwave radiometry, 259-334, in *Atmospheric remote sensing by microwave radiometry*, Ed. M. A. Janssen, John Wiley & Sons, 1993.
- Han, Y., and E. Westwater, Remote sensing of tropospheric water vapor and cloud liquid water by integrated ground-based sensors, *J. Atmos. Oceanic Technol.*, 12, 1050-1059, 1995.
- Hogg, D. C., F. O. Guiraud, J. B. Snider, M. T. Decker, and E. R. Westwater, A steerable dual-channel microwave radiometer for measurement of water vapor and liquid in the troposphere, *J. Climate Appl. Meteor.*, 22, 789-806, 1983.
- Jung, T., E. Ruprecht, and F. Wagner, Determination of cloud liquid water path over the oceans from SSM/I data using neural networks, *Journal of Applied Meteorology*, 37, 832-844, 1997.



- Th. Rose, R. Zimmermann, and R. Zimmermann, A precision autocalibrating 7 channel radiometer for environmental research applications, *Japanese Journal for Remote Sensing*, 1999 (in press).
- Karstens, U., C. Simmer, and E. Ruprecht, Remote sensing of cloud liquid water, *Meteorol. Atmos. Phys.*, 54, 157-171, 1994.
- Li, L., J. Vivekanandan, C. H. Chan, and L. Tsang, Microwave radiometric technique to retrieve vapor, liquid and ice, Part I – development of a neural network-based inversion method, *IEEE Transactions on Geoscience and Remote Sensing*, 35, 224-236, 1997.
- Löhnert, U., S. Crewell, and C. Simmer, Combining cloud radar, passive microwave radiometer and a cloud model to obtain cloud liquid water, *Proc. of Remote Sensing of Clouds: Retrieval and Validation*, October 21.-22, 1999, Delft, Netherlands, 6 pages, 1999.
- Mätzler, C., Ground-based observation of atmospheric radiation at five frequencies between 4.9 and 94 GHz, *Radio Science* 27, 403-415, 1992.
- Peter, R., and N. Kämpfer, Radiometric determination of water vapor and liquid water and 1st validation with other techniques, *Journal of Geophysical Research*, 97, 18,173-18,183, 1992.
- Rogers, R. R. and M. K. Yau, A short course in cloud physics, Third Edition, International Series in Natural Philosophy, Vol. 113, 290 pages, 1989.
- Simmer, C., Satellitenfernerkundung hydrologischer Parameter der Atmosphäre mit Mikrowellen, Kovac Verlag, 313 pp., 1994.
- Solheim, F., J. Godwin, E. R. Westwater, Y. Han, S. Keihm, K. Marsh, and R. Ware, Radiometric profiling of temperature, water vapor and cloud liquid water using various inversion methods, *Radio Science*, 33, 393-404, 1998a.
- Solheim, F., and J. Godwin, Passive ground-based remote sensing of atmospheric temperature, water vapor, and cloud liquid water profiles by a frequency synthesized microwave radiometer, *Meteorol. Zeitschrift*, N.F.7, 370-376, 1998b.
- Westwater, E., The accuracy of water vapor and cloud liquid determination by dual-frequency ground-based microwave radiometry, *Radio Science*, 13, 667-685, 1978.
- Westwater, E., Ground-based passive probing using the microwave spectrum of oxygen, *Radio Science*, 69D, 1201-1211, 1965.

3. Instrument Hardware

3.1 Overview

RPG-HATPRO

Fig.3.1 shows a schematic drawing of the inner HATPRO radiometer components. The following functional blocks can be identified:

- Receiver optics comprising a corrugated feedhorn (encapsulated in thermal insulation) for each frequency band and off axis paraboloid (scanning mirror)
- Two receiver units (22.24-31.4 GHz, 51.3-59 GHz)
- The ambient load as part of the calibration system
- The internal scanning mechanism
- The instrument electronics sections
- Data acquisition system

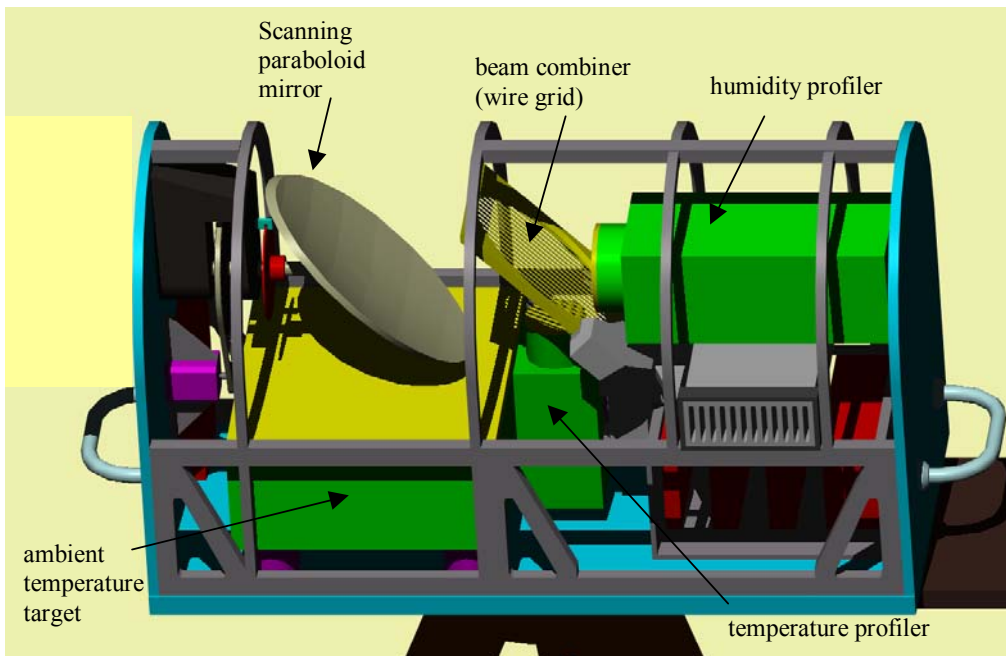

Fig. 3.1: Internal structure of the RPG-HATPRO radiometer.

The optical section is optimized for a beam of approximately 3.5° HPBW (humidity profiler) and 2.5° (temperature profiler) with less than -30 dB side-lobe level. It avoids dielectric lossy elements (like lenses) which helps to reduce standing wave problems within the quasi-optics and improves the radiometer stability and calibration accuracy. The corrugated feedhorn offers a low cross polarization level and a rotationally symmetric beam pattern.

The beams of the two profilers are superimposed by a polarizer wire grid and reflected via an off-axis paraboloid mirror (Fig.3.1). This paraboloid is also used for elevation scanning and calibration. The ambient temperature precision calibration target is sitting below the scanning mirror while an external target is needed as a liquid nitrogen cooled calibration standard for absolute calibration.



The receivers are integrated with their feedhorns and are thermally insulated to achieve a high thermal stability.

HATPRO Environmental Characteristics:

Parameter	SOW Requirement	HATPRO Specification
Temp. range (operational)	-40°C to 45°C	-40°C to 45°C
Temp. range (survival)	-50°C to 50°C	-50°C to 50°C
Wind speed (operational)	90 km/hr	up to 150 km/hr
Wind speed (survival)	140 km/hr	up to 150 km/hr
Rel. Humidity	0...99%	0...100%
Dimensions	Transportable by van	1150 mm x 650 mm x 360 mm
Weight	TBD	~ 60 kg
Power dissipation	2000 VA Max	< 300 Watt
GPS clock	yes	yes
External sensors	air temperature, air total pressure, rel. humidity, rain sensor	air temperature, air total pressure, rel. humidity*

* Because a rain gauge for measuring rain fall rate would need to be placed in a larger distance to the ATPROP system in order to get an undisturbed measurement, no integration of a gauge with ATPROP is implemented.

RRG-15-90

In contradiction to the RPG-HATPRO radiometer the two beams of the R15/90 receivers are not superimposed by a wire grid beam splitter (the grid would be too large). Instead two synchronously scanning parabola mirrors with parallel rotation axes are scanning the beams of both feed horns across the sky. This configuration is possible because the beam divergence (HPBW) of the 90 GHz parabola antenna is only 2.0° so that it fits between the 15.3 GHz parabola antenna and feed horn. The HPBW of the 15.3 GHz beam is 6.2°. As can be seen from Fig. 16 the ambient temperature calibration target is omitted. The Dicke switches in both receivers are used as ambient temperature targets instead.

The implemented Dicke switches are realized as Faraday rotator isolators that are periodically switched during measurement operation. Since the brightness temperature of the internal termination is equivalent to its physical temperature, the Dicke switch represents an absolute calibration standard. The advantage of these devices is their fast operation without moving the system away from the scene. In combination with the noise standards the radiometer can be fully calibrated continuously during observations. Dicke switches have also been implemented in the HATPRO design. Due to the relatively small ambient temperature target at K-band and V-band frequencies the implementation of that target is compatible with the design of a portable instrument. This is not the case for a system operated at 15 GHz. The beam divergence is almost twice as high as at K-band and the required target would be much bigger and lead to higher weight of the instrument's housing.

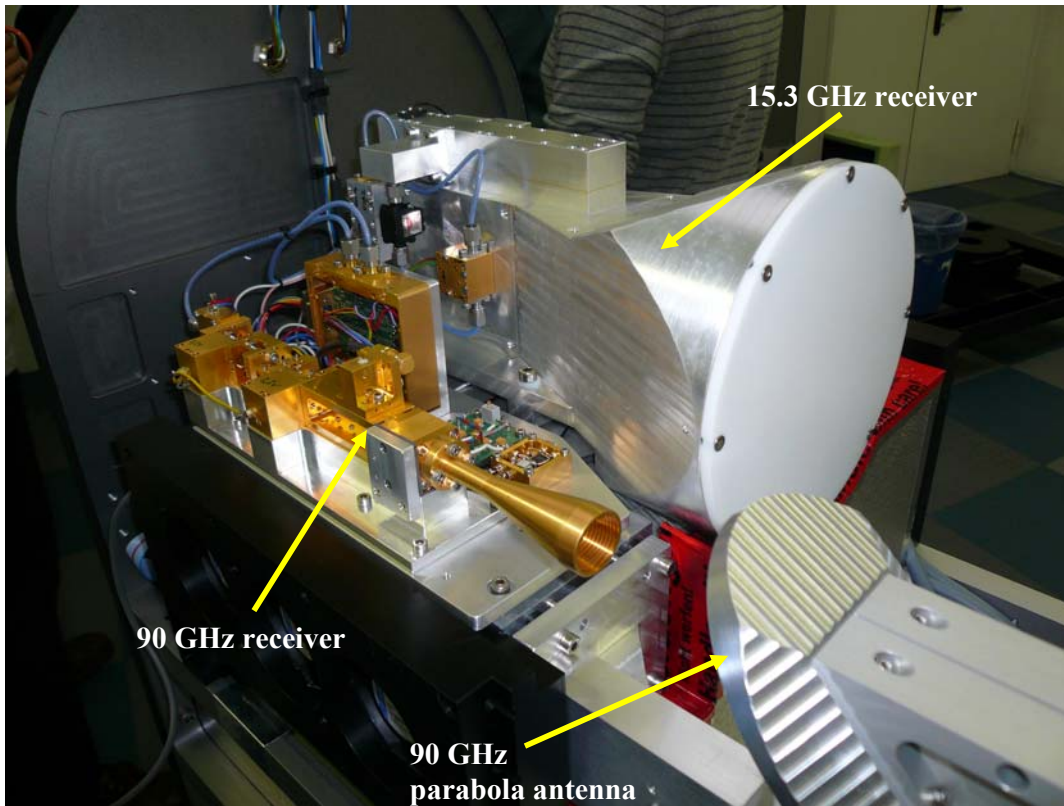

15.3 / 90 GHz receiver

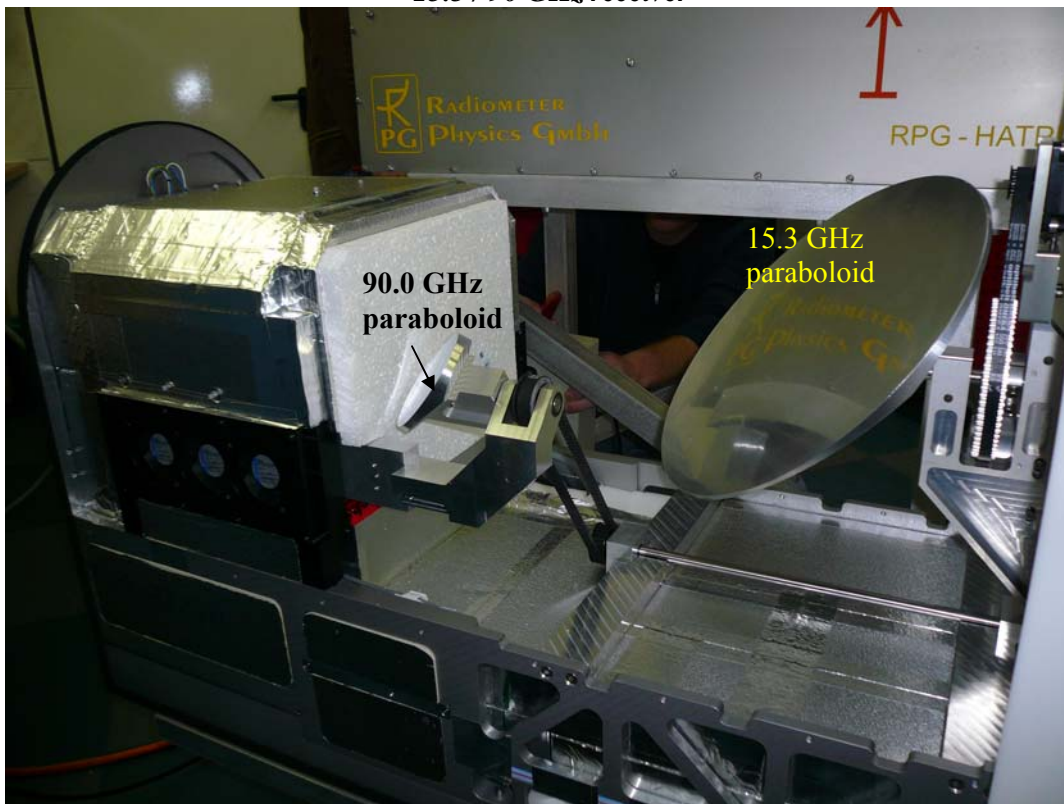

R15/90 15.3 GHz and 90 GHz direct detection receivers and their associated synchronously scanning parabola mirrors.

R15/90 Environmental Characteristics:

Parameter	SOW Requirement	R10/90 Specification
Temp. range (operational)	-40°C to 45°C	-40°C to 45°C
Temp. range (survival)	-50°C to 50°C	-50°C to 50°C
Wind speed (operational)	90 km/hr	up to 150 km/hr
Wind speed (survival)	140 km/hr	up to 150 km/hr
Rel. Humidity	0...99%	0...100%
Dimensions	Transportable by van	1150 mm x 450 mm x 360 mm
Weight	TBD	~ 50 kg
Power dissipation	2000 VA Max	< 300 Watt
GPS clock	yes	no – see HATPRO
External sensors	air temperature, air total pressure, rel. humidity, rain sensor	no – see HATPRO

The total weight of the system is approximately 300 kg. In addition to the radiometers with about 110 kg, including two dew blowers and heaters, an azimuth drive with about 100 kg and a stand. The design will be modular to allow transportation by a van.

3.2 Receivers

The ATPROP receiver concept is motivated by the following design goals:

- The design of the receiver section focuses on maximum thermal and electrical stability, a compact layout with a minimum of connectors and thermally drifting components, an integrated RF design, low power consumption and weight.
- The receivers comprise a reliable calibration system with precision secondary standards. The accuracy of calibration target temperature sensors and the minimization of thermal gradients are critical items to achieve an absolute brightness temperature accuracy of 1K.
- In addition to the measurement of humidity and temperature profiles it is desirable to also derive propagation parameters like attenuation, wet delay, LWP and IWV data from the water vapour line spectrum. Since LWP is a rapidly varying parameter when clouds are passing the field of view, a high temporal resolution in the order of seconds is required to resolve the variability of LWP. Thus the water vapour line is scanned as fast as possible (1 second).

Fig.3.2a shows a schematic of the HATPRO receiver system. At the receiver inputs a Dicke switch provides an internal calibration reference and a directional coupler allows for the injection of a precision noise signal generated by an on/off switching calibrated noise source. This noise signal is used to determine system non-linearities (four point method, described in section ‘Calibration’) and system noise temperature drifts during measurements.

A 60 dB low noise amplifier (LNA) boosts the input signal before it is split into 8 branches (only 7 are currently used). The splitters implement waveguide bandpass filters (BPF) with bandwidths and centre frequencies listed in table 3.1a.

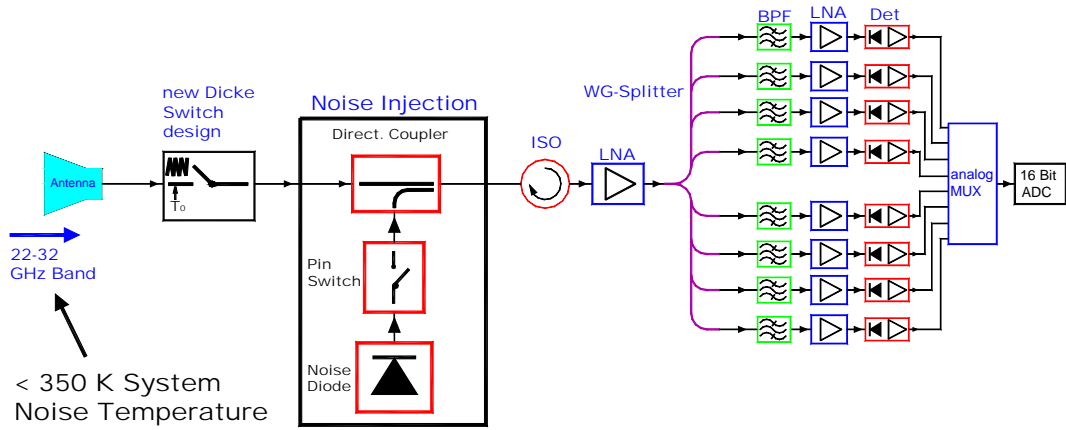

Fig.3.2a: RPG-HATPRO schematic receiver layout. Both receivers are direct detection systems without the need for local oscillators and mixers.

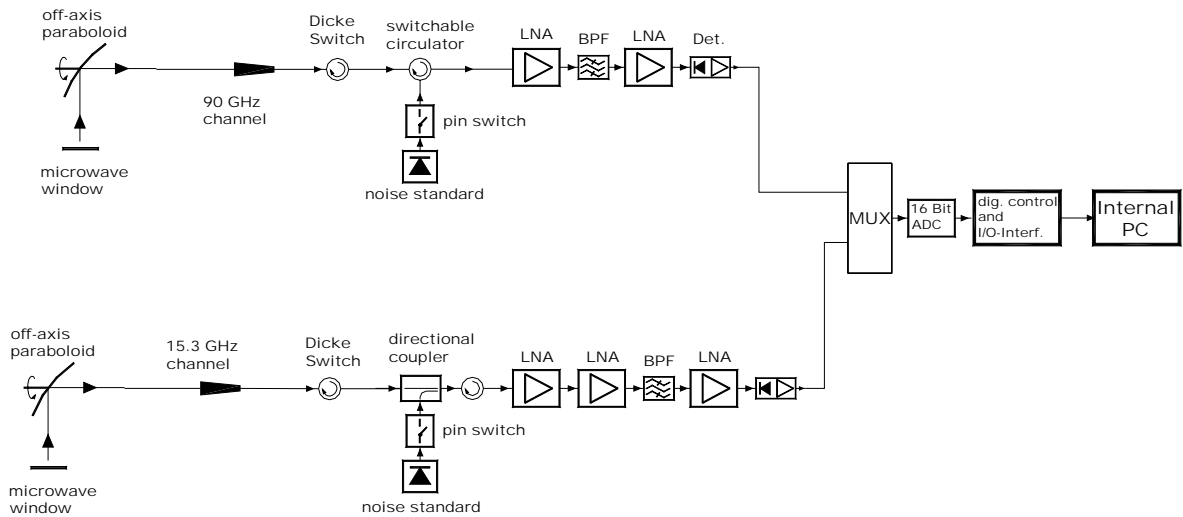

Fig.3.2b: RT15/90: 15.3 GHz and 90 GHz direct detection receivers.

f_c [GHz]	22.24	23.04	23.84	25.44	26.24	27.84	31.40	51.26	52.28	53.86	54.94	56.66	57.30	58.00
b [MHz]	230	230	230	230	230	230	230	230	230	230	230	600	1000	2000

Table 3.1a: RPG-HATPRO channel centre frequencies and corresponding bandwidths.

Fig.3.2b shows a schematic of the RPG-15-90 receiver system. Its receiver concept is equivalent to the one described for the RPG-HATPRO.

The Dicke switch in ON position terminates the receiver inputs with an absorber which is stabilized at ambient temperature. Therefore it can be used as a calibration target (instead of the quasioptical built-in target. The advantage is that the radiometer can continuously perform a full auto-calibration (see section 4.5) while pointing to the scene direction. The elevation mirror does not have to be moved to a target away from the scene. This is ideal for the continuous (interruption free) observation of attenuation / wet delay / LWP time series with high temporal resolution.

In OFF position the DS is passing the scene signal to the receiver input. A very low DS transmission loss is important in order to maintain a high receiver sensitivity. Typical DS transmission losses are in the order of 0.5 to 1.0 dB.



Fig.3.2c: Left: Narrow band 90 GHz y-junction Dicke Switch (transmission loss 0.6 dB, right: Full W-band Faraday Dicke Switch (transmission loss 1.0 dB).

Each channel has its own detector diode. This allows for a parallel detection and integration of all ATPROP channels which implies a fast scanning of the water vapour and oxygen lines. The detector outputs are amplified by an ultra low drift operational amplifier chain and multiplexed to a 16 bit AD converter.

The ATPROP receivers are based on the direct detection technique without using mixers and local oscillators for signal down conversion. Instead the input signal is directly amplified, filtered and detected. The advantages over a heterodyne system are the following:

- No mixers and local oscillators required (cost reduction)
- Local oscillator drifts in amplitude and frequency avoided (stability improvement)
- Mixer sideband filtering not required (cost reduction)
- Reduced sensitivity to interfering external signals (mobile phones etc.) due to avoidance of frequency down conversion

The filterbank concept (parallel channel layout) has the following advantages over sequentially scanning radiometers (e.g. synthesizer sweeping receivers, spectrum analysers):

- Simultaneous measurements of all frequency channels
- Much higher temporal resolution for all products (1 second)
- 7 times faster calibration procedures
- Individual channel bandwidth selection (important for boundary layer temp. profiling)

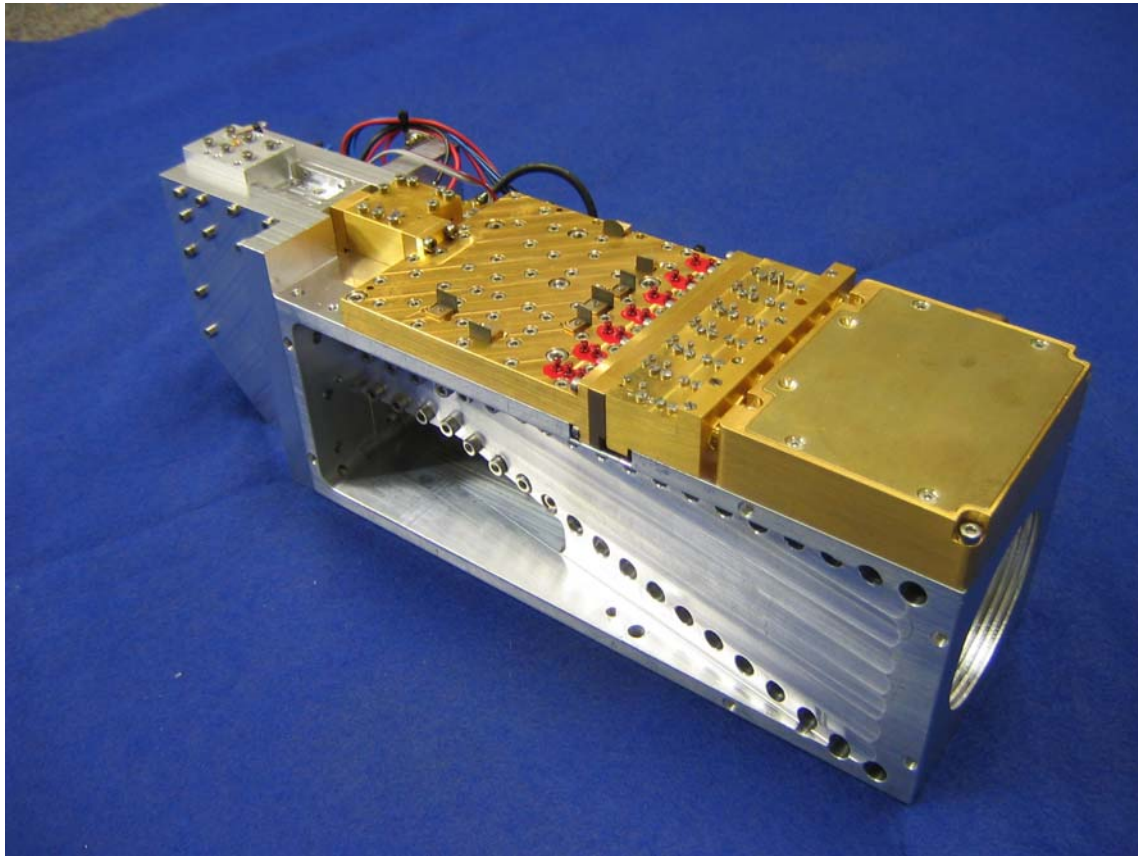

Fig.3.3: Temperature profiling direct detection filterbank receiver mounted to the 50-60 GHz corrugated feedhorn. Receiver size: 72 x 200 x 15 mm³.

Fig.3.3 shows the compact realization of the temperature profiler receiver/feedhorn combination. A high integration level is achieved due to the use of state of the art low noise amplifier MMICs for the 20-30 GHz and 50-60 GHz ranges, which offer superior sensitivity performance compared to direct mixers.

The two independent filter banks allow a completely parallel operation of both profilers which reduces measurement time of humidity and temperature profiles to a minimum. It has been shown in field campaigns that the temporal resolution of such profile measurements should be in the order of 30 to 60 seconds per cycle because water vapour can be quite variable (e.g. cloud forming convection cells). The filter bank design gives superior performance compared to synthesizer controlled receivers because the spectrum is acquired much faster (in one step instead of sequentially switching the channels by a synthesizer). The measurement duty cycle is 100% which is also beneficial for all calibration procedures. A gain calibration takes only 20 seconds with a filter bank receiver but 140 (!) seconds with a synthesizer controlled radiometer.

The total power consumption of both receiver packages is < 3 Watts. This includes biasing of RF- and DC- amplifiers, noise diodes, ADCs and digital control circuits. The low consumption simplifies the thermal receiver stabilization with an accuracy of < 0.05 K over the whole operating temperature range (-30°C to +45°C).

3.3 Detailed Description of Receiver Components

3.3.1 Antenna Performance

To meet the optical requirements of minimum reflection losses and compactness a corrugated feedhorn is an optimal choice. It offers a wide bandwidth, low cross polarization level and a rotationally symmetric beam. Corrugated feedhorns can be designed for a great variety of beam parameters. The horn should be as small as possible to reduce weight and costs.

In order to generate a beam with the desired divergence ($2.5^\circ - 3.5^\circ$ HPBW) a focussing element is needed. The use of a lens in front of the feedhorn is not ideal since it introduces reflections at the dielectric surfaces and losses inside the dielectric. An off axis paraboloid has negligible losses and can simultaneously be used to scan the beams in elevation.

The sidelobe levels produced by the feedhorn/paraboloid system should be below -30 dBc so that brightness temperature errors can be kept < 0.2 K in the case that the sidelobe crosses the sun. A HPBW close to 3° is a compromise with respect to spatial resolution on one hand and to the design of a compact, portable instrument for field campaigns on the other hand.

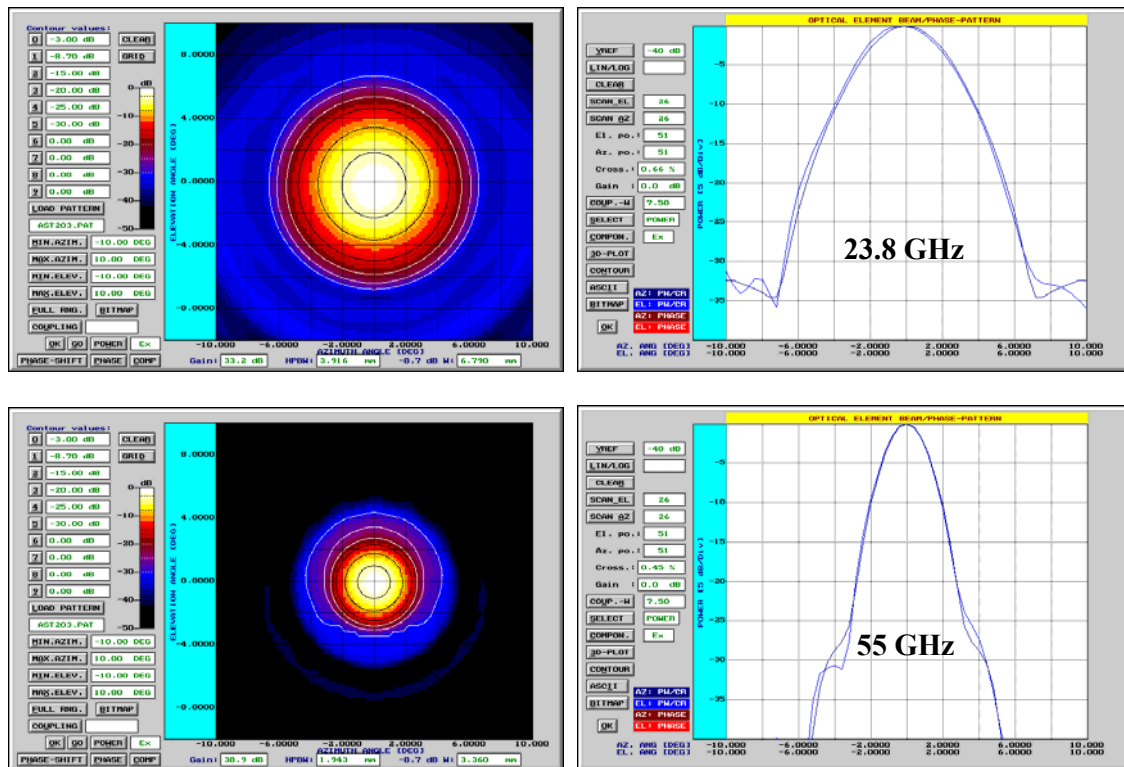

Fig.3.4: Left: 2d amplitude distributions of the paraboloid/corrugated feed @ 23.8 and 55 GHz. Right: H- and E-plane cuts.

The parabola antenna covers a projected diameter of 250 mm.

Frequency [GHz]	22-31	51-59
sidelobe level [dBc]	<-30	<-50
directivity [dB]	33.2	38.9
HPBW [°]	3.3-3.7	2.2-2.5



Table 3.2a: Optical HATPRO antenna performance of corrugated feed / off-axis paraboloid system.

R15/90 - Antenna Performance

It has already been mentioned that no wire grid is used for combining the two beams. Instead each channel is imaged to the sky by its own individual parabola mirror. Calculations of beam parameters are given in Table 3.2b.

Frequency [GHz]	15.3	90
sidelobe level [dBc]	<-30	<-40
directivity [dB]	28.4	33.0
HPBW [°]	6.2	3.0

Table 3.2b: Optical antenna performance of the R15/90 corrugated feed / off-axis parabola system.

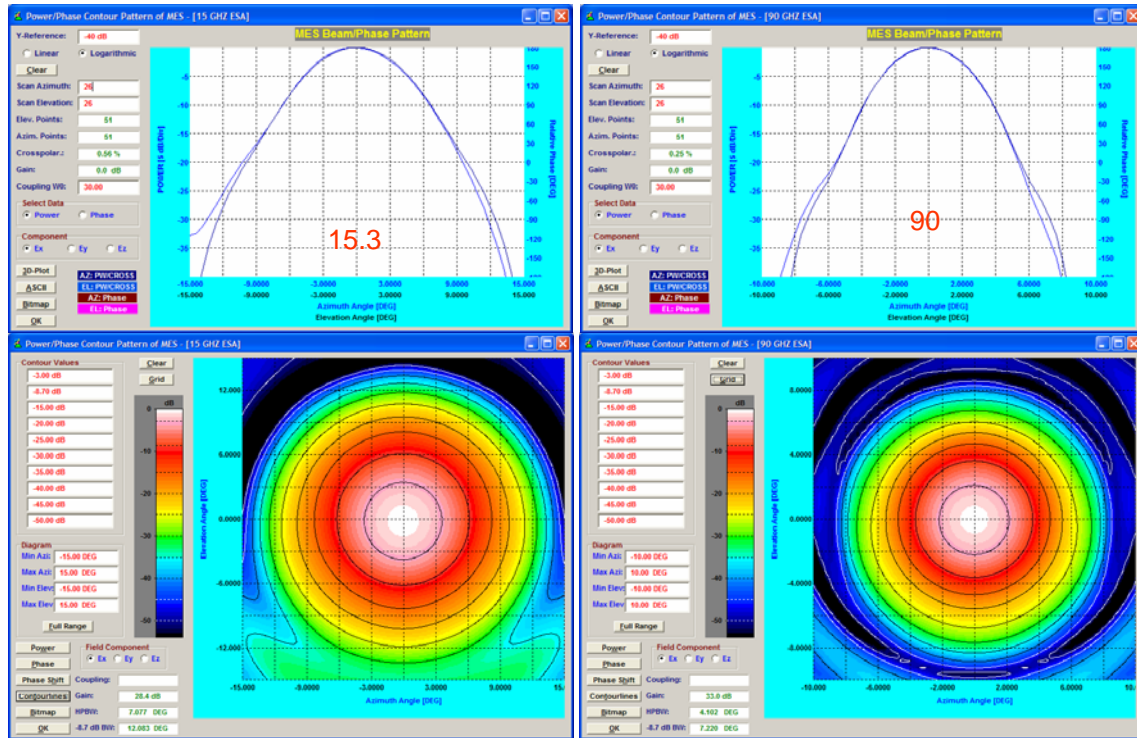

E/H plane cuts of parabola images at 15.3 and 90 GHz.

3.3.2 Noise Diodes

The noise diode is one of the most critical receiver components because the system's brightness temperature critically depends on the calibration reliability. For this reason a careful circuit design and component selection is essential. The noise diode meets MIL-STD202, is hermetically sealed and has been burned in for 170 hours in order to achieve a precisely constant symmetrical white Gaussian noise level. The waveguide circuit layout including a -20 dB directional coupler guarantees the required mechanical stability needed to operate the calibration standard for several month without recalibration. The thermally



stabilized diode is biased by a self adjusting voltage/current source. The directional coupler offers an isolation of >30 dB to the input signal path so that the noise injection does not significantly affect the antenna temperature. The equivalent noise temperature injected by the noise diode is in the range 150K-300K at the isolator input.

3.3.3 RF-Amplifiers

The advances in MMIC technology during recent years have led to low noise amplifiers up to 100 GHz. A key feature of this technology is the possibility of integrating the receiver into a compact planar structure without the need for bulky waveguide designs. In the frequency range between 50 and 60 GHz noise figures of 2.5 dB and bandwidth of 10 GHz are available. Each amplifier comprises a thermal compensation circuit to reduce gain drifts. The amplifier outputs are equipped with isolators to ensure a proper matching between successive stages. Assuming a 2.5 dB noise figure for the first amplifier and additional 2.0 dB for losses in the feedhorn, isolator and directional coupler results in a system noise temperature of 750 K (60 GHz, SSB). With a scene temperature of 300 K the overall RMS noise, assuming a 230 MHz bandwidth and 1 second integration time) is 0.15 K.

3.3.4 Bandpass Filters

The receiver channel bandwidths are determined by waveguide bandpass filters integrated into the filterbank signal splitter section. The 3 pole Chebychev-type filters with 0.2 dB bandpass ripple and 0.5 dB typical transmission loss have a cutoff slope of 20 dB/200 MHz. The high Q design (0.5% rel. bandwidth) is realized by waveguide cavity resonators.

3.3.5 Detector, Video Amplifier, ADC

The zero bias highly doped GaAs Schottky detector diodes can handle frequencies up to 110 GHz with a virtually flat detection sensitivity from 10 GHz to 35 GHz. In addition, the detector diode offers superior thermal stability when compared to silicon zero bias Schottky diodes.

The rectified DC-signal enters an ultra stable OP-Amp circuit with internal analogue integrator. The utilized OP-Amps offer a thermal drift stability of 0.03 $\mu\text{V}/^\circ\text{C}$ which is roughly equivalent to a brightness temperature drift of 10 mK/ $^\circ\text{C}$ assuming a broadband detector with a sensitivity of 1 mV/ μW . The long term stability is 0.2 $\mu\text{V}/\text{month}$.

The 16 bit AD-converter is part of the video amplifier's circuit board to avoid noise from connecting cable pickup. It is optimized for low power dissipation (10 mW) and the high resolution makes a variable offset- and gain-control of the video amplifier superfluous.

The detector, video amplifier and ADC are integrated within a single hermetically shielded unit which is part of the receiver block (thermally stabilized to an accuracy of <0.05K).

3.4 Additional Sensors

Apart from the microwave receivers the RPG radiometers are equipped with the following additional sensors:

Environmental Temperature Sensor: Accuracy: $\pm 0.5^\circ\text{C}$, used to estimate T_{mr} (mean atmospheric temperature) needed for sky tipping calibration procedure.

Humidity Sensor: Accuracy: $\pm 5\%$ relative humidity, used to estimate T_{mr} (mean atmospheric temperature) needed for sky tipping calibration procedure.

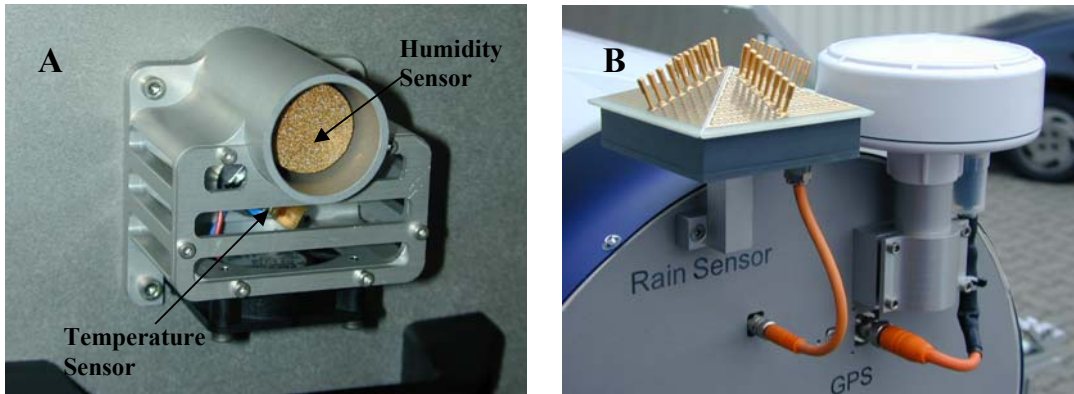

Fig.3.5: External Sensors: A) humidity and temperature sensors, B) rain sensor and GPS receiver.

Barometric Pressure Sensor: Accuracy: ± 1 mbar, used to estimate T_{mr} (mean atmospheric temperature) needed for sky tipping calibration procedure and for the determination of liquid nitrogen boiling temperature (absolute calibration).

Rain Sensor: The rain flag of this sensor is used for all measurements as additional information and for operating the dew blower fan speed.

GPS-Receiver: Receives UTC time and instrument position. Used as time standard for exact temporal synchronization.

Infrared Radiometer: This instrument is attached to the radiometer housing. The interface connection and power supply is provided by the radiometer so that a later upgrade is possible. The operating software supports the use of an infrared radiometer including retrieval development and simple monitoring features.

All meteorological sensors are calibrated without the need for further recalibration. The chemically inert humidity sensor is protected by a sintered and gold plated metal dust filter. The temperature sensor is permanently exposed to a flow of air generated by a fan below the sensor cage to reduce sensor errors caused by self-heating.

An infrared radiometer, when added to the radiometer system, improves the accuracy of humidity profiling and allows for a rough estimate for liquid water profiles and cloud base height.

3.5 Other Radiometer Details

In order to fulfil the requirement of low maintenance regarding absolute calibrations, the instrument is equipped with a two-stage thermal control system for both receivers with an accuracy of ± 0.05 K over the full operating temperature range. Due to this extraordinary high stability the receivers can run freely without any calibration (not even the automatic gain calibration) for 10 minutes while maintaining an absolute brightness temperature accuracy of ± 0.5 K. Each receiver is equipped with a precision noise standard (long term stability) at its signal input which replaces the external cold target in the internal absolute calibration procedure.

The microwave radome is protected from rain drops and dew formation by a powerful dew blower system. A rain detector and a software defined humidity threshold control the dew blower fan speed. Dew formation on the radome can cause significant errors (several K) in the measurement of brightness temperatures.



The system performs many automatic tasks like data interfacing with the external host, data acquisition of all housekeeping channels and detector signals, controlling of elevation stepper, backup storage of measurement data, automatic and absolute calibration procedures, retrieval calculations etc. These tasks are handled by a build in embedded PC with 250 Mbyte disk on module (DOM) for data storage. This PC is designed for operating temperatures from -30°C to 60 °C and is therefore ideal for remote application. The software running on this PC can easily be updated by a password protected file transfer procedure between host and embedded PC.

The host computer software operates under Windows NT4.0, Windows 2000 and Windows XP. A complete host software description is given in chapter 5.

3.6 Instrument Specifications

RPG-HATPRO (tropospheric humidity / temperature profiler):

Parameter	Specification
Humidity profile performance	Vertical resolution: 200 m (range 0-2000 m) 400 m (range 2000-5000 m), 800 m (range 5000-10000 m) Accuracy: 0.4 g/m ³ RMS (absolute hum.) 5% RMS (rel. humidity)
Temperature profile performance	Vertical resolution: BL-Mode: 50 m (range 0-1200 m) Z-Mode: 200 m (range 1200-5000 m) 400 m (range 5000-10000 m) Accuracy: 0.25 K RMS (range 0-500 m) 0.50 K RMS (range 500-1200 m) 0.75 K RMS (range 1200-4000 m) 1.00 K RMS (range 4000-10000 m)
Liquid water profile performance (only with IR radiometer option)	Vertical resolution: 250 m (range 0-2000 m) 300 m (range 2000-5000 m), 500 m (range 5000-10000 m) Accuracy: cloud base height: 50 m (range 0-300 m) 100 m (range 300-1000 m) 200 m (range 1000-3000 m) 400 m (range 3000-5000 m) 600 m (range 5000-10000 m) density: 0.3 g/m ³ RMS Threshold: 50 g/m ² LWP
IR radiometer option	9.2-10.6 μm band, accuracy 1 K, noise: 0.2 K RMS
LWP	Accuracy: +/- 20 g/m ² Noise: 2 g/m ² RMS
IWV	Accuracy: +/-0.2 kg/m ² RMS Noise: 0.05 kg/m ² RMS
Full sky IWV and LWP maps (only with azimuth positioner option)	350 points in 6 minutes rapid scanning
Satellite tracking mode	Determines wet/dry delay and atmospheric



(only with azimuth positioner option)	attenuation along line of sight for all visible GPS / Galileo satellites in a single scan (2 minutes)
Channel center frequencies	K-Band: 22.24 GHz, 23.04 GHz, 23.84 GHz, 25.44 GHz, 26.24 GHz, 27.84 GHz, 31.4 GHz V-Band: 51.26 GHz, 52.28 GHz, 53.86 GHz, 54.94 GHz, 56.66 GHz, 57.3 GHz, 58.0 GHz
Channel bandwidth	2000 MHz @ 58.0 GHz, 1000 MHz @ 57.3 GHz, 600 MHz @ 56.66 GHz, 230 MHz @ all other frequencies
System noise temperatures	<400 K for 22-31 GHz profiler, <700 K for 51.4-58.0 GHz profiler
Radiometric resolution	K-Band: 0.10 K RMS, V-Band: 0.20 K RMS @ 1.0 sec integration time
Absolute brightness temperature accuracy	0.5 K
Radiometric range	0-800 K
Absolute calibration	with internal ambient & external cold load
Internal calibration	gain: with internal noise standard system noise: Dicke switches abs. cal. of humidity profiler: sky tipping calibration
Receiver and antenna thermal stabilization	Stability better than 0.03 K over full operating temp. range
Gain nonlinearity error correction	Automatic, four point method
Brightness calculation	based on exact Planck radiation law
Integration time	>=0.4 seconds for each channel, user selectable
Sampling rate for profiles	> 1 sec, user selectable
Rain / fog mitigation system	High efficient blower system (130 Watts), hydrophobic coated microwave transparent window, 1.8 kW heater module preventing formation of dew under fog conditions
Data interface	RS-232, 115 kBaud
Data rate	10 kByte/sec., RS-232
Instrument control (external)	Host: Industrial PC, temp. range -10°C to +60°C, 4 x RS232, 2 x LAN, 2 x USB
Instrument control (internal)	Embedded PC, controls all internal calibrations, data acquisition, data file backup on 1 Gbyte flash memory, control of azimuth positioner, communication with host, can run measurements independently from host PC
Housekeeping	all system parameters, calibration history documentation
Retrieval algorithms	neural network, lin. / nonlin. regression algorithms
Optical resolution	HPBW: 3.5° for water vapour, 1.8° for temperature profiler
Sidelobe level	<-30dBc
Pointing speed (elevation)	45°/sec
Pointing speed (azimuth), optional	40°/sec



Operating temperature range	-40°C to 45°C
Power consumption	<120 Watts average, 350 Watts peak for warming-up (without dew blower heater), blower: 130 Watts max.
Lightning protection	Power line: circuit breakers Data line: Fiber optics data cable (max. length: 1400 m)
Input voltage	90-230 V AC, 50 to 60 Hz
Weight	60 kg (without dew blower)
Dimensions	63x36x90cm ³

RPG-15-90:

Parameter	Specification
LWP	Improved accuracy from 90 GHz channel: +/- 10 g/m ² Noise: 1 g/m ² RMS
Channel center frequencies	K-Band: 15.3 GHz, 90.0 GHz,
Channel bandwidth	200 MHz @ 15.3 GHz, 2000 MHz @ 90.0 GHz
System noise temperatures	<800 K
Radiometric resolution	0.20 K RMS
Absolute brightness temperature accuracy	1.0 K
Radiometric range	0-800 K
Absolute calibration	with internal ambient & external cold load, sky tipping
Internal calibration	gain: with internal noise standard system noise: Dicke switches abs. cal. of humidity profiler: sky tipping calibration
Receiver and antenna thermal stabilization	Stability better than 0.05 K over full operating temp. range
Gain nonlinearity error correction	Automatic, four point method
Brightness calculation	based on exact Planck radiation law
Integration time	>=0.4 seconds for each channel, user selectable
Rain / fog mitigation system	High efficient blower system (130 Watts), hydrophobic coated microwave transparent window, 1.8 kW heater module preventing formation of dew under fog conditions
Data interface	RS-232, 115 kBaud
Data rate	10 kByte/sec., RS-232
Instrument control (external)	Host: Industrial PC, temp. range -10°C to +60°C, 4 x RS232, 2 x LAN, 2 x USB
Instrument control (internal)	Embedded PC, controls all internal calibrations, data acquisition, data file backup on 1 Gbyte flash memory, control of azimuth positioner, communication with host, can run measurements independently from host PC



Housekeeping	all system parameters, calibration history documen- tation
Retrieval algorithms	lin. / nonlin. regression algorithms
Optical resolution	HPBW: 6.2° @ 15.3 GHz, 3.0° @ 90.0 GHz
Sidelobe level	<-30dBc
Pointing speed (elevation)	45°/sec
Pointing speed (azimuth), optional	40°/sec
Operating temperature range	-40°C to 45°C
Power consumption	<120 Watts average, 350 Watts peak for warming-up (without dew blower heater), blower: 130 Watts max.
Lightning protection	Power line: circuit breakers Data line: Fiber optics data cable (max. length: 1400 m)
Input voltage	90-230 V AC, 50 to 60 Hz
Weight	60 kg (without dew blower)
Dimensions	63x36x90cm ³

4. Calibrations

Calibration errors are the major source of inaccuracies in radiometric measurements. The standard calibration procedure is to terminate the radiometer inputs with two absolute calibration targets which are assumed to be ideal targets, meaning their radiometric temperatures are equal to their physical temperature. This assumption is valid with reasonable accuracy as long as proper absorber materials are chosen for the frequency bands in use and barometric pressure corrections are applied to liquid coolants in the determination of their boiling temperature.

4.1 Absolute Calibration

A calibration target is considered to be an absolute standard when it is not calibrated by another standard. The ATPROP system is shipped with two calibration targets of this category.

4.1.1 The Internal Ambient Temperature Calibration Target

The ambient temperature load is one of the instrument's key components. The pyramidal absorber material is made from carbon loaded foam with low thermal capacity. The target is hermetically isolated by low and high density styrofoam with no exchange of air between the interior and environment (see Fig.4.1). The air within the styrofoam box is dried with silica desiccant to avoid condensation of water on the inner styrofoam surfaces. Most important for the cancellation of thermal gradients across the load is the closed cycle venting of the enclosed air as indicated in Fig.4.1. The foam absorber is perforated between the pyramids so that air from the bottom of the absorber can flow into the volume above the pyramids. The air flow is driven by four miniature fans which maintain a steady exchange of air and thus thermal equalisation of the absorber material.

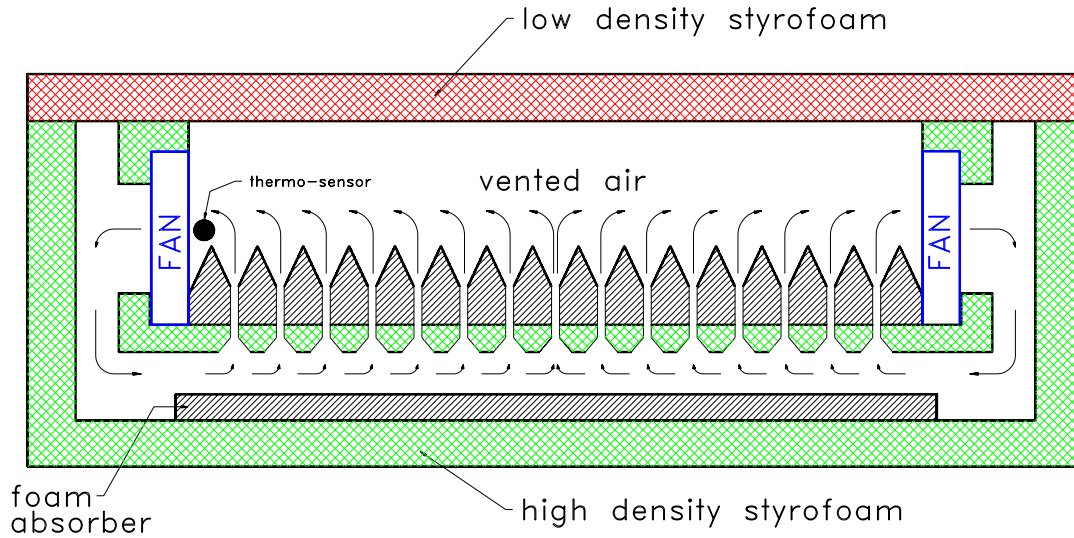

Fig.4.1: Ambient temperature target cross section.

For measuring the precise temperature of the internal calibration load the radiometer is equipped with gauged thermo-sensors offering a guaranteed absolute accuracy of ± 0.1 K. This accuracy is only realistic if the sensor is actively cooled to the air temperature inside the load which is achieved by placing the sensor into the stream of air close to one of the fans. This reduces the internal thermal gradient caused by the sensor's bias current. The top isolation plate is made from low density styrofoam with negligible microwave absorption at frequencies up to 100 GHz.

The major advantage of the ambient load is the fact that no active thermal stabilization by heaters or coolers is necessary. For a calibration load it is not essential to keep its temperature constant for all external thermal conditions but to know its precise physical temperature and to keep thermal gradients as small as possible (which is not achieved by heating or cooling the load from the bottom!). According to these requirements the described load is almost ideal. Furthermore the load has a minimized weight since it is mainly made of styrofoam and foam absorber.

4.1.2 External Liquid Nitrogen Cooled Calibration Target

Another absolute calibration standard is the liquid nitrogen cooled target that is attached externally to the radiometer box (see Fig.4.2). This standard - together with the internal ambient load - is used for the absolute calibration procedure. The cooled load is stored within a 40 mm thick polystyrene container. 15 litres of liquid nitrogen is needed for one filling.

The boiling temperature of the liquid nitrogen and thus the physical temperature of the cold load depends on the barometric pressure p . The radiometer's pressure sensor is read during absolute calibration to determine the corrected boiling temperature according to the equation:

$$T_c = T_0 - 0.00825 \cdot (1013.25 - p)$$

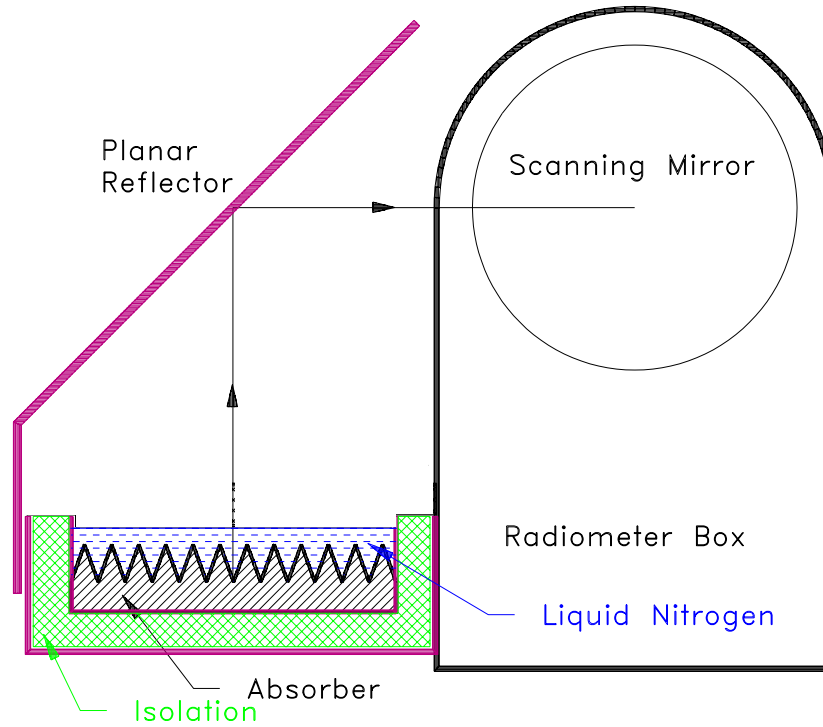

Fig.4.2: External cold load attached to the radiometer box.

where $T_0 = 77.25$ K is the boiling temperature at 1013.25 hPa.

The calibration error due to microwave reflections at the LN/air interface is automatically corrected by the calibration software (embedded PC). It is recommended to wrap a plastic foil around the load+radiometer (wind protection) during absolute calibration to avoid the formation of condensed water above the liquid surface (caused by wind etc.).

4.1.2.1 Assembly of the LN Cooled Target for HATPRO Radiometer

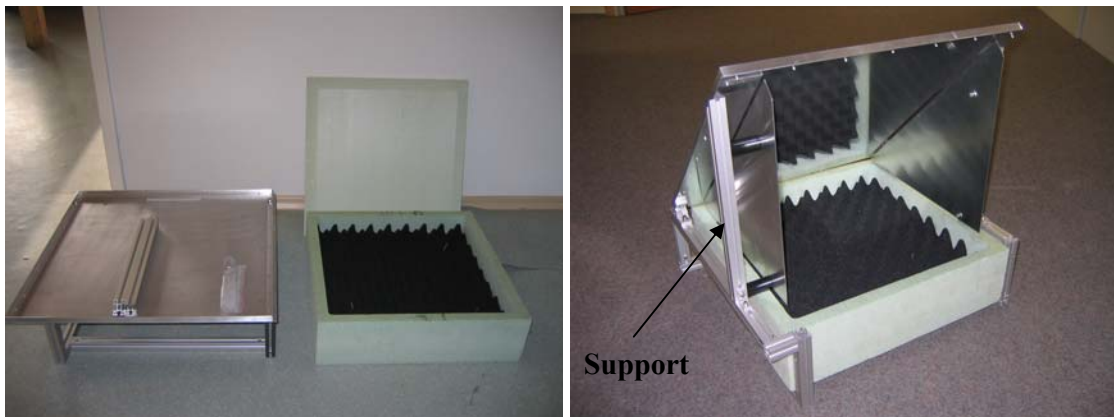

Fig.4.3: External absolute calibration target (cold load).

The external absolute calibration target consists of a frame that holds the liquid nitrogen container and 90° planar reflector.

The 90° planar mirror rests on two supports that have to be mounted to the target frame as is shown in Fig.4.3 and Fig.4.4.

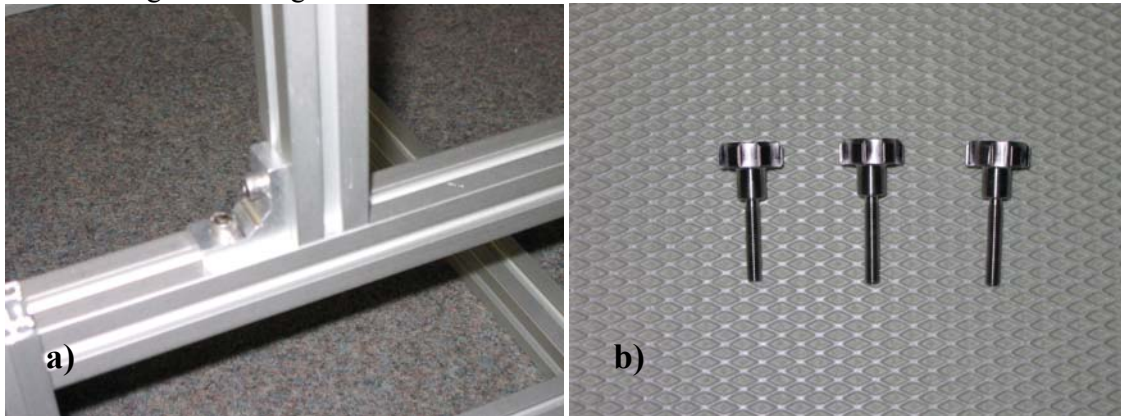

Fig.4.4 a) mounting the support posts to the target frame. b) Screws for mounting target to radiometer housing.

Once the target frame is set up it can be fastened to the radiometer housing. The target frame is mounted on the radiometer side marked with a red arrow (observation side). Two hand screws (from accessory box) are needed to do this (Fig. 4.5.a).

The styrofoam container is then pushed into the frame. Do not push the target completely into the frame to allow for filling the LN into it (Fig. 4.5.b). For filling the target with liquid nitrogen the following procedure is recommended:



Fig.4.5a: location of mounting screws for the target frame.

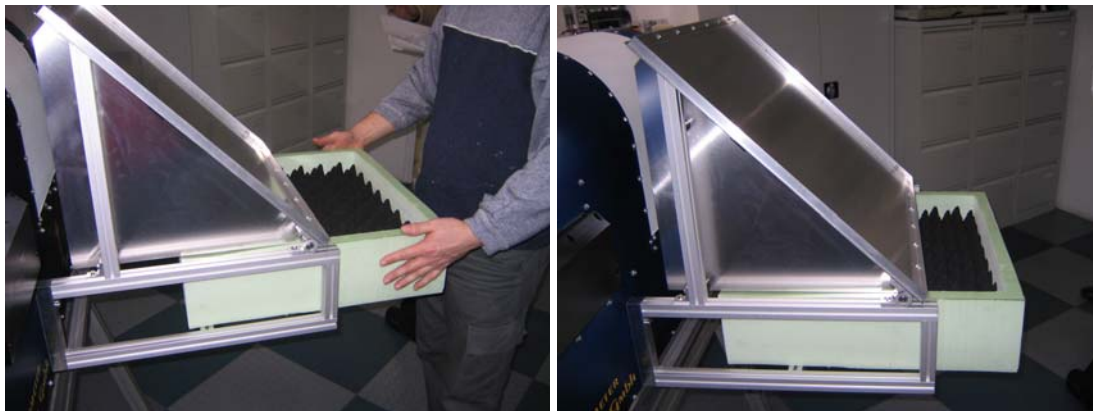

Fig.4.5b: Pushing the target into the frame.

Start with pouring the liquid nitrogen into the small Styrodur container included in the accessories. Then use the container to fill the target as indicated in Fig. 4.5.c. This is repeated 2-3 times until the target is filled to a level where the absorber tips disappear in the liquid. The target must then be pushed into the frame until it touches the radiometer housing (Fig.4.5.d).



Fig.4.5c: Filling the target step by step.

Note: Handling liquid nitrogen without protection like gloves, goggles, aprons etc. is riskful and can lead to serious injuries. We strongly recommend to wear these protection items while doing the calibration. Only trained personal should be allowed to handle LN. Without wearing gloves, goggles and aprons the user is acting on his own risk.



Fig.4.5d: Push the target to its final position.

When the calibration is performed inside a building, a wind protection is probably not required. For outdoor calibration we recommend to cover the whole instrument with a blanket during calibration in order to prevent the production of excessive fog over the target (wind) which may reduce the calibration accuracy.

Refer to section '5. Software Description' to learn how to start the absolute calibration cycle. When the calibration is finished and the target frame is removed do not forget to screw the protector caps into the open threads (Fig.4.6).



Fig.4.6: After the target frame has been unscrewed the open threads should be protected by plastic caps.

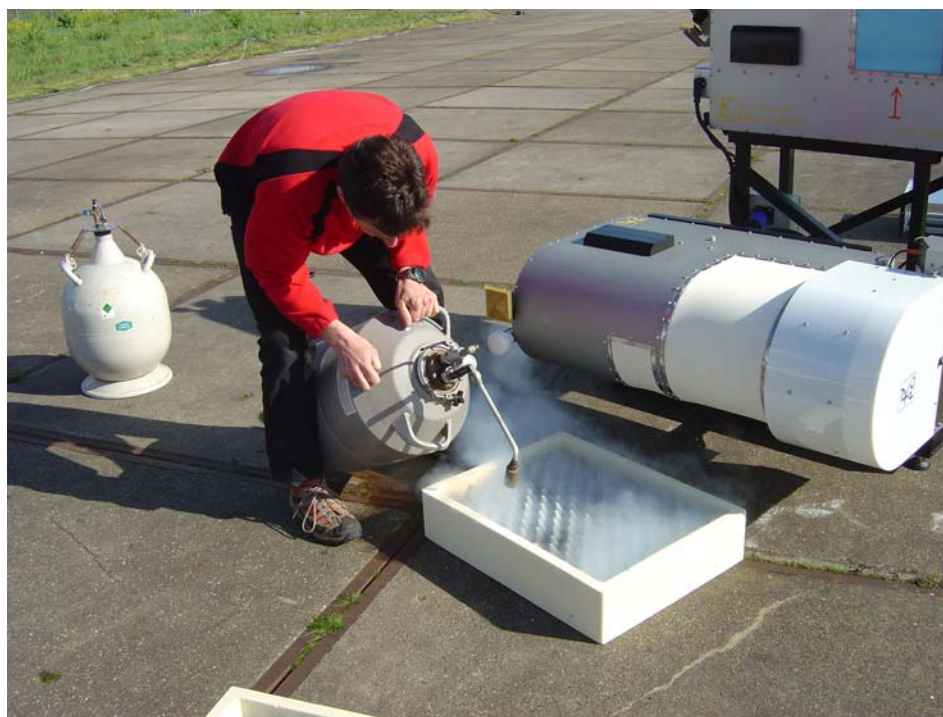

Filling cold target for RPG-15-90 absolute calibration. The radiometer is flipped by 90° to point down to the ground and the target is pushed underneath. The blower should not be removed for this calibration because the flow of air prevents the formation of condensation on the microwave window.

4.1.3 General Remarks on Absolute Calibrations

After the system has been turned on, at least 30 minutes are required for warming up and stabilization of all receiver components. To ensure accurate measurements, an absolute calibration should be performed only after completed warm-up. It is recommended to repeat this calibration every 5 to 6 months of operation or after transportation of the system. This will recalibrate the built-in noise standards needed for the automatic regular calibration cycles.

4.1.3.1 System Nonlinearity Correction

A common simplification in the design of calibration systems for total power receivers is the assumption of a linear radiometer response. In this case a simple two point calibration (hot/cold) is sufficient to determine the system noise equivalent temperature (T_{sys} , offset noise) and system gain (G , slope of the linear response). Accurate noise injection measurements [2], [3] have shown that the assumption of linear system response is not valid in general. Calibration errors of 1-2 K have been observed at brightness temperatures in between the two calibration target temperatures. This system nonlinear behaviour is mainly caused by detector diodes [1] needed for total power detection. Even in the well defined square law operating regime (input power < -30 dBm) the detector diode is not an ideal element with perfect linearity. The noise injection calibration algorithm implemented in all RPG radiometers corrects for these nonlinearity effects.

The system nonlinearity is modelled by the following formula:

$$U = GP^\alpha, \quad 0.9 \leq \alpha < 1 \quad (1)$$

where U is the detector voltage, G is the receiver gain coefficient, α is a nonlinearity factor and P is the total noise power that is related to the radiometric brightness temperature T_R through the Planck radiation law:

$$P(T_R) \cong \frac{1}{e^{\frac{h\nu}{k_B T_R}} - 1}$$

(the proportionality factor is incorporated in G). T_R is the sum of the system noise temperature T_{sys} and the scene temperature T_{sc} .

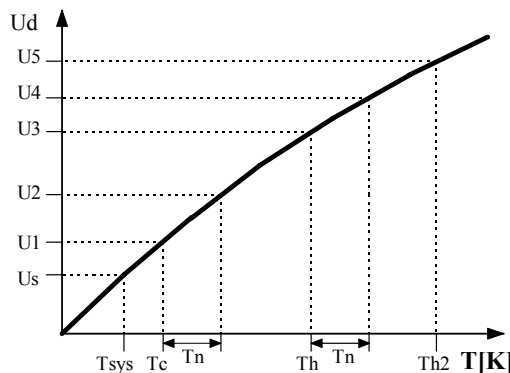

Fig.4.7: Detector response as a function of total noise temperature. T_{sys} is the system noise temperature, T_n the additionally injected noise, T_c the total noise when the radiometer is



terminated with a cold load (e.g. liquid nitrogen cooled absorber) and T_h the corresponding noise temperatures for the ambient temperature load.

The problem is how to determine G , α and T_{sys} experimentally (three unknowns cannot be calculated from a measurement on two standards). A solution is to generate four temperature points by additional noise injection of temperature T_n which leads to four independent equations with four unknowns (G , α , T_{sys} and T_n) The procedure is illustrated in Fig.4.7: During the calibration cycle the elevation mirror automatically scans the two absolute targets. The initial calibration is performed with absolute standards and leads to the voltages $U1$ and $U3$. By injection of additional noise $U2$ and $U4$ are measured. For example $U2$ is given by

$$U_2 = G(P(T_{sys}) + P(T_{cold}) + P(T_n))^\alpha \quad (2)$$

where T_{cold} is the radiometric temperature of the cold target. The evaluation of the corresponding equations for $U1$, $U3$ and $U4$ results in the determination of T_{sys} , G , α and T_n . It is important to notice that the knowledge of the equivalent noise injection temperature T_n is not needed for the calibration algorithm. It is only assumed that T_n is constant during the measurement of $U1$ to $U4$.

After finishing the procedure the radiometer is calibrated. With the four point calibration method also the noise diode equivalent temperature T_n is determined. Assuming a high radiometric stability of the noise injection temperature, following calibrations can use this secondary standard (together with the built-in ambient temperature target) to recalibrate T_{sys} and G (considering α to be constant) without the need for liquid nitrogen.

References

- [1] Cletus A. Hoer, Keith C. Roe, C. McKay Allred, 'Measuring and Minimizing Diode Detector Nonlinearity', IEEE Trans. on Instrumentation and Measurement, Vol. IM-25, No.4, Dec. 1976, page 324 pp.
- [2] Sandy Weinreb, 'Square Law Detector Tests', Electronics Division Internal Report No. 214, National Radio Astronomy Observatory, Charlottesville, Virginia, May 1981
- [3] Hvatum Hein, 'Detector Law' Electronics Division Internal Report No.6, National Radio Astronomy Observatory, Green Bank, West Virginia, Dec. 1962

4.1.3.2 Avoiding Errors from Variable System Noise Temperature

All losses in the receiver system contribute to the system noise temperature. A significant system noise contribution is related to the receiver optics. A corrugated feedhorn operated at 90 GHz has a typical loss of $L=0.5$ dB. At a physical temperature of 300 K such a feedhorn contributes with 30 K to system noise according to the formula

$$T = T_0 \left(1 - \frac{1}{L}\right)$$

where T_0 is the physical temperature of the horn. A change of the feedhorn's physical temperature from 0°C to 30°C leads to a system noise increase of 3 K which corresponds to an error in the absolute brightness temperature. For this reason the antenna has to be thermally stabilized together with the receivers.

The brightness temperature errors introduced by optics that are not thermally stabilized **cannot** be corrected by the implemented noise standard calibration because the noise source power enters the signal path behind the feedhorn and thus is not changed by a variable antenna temperature.

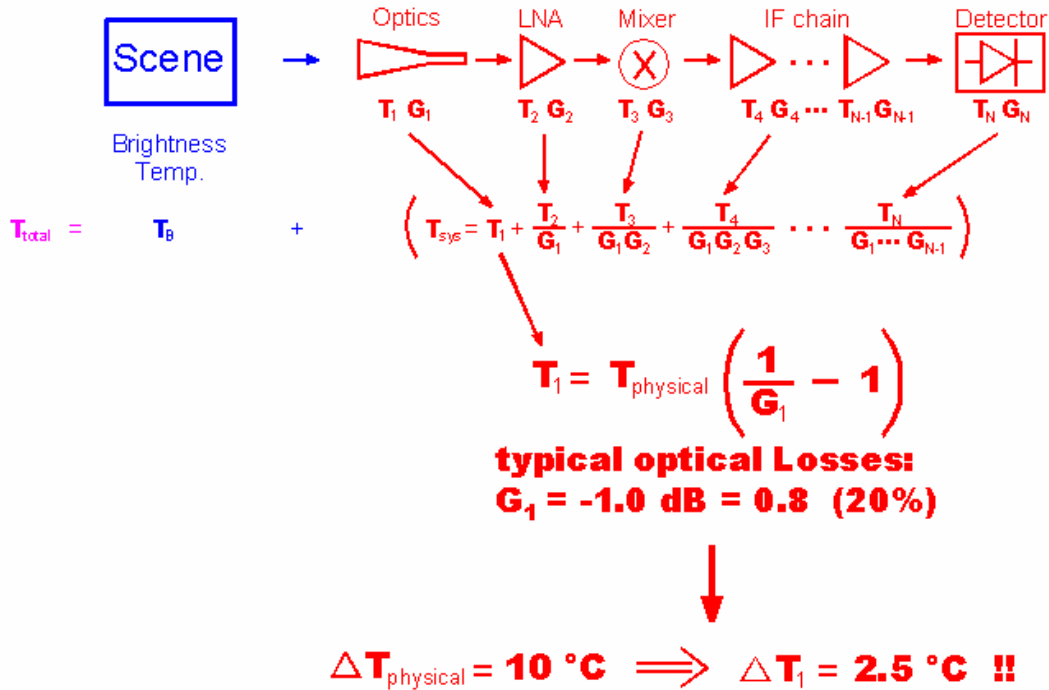

Fig.4.8: Contribution of radiometer components to system noise temperature T_{sys} .

4.2 Noise Injection Calibration

It is not convenient to use a liquid nitrogen cooled load for each calibration. For this reason the radiometer has two built in noise sources (one for each profiler) that can be switched to the receiver inputs. The equivalent noise temperature T_n of the noise diode is determined by the radiometer after a calibration with two absolute standards (hot/cold) and is in the range 100 K to 300 K. The noise diode is also used to correct for detector diode nonlinearity errors. The accuracy of a calibration carried out with this secondary standard and the ambient temperature load is comparable to the results obtained with a liquid nitrogen cooled load. The advantage of the secondary standard is obvious: A calibration can be automatically done at any time. All system parameters are recalibrated including system noise temperatures.

The noise diode is optimized for precision built-in test equipment (BITE) applications and meets MIL-STD202 standard with 170 hours burn-in. This process guarantees highest reliability and performance repeatability. The repeatability error is expected to be $<0.1 \text{ K / month}$.

Due to the fact that only two calibration points are generated with this calibration type (T_a = ambient temperature target, T_{a+n} = ambient temperature target + noise standard), it has to be assumed that the non-linearity factor α does not change with time. This is a reasonable assumption because α is basically an intrinsic detector diode parameter.



The duration of the noise injection calibration is about 60 seconds. It is recommended to repeat it once per day.

4.3 Gain Calibration (Relative Calibration)

The most frequently performed calibration is the gain calibration method. It only corrects for gain drifts (G) but not for changes in system noise temperature T_{sys} . The receiver gain is most sensitive to even small changes in the physical temperature of the receiver components. During calibration the noise diode power is injected into the receiver inputs. With the assumption of constant T_{sys} the system gain can be recalibrated.

4.4 Sky Tipping (Tip Curve)

Sky tipping (often referred to as tip curve calibration) is a calibration procedure suitable for those frequencies where the earth's atmosphere opacity is low (i.e. high transparency) which means that the observed sky brightness temperature is influenced by the cosmic background radiation temperature of 2.7 K. The humidity profiler channels are candidates for this calibration mode. High opacity channels like all temperature profiler channels >53 GHz are saturated in the atmosphere and must be calibrated by other methods.

Sky tipping assumes a homogeneous, stratified atmosphere without clouds or variations in the water vapour distribution. If these requirements are fulfilled the following method is applicable:

The radiometer scans the atmosphere from zenith to around 20° in elevation and records the corresponding detector readings for each frequency. The path length for a given elevation angle α is $1/\sin(\alpha)$ times the zenith path length (often referred to as "air mass"), thus the corresponding optical thickness should also be multiplied by this factor (if the atmosphere is stratified!).

The optical thickness is related to the brightness temperature by the equation:

$$\tau(\infty) = -\ln\left(\frac{T_{mr} - T_i}{T_{mr} - T_{B0}}\right)\sec(\theta)$$

T_{mr} is a mean atmospheric temperature in the direction θ , T_{B0} is the 2.7 K background radiation temperature and T_i is the brightness temperature of frequency channel i . T_{mr} is defined as:

$$T_{mr} = \frac{\int_0^\infty T(z) e^{-\tau(z)} \sigma_a dz}{1 - e^{-\tau(\infty)}}$$

T_{mr} is a function of frequency and is usually derived from radiosonde data. A sufficiently accurate method is to relate T_{mr} with a quadratic equation of the surface temperature measured directly by the radiometer.

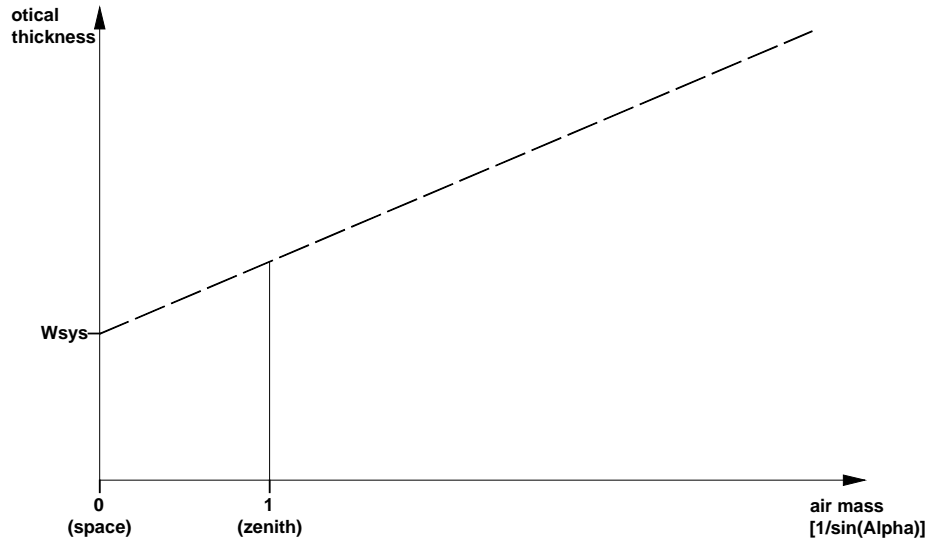

Fig.4.9: Extrapolation of tipping response to 2.7 K free space temperature.

The optical thickness as a function of air mass is a straight line (see Fig.4.9) which can be extrapolated to zero air mass. The detector reading U_{sys} at this point corresponds to a radiometric temperature which equals to the system noise temperature plus 2.7 K: $U_{\text{sys}} = G \cdot (T_{\text{sys}} + 2.7 \text{ K})$. The proportionality factor (gain factor) G can be calculated when a second detector voltage is measured with the radiometer pointing to the ambient target with known radiometric temperature T_a . The sky tipping calibrates the system noise temperature and the gain factor for each frequency without using a liquid nitrogen cooled target.

The disadvantage of this method is that the assumption of a stratified atmosphere is often questionable even with clear sky conditions due to invisible inhomogeneous water vapour distributions (e.g. often observed close to coast lines). The built-in sky tipping algorithm investigates certain user selectable quality criteria to detect those atmospheric conditions that do not fulfil the calibration requirements. The most important criteria are:

- Linear correlation factor. This measures the correlation of the optical thickness samples (as a function of air mass) with a straight line. Typical linear correlation factor thresholds are >0.9995 . The linear correlation factor is not sensitive for the noise of the optical thickness samples caused by clouds etc.
- χ^2 -test. This measures the variance of the optical thickness samples relative to the straight line in Fig.4.9. Typical threshold values are <0.4 for a good quality calibration.

The tip curve calibration is considered to be the most accurate calibration method. The brightness temperatures acquired in the elevation scan are close to the scene temperatures measured during zenith observations.

4.5 Calibration Equations

All RPG radiometers are equipped with noise injection calibration standards. A subset of these also have Dicke switch references like the RPG-150-90 radiometer and a special version



of the RPG-HATPRO. They are referred to as 'Full Dicke Switch' instruments (Type 2, see section 3.2).

Relation between detector voltages U_d and scene temperatures T_{sc} :

$$U_d = G (T_{sys} + T_{sc})^{Alpha} , \text{ for radiometers without Full Dicke Switching Mode (Type 1)}$$

$$U_d = G (T_{sys} + T_{sc}) , \text{ for radiometers with Full Dicke Switching Mode (Type 2)}$$

System Noise Temperature T_{sys} , Noise Diode Temp. T_N and Gain G :

Absolute Calibrations (Hot / Cold): detector voltages on black body target (temperature $T_H = T_{amb}$): U_H , cold target (LN or Skydip, temperature T_C): U_C :

$$Y = (U_H / U_C)^{1/Alpha} , T_{sys} = (T_H - Y * T_C) / (Y - 1) , 0.95 < Alpha <= 1 \text{ (sec. 4.1.3.1), Type 1}$$

$$Y = (U_H / U_C) , T_{sys} = (T_H - Y * T_C) / (Y - 1) , \text{ Type 2}$$

$$G = U_H / (T_{sys} + T_H)^{Alpha} , \text{ Type 1}$$

$$G = U_H / (T_{sys} + T_H) , \text{ Type 2}$$

On black body target (T_{amb}), noise diode turned off: U_{-N} , noise diode turned on: U_{+N}

$$T_N = (U_{+N} / G)^{1/Alpha} - T_{sys} - T_{amb} , \text{ Type 1}$$

$$T_N = (U_{+N} - U_{-N}) / G , \text{ Type 2}$$

Type 2 only: Dicke Switch (DS) ON, radiometer pointing to amb. temp. target:

$$DelT = U_{DS} / G - T_{sys} - T_{DSp} ,$$

Dicke Switch (DS) leakage (Type 2 only): DS ON, radiometer pointing to cold target:

$$Alpha = (T_{DSp} + DelT - (U_{DS} / G - T_{sys})) / (T_{DSp} + DelT - T_C)$$

If a liquid nitrogen cooled target is used, the following correction has to be applied:

$$T_C [K] = 77.36 - 8.2507e-3 * (1013.25 - P) + 1.9 , P \text{ in mbar, } 1.9 \text{ K is correction for surface reflection on LN (n = 1.2)}$$

Continuous full calibration on scene (Type 2 only): Noise Diode turned off: U_{-N} , noise diode turned on: U_{+N} , radiometers looking on scene temperature T_{sc} , Dicke switch turned ON (blocking scene), physical Dicke switch temperature T_{DSp} :

$$G = (U_{+N} - U_{-N}) / T_N , T_{sys} = U_{-N} / G - (T_{DSp} + DelT - Alpha * (T_{DSp} - T_{sc})) , Alpha = \text{DS leakage (determined in absolute calibration)}$$

Continuous noise switching on scene (Type 1 only): noise diode turned off: U_{-N} , noise diode turned on: U_{+N} (10 Hz), radiometers pointing to scene (temperature T_{sc}):

$$D = (U_{+N} / U_{-N})^{1/Alpha} - 1 , T_{sc} = (T_N - D * T_{sys}) / D , G = U_{-N} / (T_{sys} + T_{sc})^{Alpha}$$

$$\text{Calibration on ambient temp. black body target (T}_{amb}): T_{sys} = (U_d / G)^{1/Alpha} - T_{amb}$$

Type 1, no noise switching:

$$\text{gain calibration on ambient temp. target (T}_{amb}): G = U_d / (T_{sys} + T_{amb})^{Alpha}$$

noise calibration on ambient temp. target (T_{amb}):

$$D = (U_{+N} / U_{-N})^{1/Alpha} - 1 , T_{sys} = (T_N - D * T_{amb}) / D , G = U_{-N} / (T_{sys} + T_{amb})^{Alpha}$$



5. Software Description

The following conventions are used in this software description:

- Messages generated by the program that have to be acknowledged are printed in red. Example: *The specified port in 'R2CH.CFG' has no data cable connected to it!*
- Button labels are printed in green: *Cancel*
- Messages that have to be answered by *Yes* or *No* are printed in light blue: *Overwrite the existing file?*
- Labels produced by the software are printed in grey: *UTC*
- Names of group boxes are printed in blue. Example: *Radiometer Status* on the main screen.
- Names of tabs are printed in violet: *Sky Tipping*
- Names of menus are printed in black: *File Transfer*
- When a speed button shall be pressed, this is indicated by its symbol: 
- Hints to speed buttons are printed in brown: *Define Serial Interface*
- Selections from list boxes are printed in magenta: *Celsius*
- Selections from radio buttons or check boxes are printed in dark green: *COM1*
- File names are printed in orange: *MyFileName*
- Directory names are printed in dark blue: *C:\Programs\RPG-HATPRO*

5.1 Installation of Host Software

5.1.1 Hardware Requirements for Host PC

The hardware requirements for running the host software are:

- Pentium based PC, 500 MHz clock rate minimum
- 30 MB free RAM for software execution
- Serial interface (RS-232), 9 pin Sub-D connector

A laptop computer is included in the standard delivery package and pre-installed software comes with it. However the host software R2CH.EXE can be installed and run on any other computer that fulfils the hardware requirements listed above.

5.1.2 Directory Tree

To operate the host software without problems a proper installation of the retrieval files (required to perform online calculations of atmospheric parameters like profiles, LWP, IWV etc.) is required.



By clicking on the desktop icon  the executable host program *R2CH.EXE* is invoked (runs on Windows NT4.0, Windows 2000, Windows XP). On pre-installed PCs this file is located in *C:\Programs\RPG-HATPRO*. This directory path can be changed to any other path (in the following referred to as *MY_DIRECTORY\RPG-HATPRO*). Of course the corresponding desktop link has to be modified accordingly.

In the case that the user wants (or has) to install the software himself the following steps should be performed:

- Start your Windows operating system
- Start the Windows Explorer
- Insert the Radiometer CD-ROM



- In Windows Explorer click on the CD-ROM drive icon
- Click on the **RPG-HATPRO**-folder and drag the whole folder to **MY_DIRECTORY** (user selectable).

Example: If '**MY_DIRECTORY**' is the directory **D:\Programs** the complete tree should look like this:

```
D:
|---Programs
|   |---RPG-HATPRO
|   |   |---DATA
|   |   |---MBFs
|   |   |---MDFs
|   |   |---RADIOMETER PC
|   |   |---TRACKING
|   |   |---RETRIEVALS
|   |       |---ATTENUATION
|   |       |---HPROFILE
|   |       |---IWV
|   |       |---LWP
|   |       |---MISCELLANEOUS
|   |       |---TPROFILE_BL
|   |       |---TPROFILE_TROP
|   |       |---TMR
```

The **RPG-HATPRO** -directory contains the following files:

- **VCL50.BPL** : System library extension file
- **VCLX50.BPL** : System library extension file
- **BORLNDMM.DLL** : Dynamic link library, Memory Management functions
- **CC3250MT.DLL** : Dynamic link library, Core functions
- **INPOUT32.DLL** : Dynamic link library, serial interface access routines
- **NETCDF.DLL** : Dynamic link library, netCDF file format routines
- **R2CH.EXE** : Radiometer software
- **R2CH.CFG** : Radiometer software configuration file
- **COMS.ADR** : Port address file for serial interfaces (plug-in extender boards)

The **MBFs** and **MDFs** directories are empty after installation and are intended for the Measurement Batch Files and Measurement Definition Files needed to initiate a measurement. **DATA** is reserved for measurement data files including user defined sub-directories. Of course the user can create any other directory for his data file storage. **TRACKING** is reserved for RINEX navigation files needed for the satellite tracking mode (see section 5.9.4.2).

RETRIEVALS and its subdirectories should never be changed (renamed or deleted) since the software assumes to find all retrieval files here. The retrievals for humidity profiles are stored in **HPROFILE**, tropospheric retrievals for temperature profiling are stored in **TPROFILE_TROP** etc. When the user develops his own retrieval files he must store the retrieval in one of the 6 category directories.

Click into **MY_DIRECTORY\RPG-HATPRO** and locate **R2CH.EXE**. When clicking on this file with the right mouse button a list of actions is displayed. Select the 'Desktop (Create Shortcut)' option to generate an icon on the desktop.



The **COMS.ADR** is an ASCII file that contains the port addresses (in decimal format) of the serial interfaces available on the host PC. When this file is missing, the software uses the DOS default addresses for COM1: 3F8h, COM2: 2F8h, COM3: 3E8h, COM4: 2E8h. If an extender board for additional RS-232 interfaces is installed in the host PC, the operating system might assign different port addresses to these COM interfaces. Appendix D explains how to find out these addresses and how to modify **COMS.ADR** in order to use these interfaces for radiometer operation.

5.2 Getting Started



When clicking on the desktop icon **RPG** to start the host software (**R2CH.EXE**) the program first tries to locate a data cable connected to any of the RS-232 host serial interfaces. If it does not find a data cable the message **The specified port in 'R2CH.CFG' has no data cable connected to it!** is generated as shown in Fig. 5.1. This message is referring to the file **R2CH.CFG** (located in **MY_DIRECTORY\RPG-HATPRO**) which is a configuration file that is loaded by **R2CH.EXE** at program start. This file contains information (among other data) about the standard serial interface port used for the communication link to the radiometer.

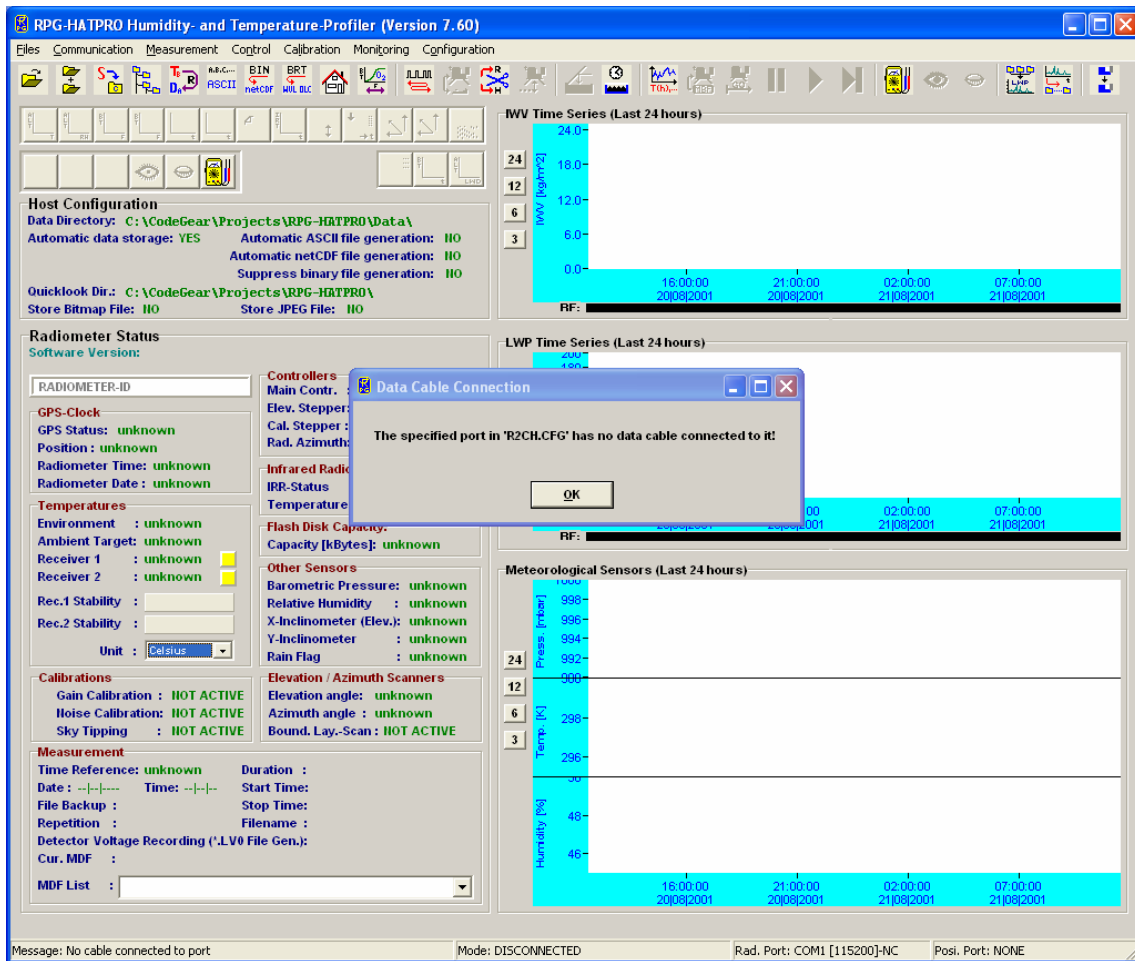



Fig.5.1: Starting host software without a data cable connected to any of the RS-232 interfaces.



For certain reasons it is desirable to operate the software even without a data link to the radiometer. For instance, the user may wish to inspect recorded data files, calibration history or prepare MDFs (Measurement Definition Files) for the next measurements etc. These tasks do not require a radiometer communication link. In this case the message *The specified port in 'R2CH.CFG' has no data cable connected to it!* can be ignored. All commands requiring a radiometer connection are then disabled.

If a data cable is installed between the host and the radiometer (see section 1.6), the user has to define the serial interface parameters for the communication. This is done by clicking  (*Define Serial Interface*). This command opens the menu below.

The selectable COM-ports are enabled in the upper button list. The user can only select one of the available ports for interconnection with the radiometer.

The baud rate parameter defines the communication speed. For cable lengths up to 50 m the highest baud rate should be used (*115200*). This is particularly important when files that have been backed up on the radiometer DOM (disk on module) need to be transferred to the host. Some of these data files might be several MBytes in size so that an optimally fast transfer rate is desirable. At *115200* baud the transfer speed is about 9 kByte/sec.

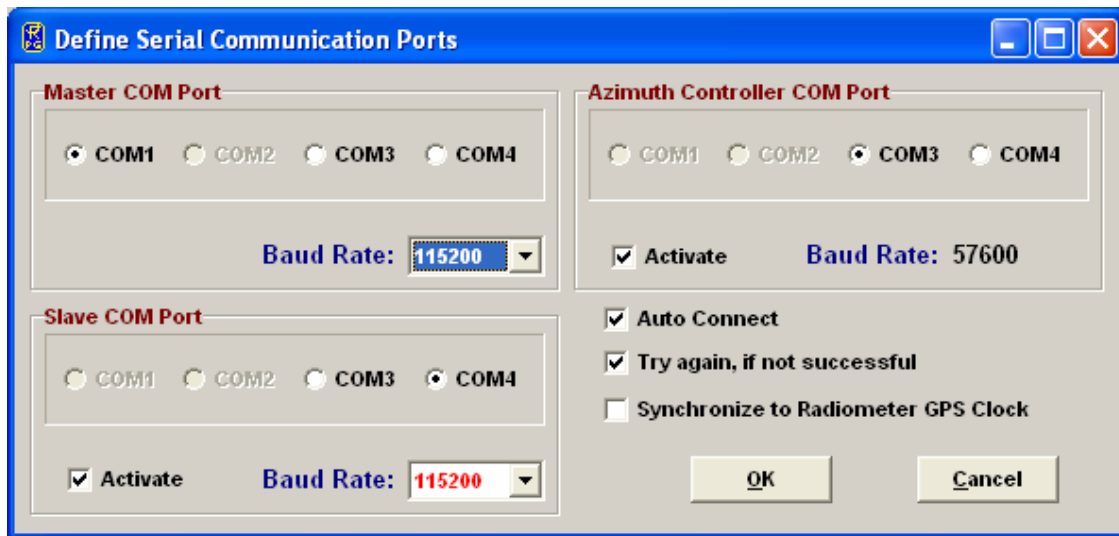

If *Auto Connect* is checked, the host software automatically attempts to connect to the radiometer (if a data cable is detected) when it is started. This feature enables an auto-startup function after a power failure of the host PC. The radiometer embedded PC will automatically continue a measurement when the power returns after a power failure. To start the host software automatically after reboot of the operating system, the *R2CH.EXE* should be entered into the Auto Start directory of the operating system or an appropriate task should be defined in the scheduler.



When using an optional azimuth positioner (see section 8.2) to allow for full sky scanning, the azimuth controller is connected to the host PC through a second RS-232 interface. This interface is also defined in the *Define Serial Interface* menu. The baudrate is fixed to 9600. The automatic controller activation at software start is enabled by checking the *Activate* box. If a first attempt to connect to the radiometer fails, the program can retry a second time if the *Try again, if not successful* is checked. If the user wants to adjust the host PC time by synchronizing it to the radiometer GPS clock he can check *Synchronize to Radiometer GPS Clock*.





A second radiometer (Slave) can be run by the same host program to combine the channels of two systems to a virtually single instrument (Master / Slave operation). In this case the Slave radiometer needs a second serial interface and must be separately activated.

The interface parameters are stored in the configuration file (*R2CH.CFG*) that is loaded each time *R2CH.EXE* is started. This file is backed up on exiting *R2CH.EXE*. A definition of the serial interface parameters is only necessary at the first start of *R2CH.EXE* or when the transfer speed must be reduced due to longer cable length.

The sequence for setting up a communication link to the radiometer is the following:

- Install the interface cable between host and radiometer as described in section 1.6 (the radiometer power has to be turned off).
- Turn on the radiometer power.
- Wait for 2 minutes until the radiometer PC has booted up and the elevation mirror has moved to its index position (the mirror movement is quiet, but easily audible).
- Start the host software (if not already done) and define the serial interface parameters as described above (if necessary).
- The next step is to initiate the communication between the host and radiometer PC by pressing  (*Connect to Radiometer*). *R2CH.EXE* then establishes the same baud rate on the radiometer embedded PC as was selected in *Define Serial Communication Port*. This operation takes a couple of seconds. If successful, the message *Connection to radiometer successfully established. Baud Rate adjusted.* is displayed. Otherwise the message *Radiometer does not respond! Connection could not be established...* appears. In this case try the following to handle the problem:
 - Repeat the  command.
 - If not successful, check the data cable (is it properly connected to host and radiometer?).
 - Check that the radiometer power is turned on.
 - Repeat the turn on procedure.
 - If not successful, contact RPG.

The connection status is displayed in the status bar (bottom line of the main screen) and includes the COM port number and baud rate. The radiometer responds to the host by sending the status report (listed in *Radiometer Status* on the host main screen) comprising its ID, the status of the various controllers/GPS clock, the infrared radiometer status, the system's housekeeping data (temperatures, surface sensor readings, inclination in elevation axis and perpendicular to it), DOM capacity (disk on module, the embedded PC's hard disk) and elevation stepper position. When a measurement is started, additional information is displayed here like the calibration status, reference time and date, the duration of the actual measurement, its start and end time, the measurement filename, whether file backup is enabled on the embedded PC or not and the repetition number of the running batch (explained later). The radiometer status display can be disabled () or enabled () at any time. In general the display should be enabled because certain automatic tasks (like logging of all calibration activities) are only performed when the status display is enabled.

5.3 Radiometer Status Information

The various status displays in the *Radiometer Status* group box are:



- Software Version: Indicates the version number of the radiometer PC software **2CH.EXE** for reference (the host software version is printed in the main window caption).
- Instrument ID: The radiometer identifies itself by sending the instrument ID to the host when a connection is established (e.g. *RPG-HATPRO*, *RPG-LWP*, *RPG-LWP-U*, etc.).
- **Controllers**: Lists the status of the two instrument controllers:
 - The main controller handles all communication activities between the radiometer PC and the radiometer hardware.
 - The elevation stepper controller generates the driving signals for the elevation scanning paraboloid mirror. It also provides the initialization procedure for moving the mirror to its index position at system power up.
- **GPS**: Indicates if a GPS clock is installed or not and the global position of the radiometer location (at least 5 GPS satellites have to be visible to provide this information).

Radiometer Status
Software Version: 5.60

RPG-HATPRO

GPS-Clock
GPS Status: GPS-Rec. active!
Position : 50°38'46"N, 07°01'35"E

Temperatures
Environment : 11.4 °C
Ambient Target: 24.7 °C
Receiver 1 : 41.5 °C
Receiver 2 : 41.8 °C
Rec.1 Stability : 0.002 K
Rec.2 Stability : 0.000 K
Unit : Celsius

Calibrations
Gain Calibration : calibrating...
Noise Calibration: not active
Sky Tipping : FAILED

Measurement
Time Reference: UTC
Date : 01|05|2006 Time: 15|41|40
File Backup : ACTIVATED
Repetition : 1
Duration : UNLIMITED
Start Time: 14|10|22 , 01|05|2006
Stop Time: UNKNOWN
Filename : 06050115

Controllers
Main Contr. : responding
Elev. Stepper: responding

Infrared Radiometer
IRR-Status : responding
Temperature : 8.3 °C

Disk on Module (DOM) Capacity:
Capacity [kBytes]: 248256

Other Sensors
Barometric Pressure: 988 mbar
Relative Humidity : 60 %
X-Inclinometer (Elev.): 0.0°
Y-Inclinometer : 0.0°
Rain Flag : RAINING

Elevation Scanner
Elevation angle: -90.0°
Azimuth angle : 0.0°
Bound. Lay.-Scan : ACTIVE

- **Disk on Module (DOM) Capacity**: The radiometer PC is equipped with a flash memory hard disk (no movable parts) called DOM. Its capacity – when empty - is 250 Mbytes. The status indicates, how much memory (measured in kBytes) is left for the backup of measurement files. If the remaining free memory is less than 20 Mbytes the backup files should be flushed (see section 5.4). When 10 Mbytes are reached no further file backup is performed.
- **Infrared Radiometer**: If the optional infrared radiometer is installed the infrared temperature is displayed here. This data can also be used as input for retrievals. In combination with the temperature profiles the cloud base height can be determined. The IR temperature provides a cloud flag (at least for non cirrus clouds).
- **Temperatures**: Four temperature sensors are implemented:



- The environmental temperature sensor is located outside of the radiometer box below the dew blower. The sensor data is an important parameter for the absolute calibration cold target temperature measurement.
- The ambient temperature target sensor precisely measures the built-in calibration target temperature. The precision of that sensor is essential for ALL calibration procedures.
- Receiver1 / Receiver 2: These temperature sensors reflect the physical temperatures of the receiver modules which are stabilized to an accuracy of < 0.03 K. Typical sensor readings are around 40°C. The thermal receiver stabilisation is continuously monitored. If the receiver temperature is kept constant to within +/- 0.03 K the status indicator on the right of the temperature display is green. If it turns to red the stability is worse than this threshold. In addition the actual stabilisation values are listed. The colour of the stability status indicator turns to yellow if not enough temperature samples have been acquired to determine the stability.
- **Other Sensors:** Five additional sensors are monitored:
 - Barometric Pressure: The pressure sensor measures the barometric pressure in mbar (accuracy ±1.0 mbar). The data is used in the determination of the precise boiling temperature of the liquid nitrogen coolant used in the external calibration target during absolute calibration.
 - Relative Humidity: The sensor is located below the dew blower system outside of the radiometer box. The data is used to control the dew blower fan speed when reaching a software predefined threshold. Its accuracy is ±5%.
 - Rain Flag: Status of the rain sensor. The flag is used to operate the automatic shutter system and is monitored with all measurements to distinguish between rain events and no rain.
- **Calibrations:** Here the status of automatic calibrations (gain calibration, noise calibration and sky tipping, see section 4) is monitored during measurements. All calibration data is automatically logged in the **CALLOG** file located in **MY DIRECTORY\RPG-HATPRO**. The contents of that file can be inspected with the  command (described later).
- **Elevation Scanner:** The data displayed here is the current position of the elevation scanner. The azimuth value only shows two positions, 0° and 180°. 0° means that the elevation scanner is currently moving in the quadrant marked by the orange arrow on the radiometer box. 180° indicates that the elevation scanner is moving in the other quadrant (only relevant for sky tipping bidirectional mode). Also displayed is the status of the boundary layer scan (see section 2.3).
- **Measurement:** During measurements this group box displays details like the file name of the current measurement, when the measurement was started and when it will end, the time reference (UTC or local time), if file backup is enabled on the radiometer PC and the batch repetition factor.

5.4 Data Storage Host Configuration

There are two different ways of data storage during measurements:

- Data files are stored on the radiometer PC by enabling the file backup option in the measurement definition file (MDF, explained later). The data transferred to the host for online display are not stored by the host PC. If the data files need to be inspected or further processed then they have to be transferred from the radiometer to the host



PC. This procedure can be quite time consuming due to the relatively low transfer speed via the RS-232 connection (9 kBytes / sec. max.). The only advantage of this storage mode is that once the measurement has started, the host can be disconnected from the radiometer (it is then replaced by a Host Replacing Connector) while the radiometer continues its operation.

- File backup on the radiometer PC is enabled or disabled and the data transferred to the host PC is stored by the host in a predefined data directory. This is the most common operation mode for long term measurements because data files are transferred online from the radiometer to the host. Of course the host computer has to be permanently connected to the radiometer PC. When the host is connected to a network it can regularly send the data files to an FTP server located far away from the measurement site. The file backup on the radiometer is only used as a safety option for the case that the host PC has a power failure or hard disk problem.

The *Host Configuration* group box on the main screen displays the data storage details. It is possible to change the settings by clicking  (*Define Directories*). The automatic host data storage during measurements can be enabled or disabled and the data storage directory is selected from the directory tree shown in *Data Directory*. In the same menu one can specify if an ASCII or netCDF version of the data files (which are in binary format by default) shall be generated. ASCII and / or netCDF files will then (if this option is selected) be stored to the same data directory as the binary files.

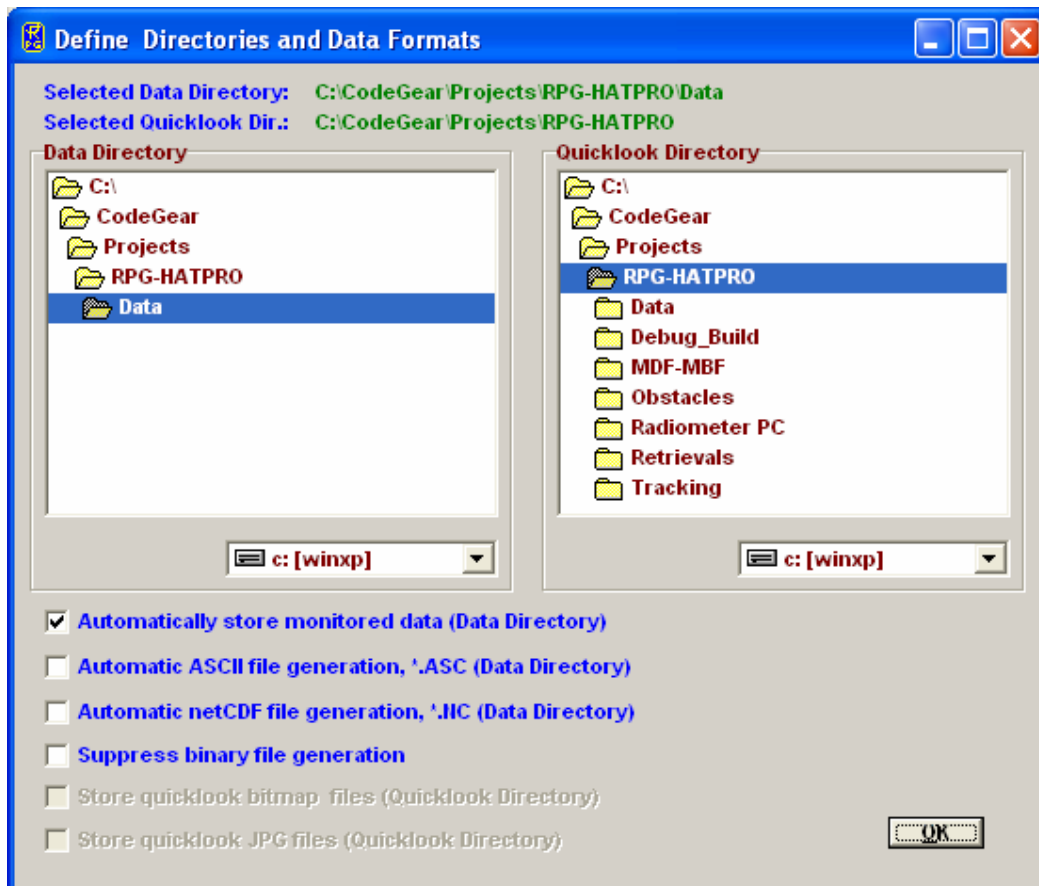

Define Directories Menu including data file directory and quicklook file directory selection.



Quicklooks are bitmaps or JPG files showing the contents of the binary data files in graphical form. A separate directory can be defined for quicklooks and the available file formats are bitmap or JPG. Quicklooks are useful when the radiometer data files are regularly transferred to an FTP server and the data shall be displayed automatically using script programming etc.

5.5 Exchanging Data Files

The radiometer PC's hard disk has three directories which are accessible from the host computer:

- Data Files Directory
- System Files Directory
- Root Directory

The data files directory is used to store all backup measurement files with unlimited access for READ and WRITE. The system files and root directories contain files that are essential for the radiometer operation. That is why the access for this directories is READ ONLY. Its files should not be manipulated or deleted by the user. If one tries to write to these directories, the host prompts for a password to be entered. Only the radiometer administrator should know this password for software updating (overwriting **2CH.EXE**). Overwriting **2CH.EXE** with a non-operating software or deleting this executable file will disable all radiometer functions and requires a system re-initialisation by RPG!

To get access to the radiometer directories click  (*Exchange Data and System Files with the Radiometer*). The menu in Fig.5.2 will be displayed.

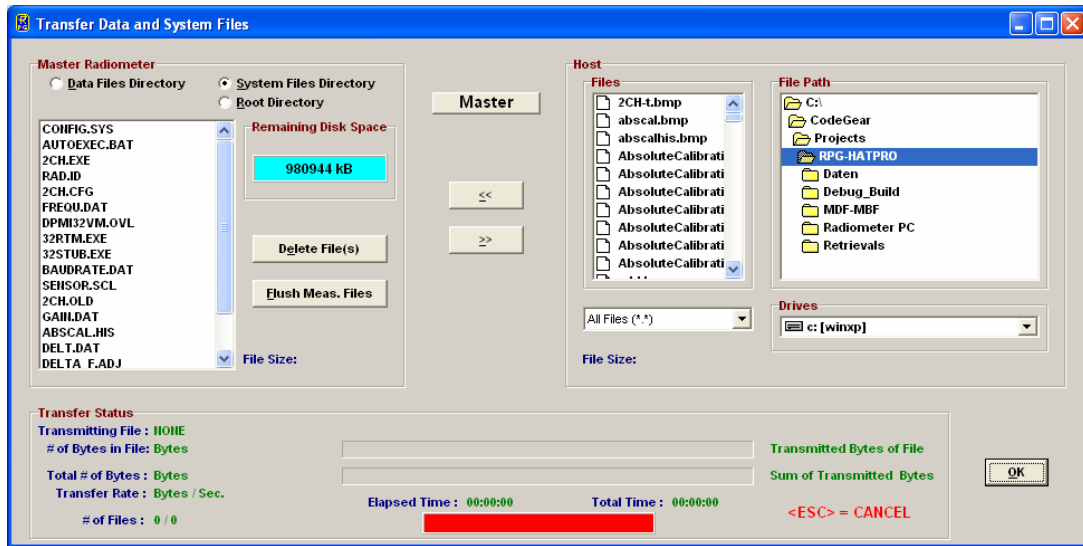

Fig.5.2: File transfer menu.

File transfer is necessary when backup data files need to be copied from the radiometer hard disk to the host computer. If file backup is enabled for a measurement, the instrument stores all data files in its **Data Files Directory**.

The **System Files Directory** contains the following files:

- **32RTM.EXE** runtime library



- **32STUB.EXE** stub file loaded by **2CH.EXE** to enter protected mode
- **DPMI32VM.OVL** overlay file for DOS protected mode interface
- **2CH.EXE** radiometer software
- **FREQU.DAT** contains frequency list of radiometer
- **RAD.ID** contains radiometer ID (RPG-HATPRO, etc.)
- **SENSOR.SCL** sensor calibration file
- **ABSCAL.CLB** absolute calibration parameters
- **ABSCAL.HIS** absolute calibration history file

2CH.EXE is the executable that boots up when the radiometer is turned on. The program handles all automatic tasks like detector readout, calibrations, elevation scanning, file storage etc. The only reason for writing to the system file directory is the installation of a **2CH.EXE** software update. Write operations to the system files directory are password protected and are reserved for authorized personnel only (contact RPG for password information).

Reading from the system files directory is required when the absolute calibration history file shall be inspected. The file **ABSCAL.HIS** stores all absolute calibrations (including successful tip curve calibrations). Once copied to any directory on the host hard disk its

contents can be browsed by the  command (see section 5.6).

Toggling between data files directory and system files directory display is achieved by pressing the **Data Files Directory** or **System Files Directory** radio buttons in the **Radiometer** group box.

By double clicking on one of the files in the list, the file size in Bytes is displayed. In order to delete the backup files from the data files directory press **Flush Meas. Files**. This will delete all backup files from the radiometer. It is not possible to delete single backup files because they are packed together in bigger files to reduce the total number of files on the flash drive. DOMs have problems in handling large numbers of files. During a 3 month continuous operation up to 20.000 data files are generated by the RPG-HATPRO radiometer which would overload the DOM file system capabilities if they were stored as single files. Packing these files is the only way to handle the problem. Before flushing the backup files they should all be copied to the host first (if the data was not monitored on the host PC with automatic data storage). By pressing **Delete Files** only single files are removed from the system files directory (password entry required).

When a file needs to be copied from the host to the radiometer, first browse through the host directory tree and mark the file in the file list. Then select **Data Files Directory** or **System Files Directory** and press <<. The copy progress is displayed in the **Transfer Status** group box. Copying in the other direction (from radiometer to host) is done with the >> command.

Multiple files may be selected for deleting and file transfer in both directions. If a file transfer in progress is aborted, the user may terminate the operation by pressing <ESC>.

5.6 Inspecting Absolute Calibration History

As mentioned in section 5.4 the **ABSCAL.HIS** file located in the system file directory on the radiometer PC stores all absolute calibration results. This also includes the successful tip curve calibration of the water vapour line channels. In order to inspect this calibration history,

first copy **ABSCAL.HIS** from the radiometer to the host. Then press  (**Open Data Files**)

and select  to invoke the **Absolute Calibration History** menu. Load the previously copied **ABSCAL.HIS** file with **Load History File** and the list of calibrations is displayed (see Fig.5.3).



The listed entries are incrementally numbered (preceded by #). The entry syntax is:

#calibration number: Hum. Profiler cal. type / Temp. Profiler cal. type, (date and time of Hum. Profiler calibration || date and time of Temp. Profiler calibration)

When an entry in the list is marked, *Delete Last Entries* removes all entries after the marked entry. This feature is useful to remove 'bad' calibrations from the list (typically the last calibration). With *Generate* a new calibration file *ABSCAL.CLB* is generated using the calibration numbers specified for receiver 1 and 2. If the modified *ABSCAL.CLB* file is copied to the system files directory (password protected) the radiometer will load the new calibration parameters from *ABSCAL.CLB* when *2CH.EXE* boots up the next time.

Double clicking on one of the entries opens the *Calibration Results* menu in Fig.5.4. For each receiver channel the four parameters G, α, T_{sys} and T_n (see section 4.1.3) are listed. In addition the calibration type, calibration time and physical temperature of calibration targets and the environmental temperature are stated.



Fig.5.3: Loading the calibration log file *ABSCAL.HIS* into the calibration history list.

5.7 Inspecting Automatic Calibration Results

Automatic calibrations are those described in section 4.3, 4.4 and 4.5 (Gain, Noise, Tip Curve). These calibrations are performed automatically by the radiometer following the calibration settings in the measurement definition file (see section 5.8). Monitoring of automatic calibrations is carried out by the (enabled) *Radiometer Status* window on the main



screen. The corresponding log file is **CALLOG** located in **MY_DIRECTORY\RPG-HATPRO**.

For inspecting this log file press (**Display Automatic Calibration History**). The menu in Fig.5.5 appears. In the **Gain Calibrations** group box only gain parameters are displayed (the only parameter that is adjusted by this calibration type, see section 4.4) while also T_{sys} (**Tsys**) and T_n (**Tnoise**) are selectable in **Noise Calibrations** and **Sky Tipping Calibrations**. The user may zoom into the data by clicking on the graphics display (holding the left mouse button pressed) and dragging the mouse cursor to a second position. When the mouse button is released the new data window appears. **Zoom Out** reverts to the previous zoom. The precise moment of each calibration is indicated by a dot (• and – toggle this feature). All diagrams are synchronized if **Synchronize Diagrams** is active. Then zooming and zooming out is performed on all displays so that a common time axis is maintained. **Independent Diagrams** switches back to the non-synchronized display mode.

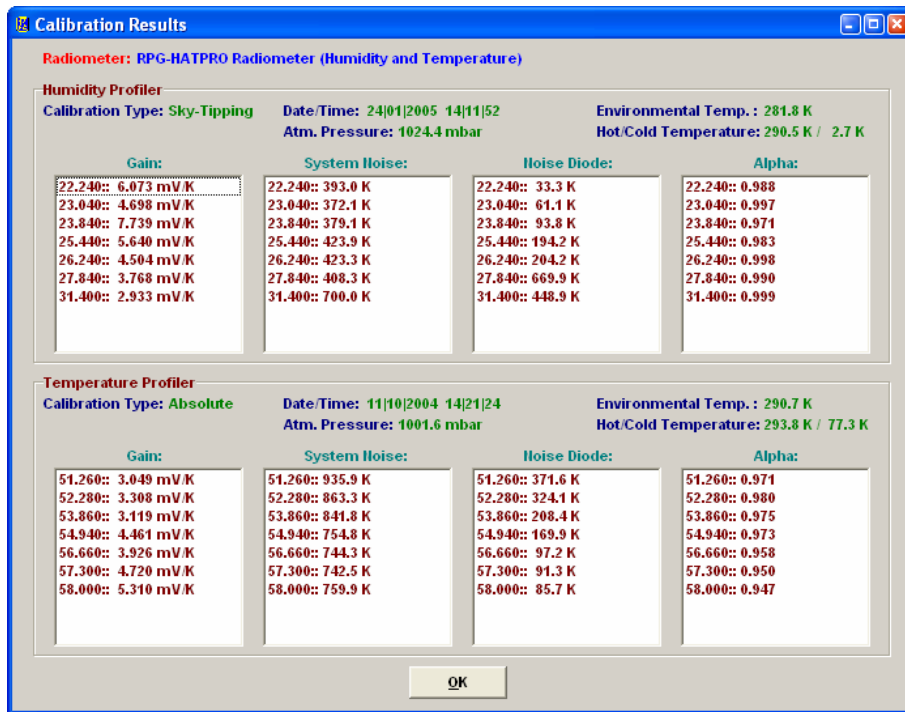

Fig.5.4: Display of absolute calibration parameters.

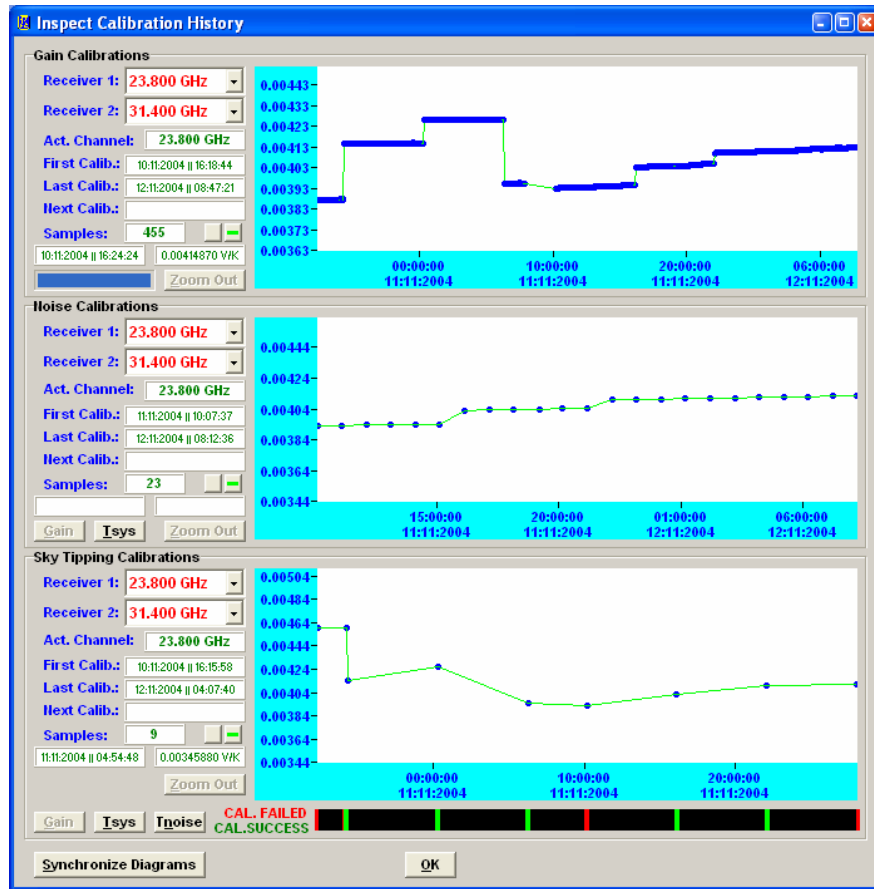

Fig.5.5: Display of automatic calibration parameters.

Below the *Sky Tipping Calibrations* data display the successful calibrations are marked by a green bar while failed calibrations are marked in red. By clicking on one of these bars the tip curve calibration details are listed and a graphical display of the sky dip is shown.

5.8 Absolute Calibration

After setting up the external cold target as described in chapter 4.1.2, an absolute calibration is initiated by pressing (*Perform Absolute Calibration*). The menu in Fig.5.6 is shown.

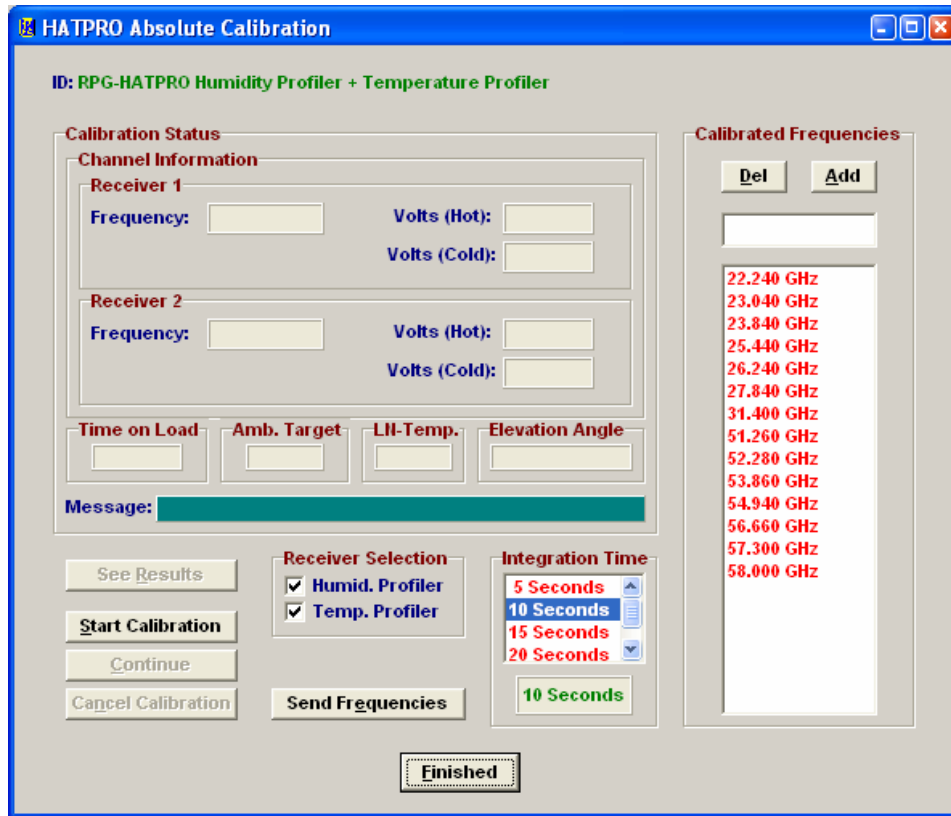

Fig.5.6: Absolute calibration menu.

When the absolute calibration menu is entered the frequency list is loaded from the connected radiometer and displayed in *Calibrated Frequencies*. The list contains the frequencies of both receivers that will be calibrated assuming the related receivers are checked (*Humid. Profiler*, *Temp. Profiler*) in *Receiver Selection*. The integration time T_i is selectable between *5 Seconds* and *60 Seconds* (*Integration Time* group box) and defines the integration time period for each calibrated channel. The total integration time is given by $T_{total} = 4 * T_i + 10$ because four integration cycles have to be passed according to section 4.1.3.1 (four point method) and calibration mirror movements take about 10 seconds.

Start Calibration starts the absolute calibration procedure. During calibration the current activity is displayed in the message line. When the integration cycles have completed, the message *Calibration successful! Save?* is displayed and the user has to confirm to save the calibration with *Continue*. The absolute calibration parameters are then stored on the radiometer PC. Leave the calibration menu by pressing *Finished*.

If the error message *No response to cold load. Calibration terminated!* appears, the cold target was probably not filled with liquid nitrogen or was not installed at all.

No noise diode response. Calibration terminated! indicates a malfunction of one of the noise sources. Contact RPG for help in this case.

The calibration menu for the RPG-15-90 radiometer shows an additional box (*Ambient Target*) for the ambient temp. target. This radiometer is calibrated by external hot / cold targets and does not use an internal ambient target. Therefore *Automatic* should be unchecked and the temperature of the external ambient target is measured manually by a thermometer. The thermometer temperature reading (in °C) is entered to the **Temp.:** editor box before the calibration is started. The user has to change the hot and cold targets manually. The software is prompting for these actions.



5.9 Defining Measurements

Before a measurement can be started, it has to be defined. The various measurement parameters are then stored in a MDF (Measurement Definition File, extension *.MDF*). The radiometer is capable of processing multiple MDFs automatically which are combined in a MBF (Measurement Batch File, extension *.MBF*). The MBF is a batch file similar to DOS batch files but only intended to group MDFs. Only MBFs can be sent to the radiometer, not MDFs, even if just a single MDF shall be sent. It has to be encapsulated in a MBF file first!

To enter the *Definition of Measurement and Calibration Parameters* menu press  (*Define Measurement Parameter Files (MDF and MBF)*).

The measurement definition menu has several tab sheets (*Sky Tipping*, *Standard Calibrations*, *Products + Integration*, *Elevation Scanning*, *Timing + ...*, *MDF + MBF Storage*) which should be processed from left to right (see Fig.5.7).

5.9.1 Sky Tipping

The sky tipping (or tip curve) calibration is described in detail in section 4.5. Fig.5.7 shows the corresponding definition tab sheet.

The scanning angles listed in the *Elev. Scan Angles [DEG]* group box are predefined to give equidistant air mass samples in the sky tipping scan (the air mass is proportional to $1 / \sin(\alpha)$, see section 4.5). They can be modified by *Add* and *Delete* but it is recommended to only define angles $>20^\circ$. If the radiometer's horizontal view is blocked by obstacles the lowest elevation angle should be adjusted appropriately but should not be $>30^\circ$ to maintain the calibration accuracy. The calibration reliability may be improved by checking *Bilateral Tipping (Handling)* group box). With bilateral tipping the radiometer scans the elevation angles in both quadrants (0° and 180° azimuth angle) to detect possible inhomogeneous water vapour distributions which might violate the requirements for a stratified atmosphere. This of course assumes a free view to both observation sides between 20° and 90° elevation.

Sky Tipping is enabled by checking *Enable Sky Tipping*. The user can specify how often a calibration shall be performed by selecting a period between *10 Minutes* and *24 Hours*. Practical periods are 2 to 24 hours because the radiometer gain is normally calibrated every 5-10 minutes by a gain calibration and a full parameter recalibration (including T_{sys} and T_n) is not required so frequently. In addition a tip curve interrupts the measurement for more than three minutes which should be kept to a minimum.

Furthermore it is possible to define the time of the first tip curve calibration in the measurement. By checking *period absol. (0:0:0)* the calibration will start relative to midnight time, e.g. with a period of 6 hours and a measurement start at 3:00 pm the first calibration will take place at 18:00 assuming that *first cal. @ mea. start* is not checked. If *rel. to measure. start* is checked the calibration timing is relative to measurement start time.

As explained in section 4.5, tip curve calibrations are only applicable for humidity profiler channels. That is why the *Temp. Profiler* checkbox is disabled.

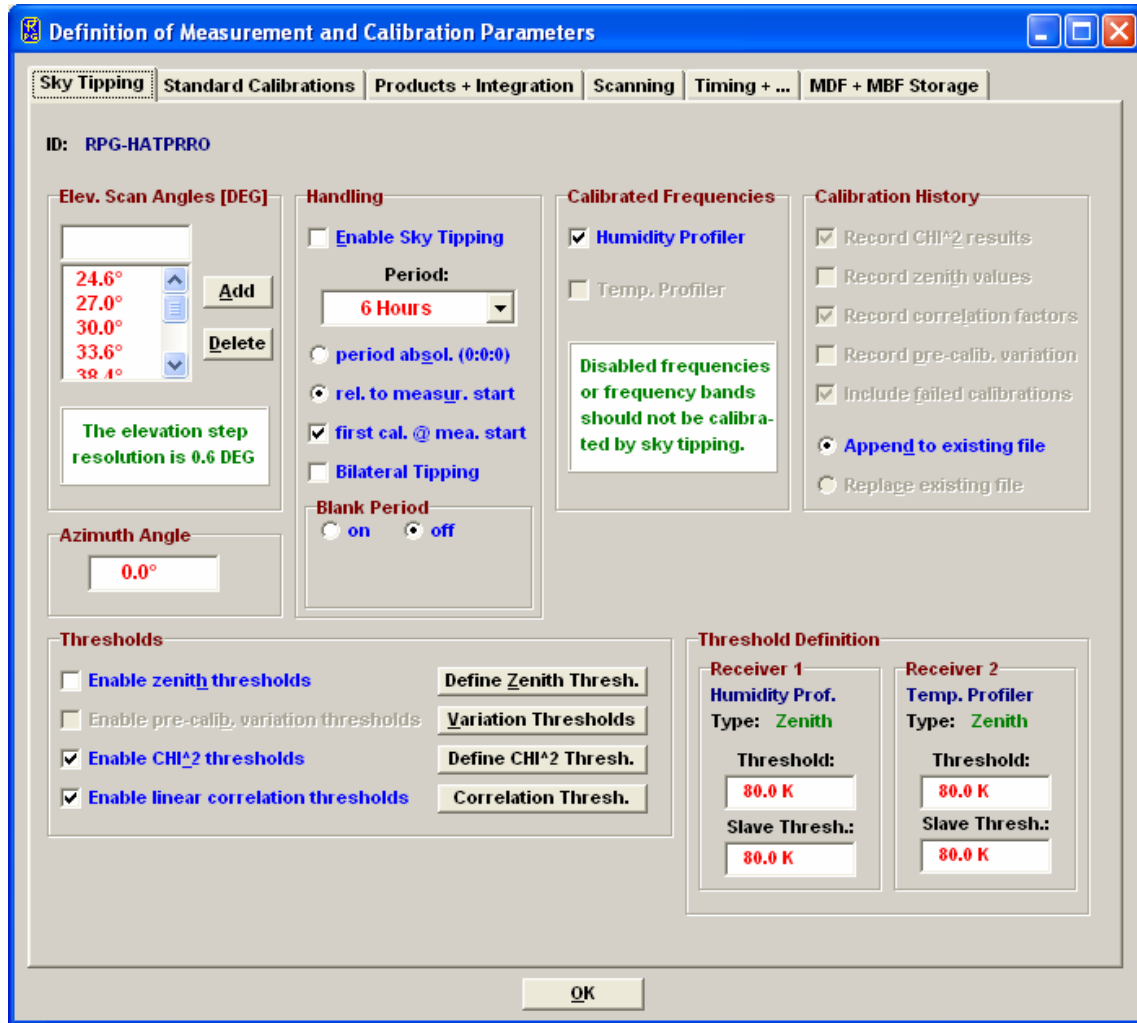

Fig.5.7: Measurement definition file menu, sky tipping tab sheet.

So far three quality checks (thresholds) are implemented which can be individually enabled or disabled:

- Zenith threshold. In the presence of clouds (which violate the assumption of a stratified atmosphere) the observed zenith brightness temperatures (BTs) are significantly higher than under clear sky conditions. The user can define maximum BTs as a threshold for each channel to reject the calibration.
- Linear correlation factor. This measures the correlation of the optical thickness samples (as a function of air mass) with a straight line. Typical linear correlation factor thresholds are >0.995 . The linear correlation factor is not sensitive for the noise of the optical thickness samples caused by clouds etc.
- χ^2 -test. This measures the variance of the optical thickness samples relative to the straight line. Typical threshold values are <0.4 for a good quality calibration.

With *Define Zenith Thresh.*, *Define CHI² Thresh.* and *Correlation Thresh.* the corresponding thresholds can be entered in the *Threshold Definition* group box.



5.9.2 Defining Automatic Standard Calibrations

This tab sheet is not applicable for the ATPROP receivers because they have full auto-calibration front ends.

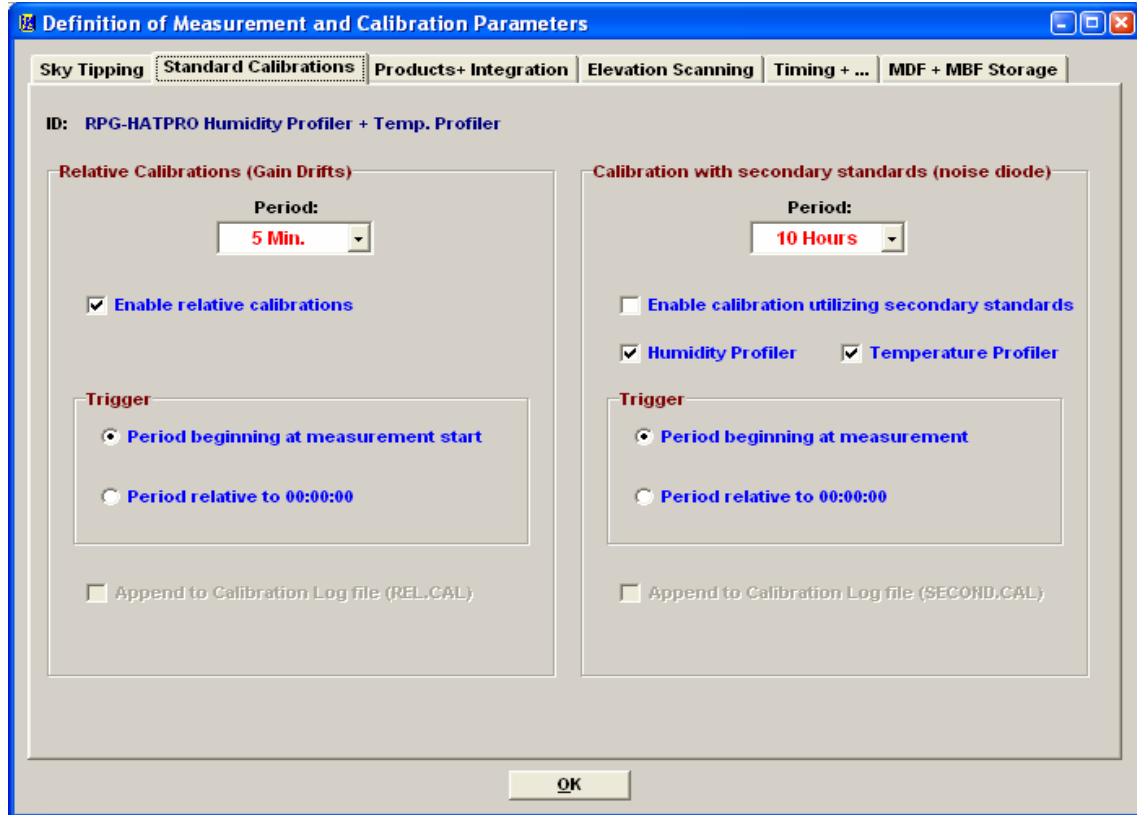

5.9.3 Products + Integration

On the *Products + Integration* sheet (see Fig.5.8) the user selects the products he wants to be acquired and calculated by the system. Only those products are enabled in the product list, which are compatible with the actual radiometer configuration.

For those products with associated retrieval files, the user can select one of the retrievals listed in the related list box. The entries of these boxes reflect the data base that is currently available or applicable, e.g. LWP retrievals exist in three versions: one for two channels (for 23.8 and 31.4 GHz, RPG-LWP radiometers), one for three channels (23.8, 31.4 and 90 GHz, RPG-LWP-U90 radiometers) and one using 7 water vapour line channels (22.24, 23.04, 23.84, 25.44, 26.24, 27.83 and 31.40 GHz, RPG-HATPRO / HUMPRO radiometers). When the user of a RPG-LWP radiometer defines a MDF, the only retrievals that will be listed in the LWP retrieval list box are those for two channels. If he upgrades to a RPG-LWP-U90, the three channel retrievals are also listed.

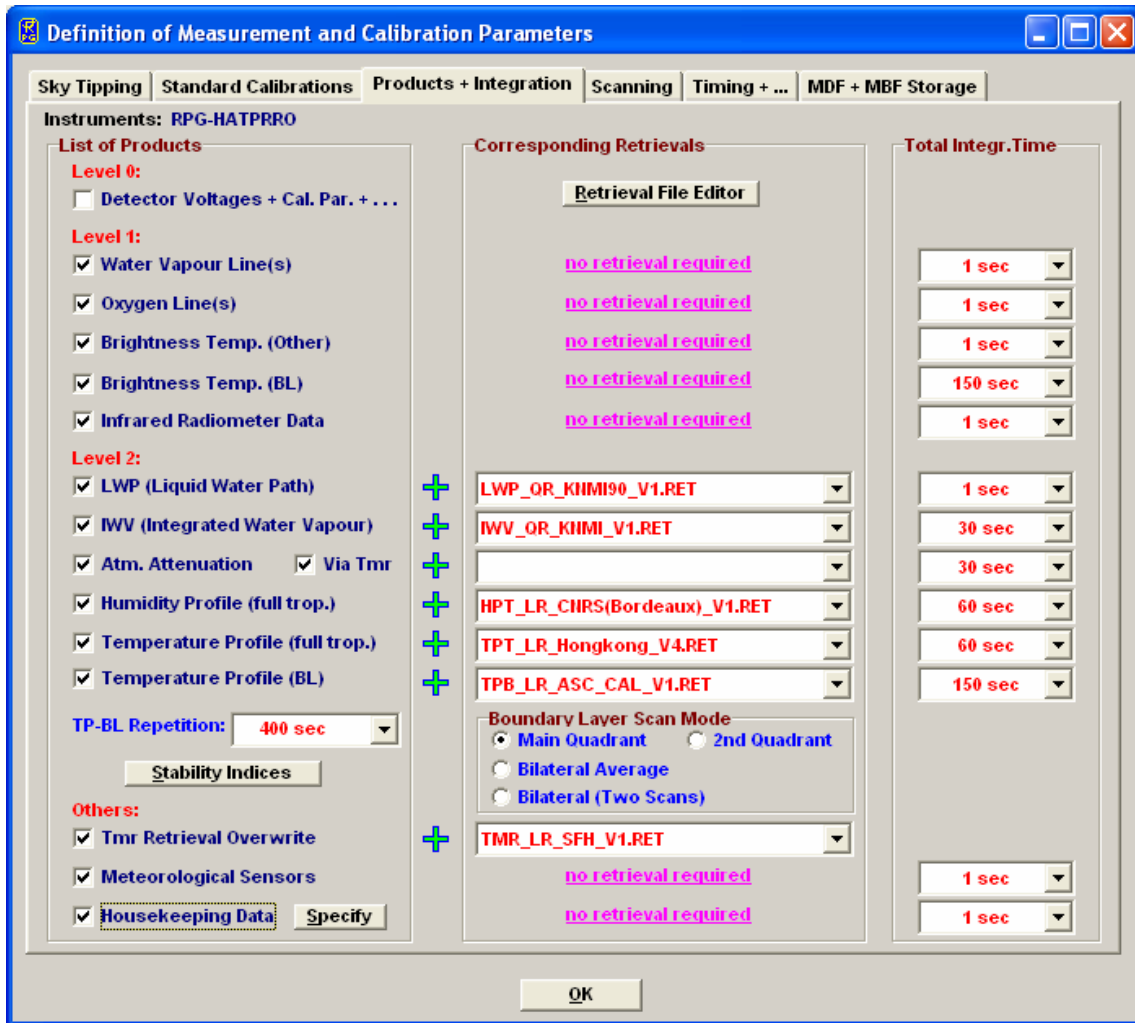

Fig.5.8: Specifying the retrievals and other products available for the radiometer configuration.

Right clicking on one of the retrieval file entries opens a text window displaying the retrieval file contents. A description of retrieval files and how to create them will be given later.

Modifications of these files should be restricted to qualified personal only. Otherwise the modified retrieval algorithm may not work properly.

For each enabled product a separate integration time is selectable, but there is an exception: It is not possible to define a different integration time for the *Brightness Temp. (boundary layer)* and *Temperature Profile (boundary layer)* products because these products are closely related to each other. In fact the temperature profile is just a further processed product derived from the brightness temperatures of the boundary layer scan. The user may define a customized T_{mr} retrieval and overwrite the default radiometer T_{mr} retrieval. If specified and checked, the new retrieval is used for sky tipping calibrations. For explanations on T_{mr} see section 4.5.

Boundary layer scans can be combined with full troposphere temperature profiling in a single measurement. If only boundary layer scans shall be carried out, select the *CONTINUOUS* entry in the TP-BL Repetition list box; only boundary layer profiling data, meteorological sensor data and infrared radiometer data (if installed) will then be produced. All other selections in the TP-BL Repetition list box define a repetition period for boundary scans. After a BL scan has finished, the other products like LWP, full troposphere temperature



profiles etc. are generated, and remain until the next BL period is initiated. Example: Define a TP-BL repetition period of 600 seconds and an integration time of 200 seconds for the **Temperature Profile (boundary layer)** product. At measurement start, a BL scan is carried out which takes about 200 seconds. The next scan will start 400 seconds later. In the meantime the other selected products are processed.

The boundary layer scan can be performed in four different modes, selectable from the **Boundary Layer Scan Mode** box. The radiometer is usually scanning in the main quadrant (marked by a red arrow) but it is possible to switch to the opposite quadrant (called 2nd quadrant). Two scans in both quadrants can be averaged and combined into a single BLB scan (Bilateral average). But the two scans in the different quadrants can also be stored independently (Bilateral, two scans).

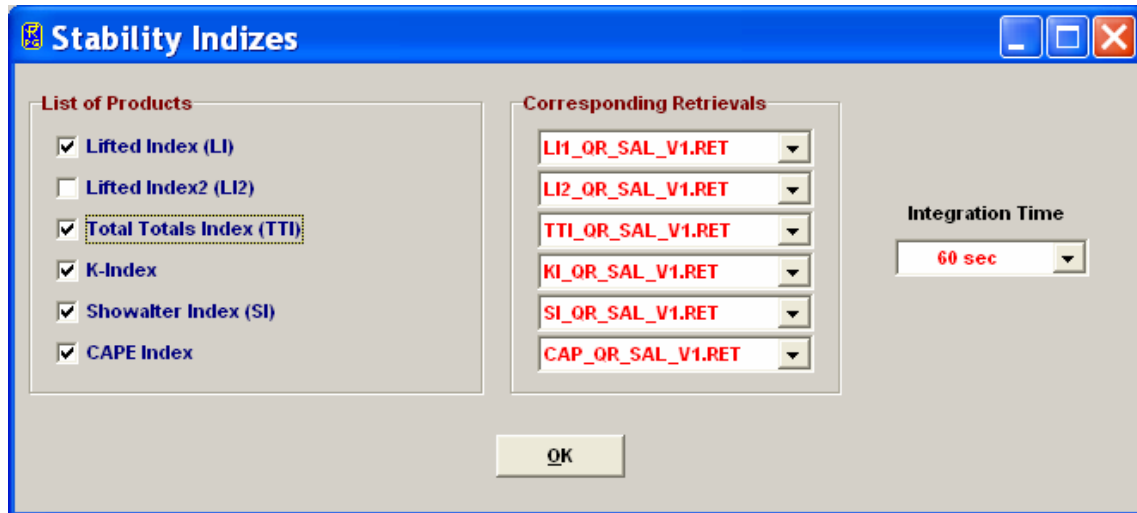
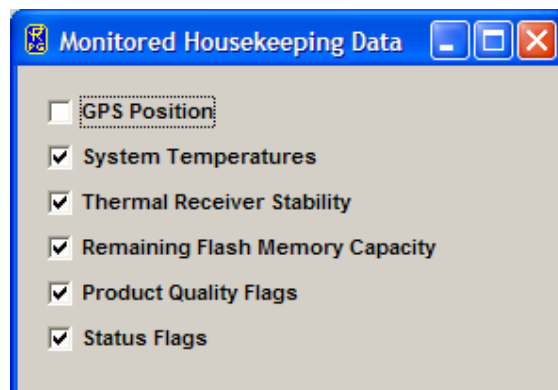

Fig.5.8b: Product list of stability indices with associated retrievals and integration time.

If the **Oxygen Line Profile** and **Water Vapour Line Profile** products are both selected the **Stability Indices** button is enabled. By clicking on it the menu in Fig.5.8b is shown. It displays a list of the most common stability indices used for characterisation of weather situations like tendency for thunderstorms etc. Each of these indices has its own retrieval stored in **MY_DIRECTORY\RPG-HATPRO\RETRIEVALS\MISCELLANEOUS**. All of these retrievals are using the full set of frequencies of the RPG-HATPRO; this is why both line profile products must be selected to acquire all brightness temperatures.

The **Housekeeping Data** product represents a summary of different parameters characterizing the instrumental state. These parameters are grouped into 6 categories. The monitoring of each category can be selected by clicking the **Specify** button. The following menu pops up:





The detailed description of each category is given in appendix A18.

5.9.4.1 Scanning

Sometimes it is desirable to scan the elevation / azimuth angle while taking measurement samples. The details for this scanning are defined in the *Scanning* tab sheet. When scanning is disabled a constant elevation angle is used for observations. IWV and LWP retrieval products can be selected in combination with scanning when multi-angular retrievals are provided.

Thus only IWV, LWP and brightness temperature data products may be combined with scanning. The elevation mirror moves are subdivided into elementary scans from a start angle to a stop angle with a certain incremental angle and a given number of samples measured at each position. These scans are numbered as Scan#1, Scan#2,....

The radiometer does not execute single scans but only frames of scans. Each frame has a start scan and a stop scan (can be identical) which form a 'loop' of scans that can be repeated arbitrarily. The concept of having two levels of movement definitions allows for designing complex scan procedures. The elevation mirror speed is always constant.

A frame is defined by clicking on one of the scans in the start scan list and then clicking on one in the stop scan list. After entering the repetition number, the frame is added (or inserted) to the frame list (*Add* or *Insert*). In addition the frame start can be triggered to a certain time increment (e.g. 5 minutes). Three examples illustrate how a frame is executed:

- 1) Start: Scan#4, stop: Scan#6, repetitions: 3 ⇒
Scan#4,Scan#5,Scan#6,Scan#4,Scan#5,Scan#6,Scan#4,Scan#5,Scan#6
- 2) Start: Scan#4, stop: Scan#2, repetitions: 2 ⇒
Scan#4,Scan#3,Scan#2,Scan#4,Scan#3,Scan#2
- 3) Start: Scan#2, stop: Scan#2, repetitions: 1 ⇒
Scan#2

When an optional azimuth positioner (see section 8.2) is installed, a full 2D sky scan can be programmed by checking the *2D Scan* check box. The radiometer then uses the given start and stop angles for elevation and azimuth as edge angles and performs a 2D scan within these limits. E.g. a full sky scan is defined by setting the elevation start angle to 0.0°, the elevation stop angle to 180.0° (a 9° increment angle produces elevation 21 steps at const. azimuth angle), the azimuth start angle to 0.0° and the azimuth stop angle to 170.0° (step increment 10°). This generates a measurement of 378 scan points with an angular resolution of 10°. The radiometer selects an integration time of only 0.4 seconds / sample to reduce the time needed for a full scan to a minimum. The 'Samples / Pos.:' entry is ignored in this mode. The full scan in this example takes only about 5 minutes! High speed scanning is feasible due to the parallel architecture of the RPG radiometer's direct detection filterbank receivers described in section 3.2.

In the example above the 90° elevation angle would be scanned 18 times if the *Multiple 90° Samples* check box is checked. This leads to redundant zenith information that can be used to derive a time series of other products during full sky scanning. But it increases the time for a full scan due to redundant samples. If the user wants to optimize the scanning time he can uncheck the *Multiple 90° Samples* check box. In this case the zenith scanning angle is only encountered once during a full sky scan.

When products with different integration times are selected for scanning, *2CH.EXE* adjusts all integration times to the maximum integration time of the products list.

Example:

A RPG-HATPRO radiometer is setup for scanning with the water vapour line brightness temperature product (integration time: 10 sec.) and the oxygen line product (integration time:



30 sec.) selected. Then the integration time during the scan will be 30 seconds (also for the water vapour line channels).

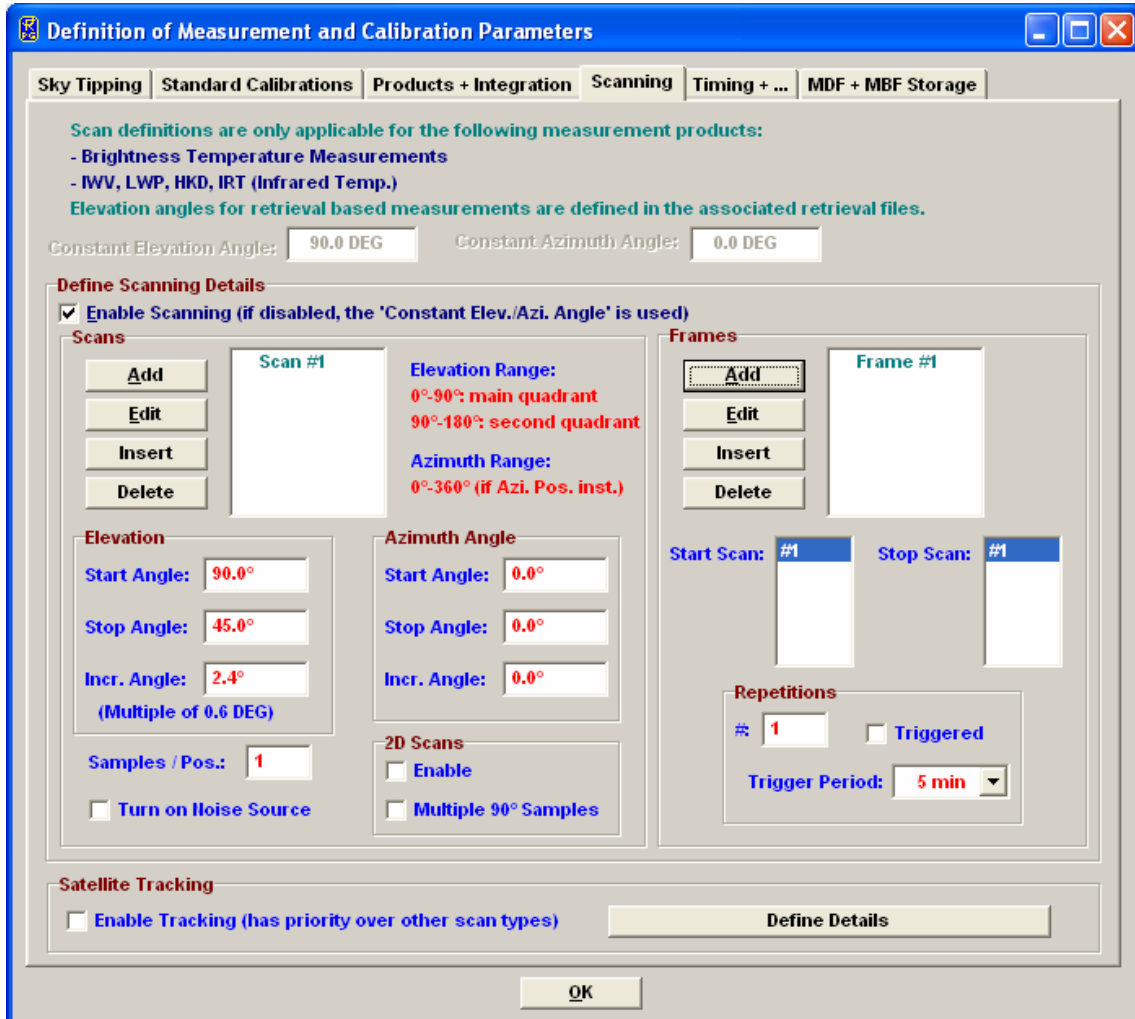

After the definition of the start angle, stop angle and increment angle, the settings are stored as a scan by clicking **Add**. Every scan in the scan list can be marked and overwritten with the current settings by using the **Edit** command. When clicking on a scan number in the scan list, the actual settings of that scan are displayed.

5.9.4.2 Satellite Tracking

When the radiometer system is equipped with an azimuth positioner, so that full sky scanning is possible, the instrument can run in satellite tracking mode by checking the **Enable Tracking** check box. This feature – if selected - has priority over all other scanning modes. In satellite tracking mode, the radiometer periodically scans a number of visible GPS or Galileo satellites and measures the wet delay component, LWP and attenuation in the line of sight to each of the satellites. The user should activate these products (IWV, LWP, Attenuation) in the MDF product list with identical integration time (typically one second). The system determines the satellite positions from a RINEX navigation file stored in the **TRACKING** subdirectory (see section 5.1.2) and its own GPS position. The azimuth positioner's 0.0° azimuth angle has to point to North direction (90° = West, 180° = South,



270° = East) to guarantee correct scanning positions. In *Define Details* the user can specify the tracking details:

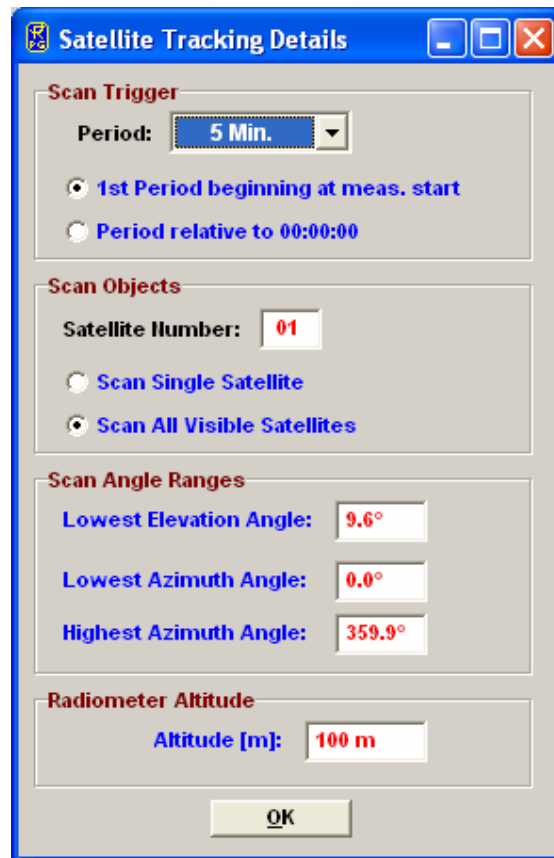

The period determines, in which time intervals the scan shall be repeated. In ‘Scan Objects’ one can specify, if all visible satellites shall be scanned or just a single satellite. In the later case, the user must enter the satellites number. The angular scan range should be limited (e.g. in elevation) if not all sky directions are available due to obstacles.

RINEX navigation files can be loaded from the European IGS FTP data server <ftp://igs.ensg.ign.fr/pub/igs/data/> and usually have the extension ‘.YYn’ where YY stands for the year, e.g. ‘.08n’ is a navigation file from 2008. E.g. the file <ftp://igs.ensg.ign.fr/pub/igs/data/2008/225/dlft2250.08n> is from Delft (dlft), day of the year 225 (12. August). The RINEX navigation files are ASCII formatted files and contain the orbit information for all satellites of a certain navigation system like GPS or Galileo. The host software periodically (every hour) checks if there is an updated RINEX file in the **TRACKING** subdirectory and automatically loads it if available. The software calculates the current positions from the information given in the RINEX files and the actual UTC time and the radiometer position on earth.

Tracking data files are stored in ASCII format with extension ‘*.TRK’.

5.9.5 Timing +...

Start time, end time and time reference are important parameters for a measurement setup. The time reference can be set to UTC or local time which is UTC + time shift [h]. The radiometer determines UTC from a GPS clock reading which is updated every 10 minutes.



There are two ways of triggering a measurement: Immediately after launching the measurement batch or at a certain time and date. Using a start time before the current time is equivalent to an immediate start. If the measurement start is triggered to a certain time, the check boxes *Ignore Date* and *Ignore Hour* allow for a date or hour independent triggering. This is particularly useful in a repeated multiple MDF batch measurement, where MDFs are repeated multiple times. A triggering to a certain date / time would trigger the MDF only once but not repeatedly. E.g. if the is *Ignore Hour* checked ('Triggered' mode activated) and the 'Start Time' entry is set to 22|36|15, the measurement is triggered to 00:15:00, 01:15:00, 02:15:00, ..., ignoring the current date and hour.

Two options are available for measurement termination. In LIMITED mode the user can set a duration or termination time. If the stop time is before the start time, the measurement duration is adjusted to 100 seconds.

In the case that the measurement has a well-defined end time (automatic measurement termination, LIMITED mode) the radiometer needs a filename for storing backups. The user may enter any filename not longer than 8 characters. The host also uses this filename when it is operated in automatic storage mode. If measurement timing is set to UNLIMITED mode the radiometer automatically generates filenames deduced from the actual time and date and ignores the measurement filename entry.

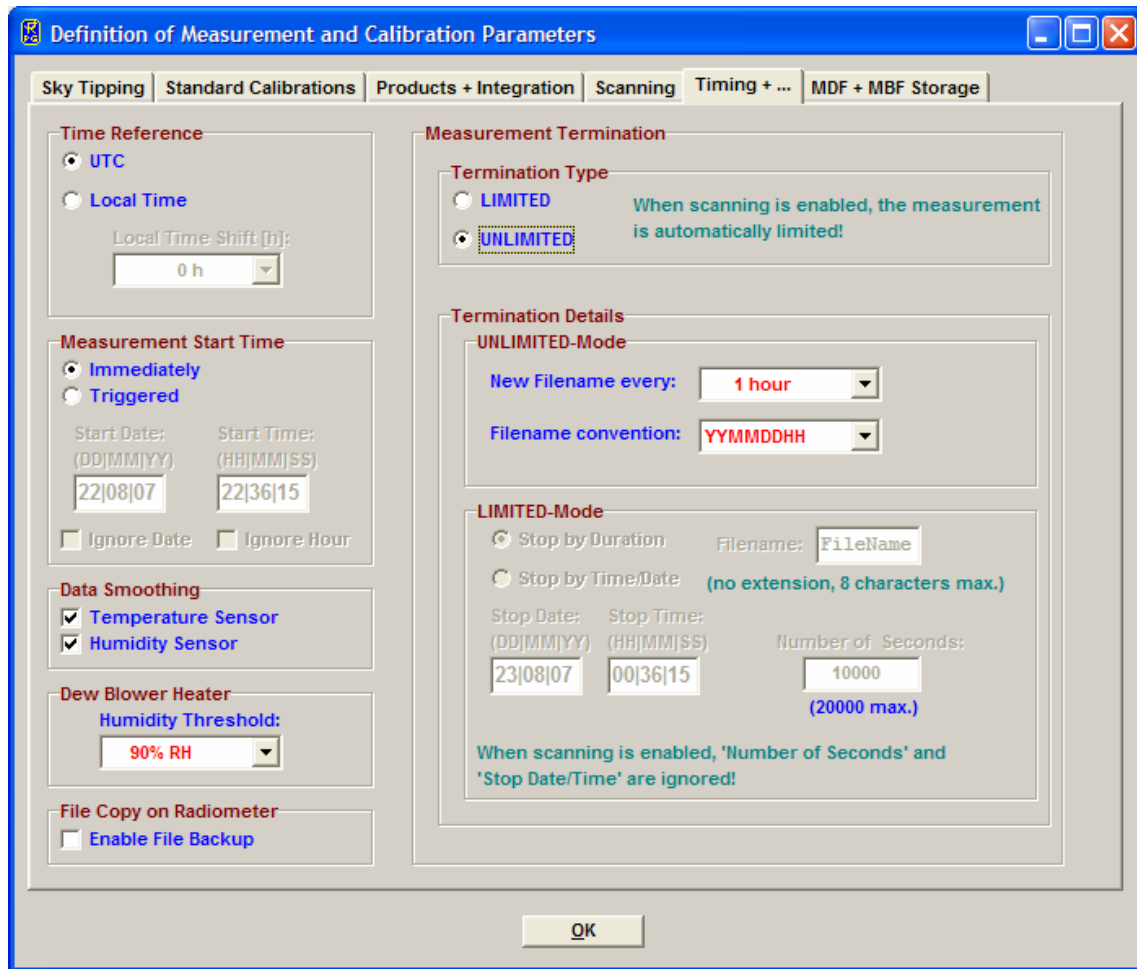

Fig.5.9: Timing+... definition menu.



In UNLIMITED mode the user must terminate the measurement manually. A new filename is generated every X hours where X is selected from the 'New Filename every' list box. The file format is one of 14 possible versions given in the 'Filename convention' list box. In the format string HH=hours, DD=days, MM=month and YY=year of the actual time and date. During measurement this filename is also transmitted to the host, which uses it for file storage of monitored data (assuming that the host is operated in "Automatic Storage" mode).

Since the temperature and humidity environmental sensors respond quickly to changes of the corresponding parameters (caused by turbulence in the vicinity of the radiometer) it is sometimes desirable to smooth the data samples of temperature and relative humidity. This is important if retrievals are utilizing the meteorological sensors, but the detailed surface turbulence at the radiometer location are not of interest and thus only lead to noisy retrieval results if not filtered. In *Data Smoothing* one can activate a 10 minutes LIFO filter to smooth the environmental temperature and humidity readings.

A humidity threshold can be defined for setting the dew blower fan speed to full power.

Another feature of the *Timing+...* tab sheet is the enabling of a file backup on the embedded PC. When backup is enabled, the checked products will be automatically stored in the radiometer's data directory. This is usually done for safety reasons because the standard mode of measurements is to enable automatic data storage on the host (online monitored data). With this method the data transfer virtually does not require any time. Without monitoring the data on the host and only storing it on the radiometer as backup the user will sooner or later have to transfer the data from the embedded PC to the host using the *Transfer Data and System Files* menu.

5.9.6 MDF + MBF Storage

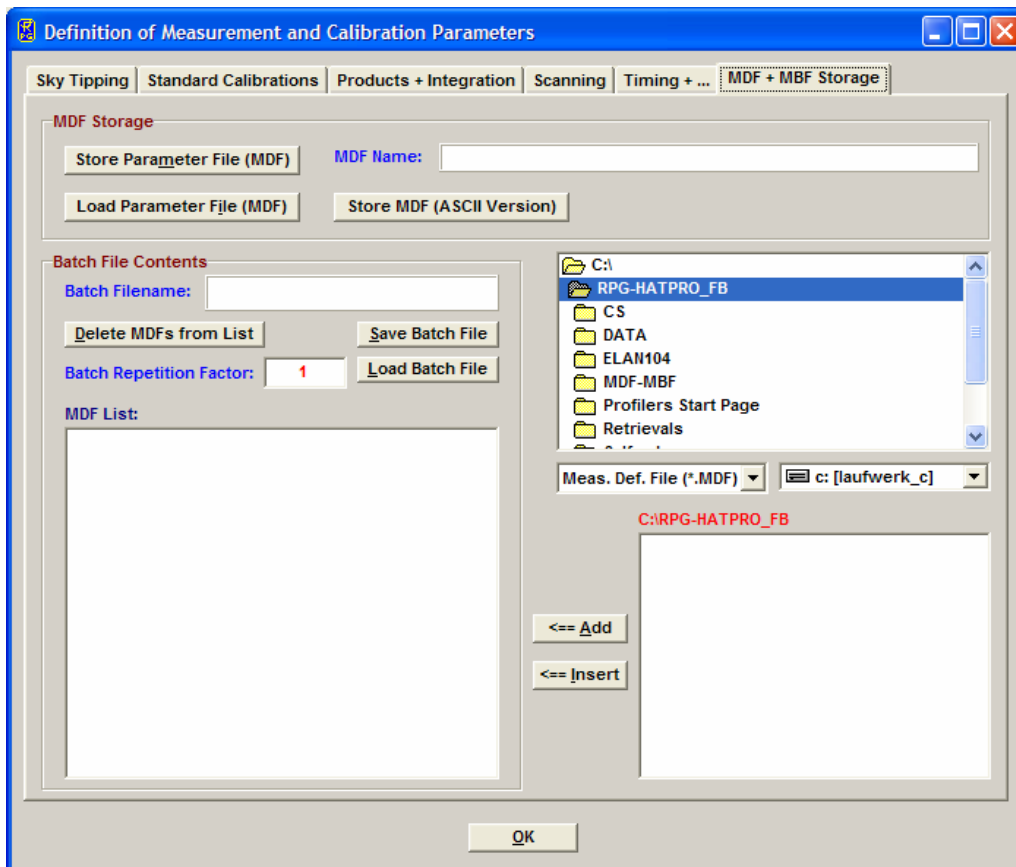

Fig.5.10: Batch file configuration menu.

It is **not** possible to send a MDF directly to the radiometer. MDFs are gathered into a MBF (measurement batch file). The concept is similar to the Scan/Frame relationship for scanning. The MDFs in a batch file are executed sequentially in the order they are listed in the MDF list (see Fig.5.10). The batch repetition number has the same meaning as the frame repetition factor for scanning: The MDF list forms a loop, which is repeated an arbitrary number of times. This offers the user a flexibility of combining different measurement tasks, which would otherwise not be compatible in a single MDF, e.g. if one wants to do a scanning measurement (not possible with retrieved products) followed by a temperature profiling measurement (a retrieved product) and repeat this 100 times the solution is to define two different MDFs, one for scanning and one for temperature profiling and combine them in a batch file with a repetition factor of 100. The only restriction for MDFs in multi-MDF batches is that the UNLIMITED mode should be avoided.

It is a good practice to store all MDFs in one directory (e.g. ...\\ATPROP\MDFs). All MDFs in the selected directory are listed in the box in the lower right corner. From this list the user may select each MDF he wants to add or insert to the MDF batch list (with **<==Add** and **<==Insert**). MDFs may also be deleted from the MDF batch list. Store your measurement batch files (MBFs) in a single directory (like "...\\2CH\\MBFs").

If file backup is enabled in the MDFs and the batch repetition factor is >1 there is only one filename for each MDF available. The data of successive executions of a certain MDF in the batch loop is stored to a single file. Each time the MDF is repeated in the loop, its measurement data is appended to the file.

5.10 Sending a MBF to the Radiometer

After a batch is created it can be sent to the radiometer (assuming the host is connected to it).

This is done with  (**Send Measurement Batch File to Radiometer**).

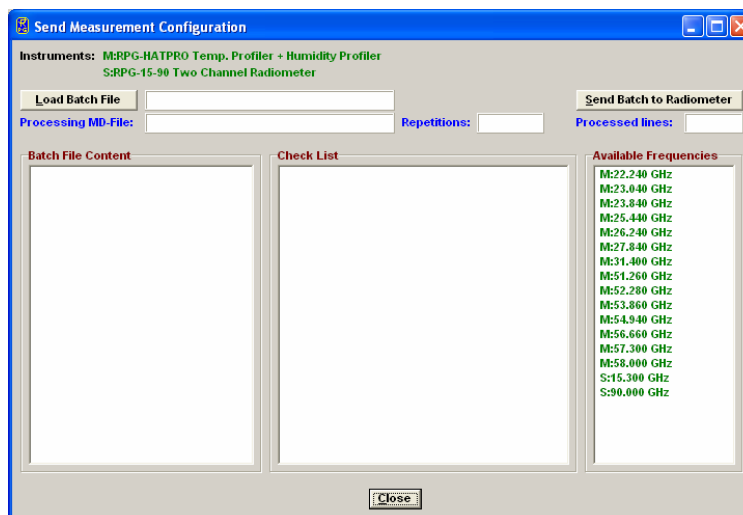

By entering this menu the host determines the current radiometer configuration (RPG-HATPRO in the example to the left).

When an MBF is loaded (**Load Batch File**) its contents and repetition factor are displayed. In addition some pre-checks are performed, e.g. correct radiometer configuration, frequency list consistency, etc. A variety of other checks ensure that no erroneous command data is sent.

When the consistency check of a MDF is finished, the test result is displayed in the **Check List**. The batch can only be sent to the radiometer if all consistency checks have finished with the status OK. Then the MBF is transmitted with **Send Batch to Radiometer**.



5.11 Commanding the Radiometer Processes

When a valid non-empty batch has been transmitted to the instrument the following functions are enabled:



(Start Processing Batch)

Although the batch is now stored on the radiometer's embedded PC, **2CH.EXE** remains in STANDBY mode, displayed in the status line on the bottom of the screen. By pressing  the batch process is initiated. The status line entry changes to "MEASUREMENT RUNNING...".



(Halt Running Batch)

A running measurement can be halted any time. This might be useful when the user wants to change the elevation angle manually. The status bar display changes to "MEASUREMENT HALTED" and the manual control button (, discussed later) is enabled which offers manual control over elevation stepper and other radiometer features.



(Continue Interrupted Batch)

Used to continue a halted measurement. The status bar display changes back to "MEASUREMENT RUNNING" and the manual control button is disabled.





(Terminate Running Batch)

This command terminates the execution of the currently running batch. The radiometer switches to STANDBY mode and is ready to receive the next MBF.

5.12 Monitoring Data

The best way to perform measurements is:

- Define a MDF and include it in a batch file (.
- Check **Automatically store monitored data** in the **Define Data Directory**.
- Send the batch file to the radiometer (.
- Start the batch file on the radiometer (.

The monitoring windows of the products that were selected in the MDF are automatically opened and the measured data is displayed (see Fig.5.11). Since the data is transmitted online from the radiometer to the host no additional file transfer is required afterwards. The file backup on the radiometer is activated for safety reasons to prevent data loss in the case of a host PC malfunction (e.g. hard disk crash, etc.).

A 24 hour history of IWV, LWP and meteorological sensors is continuously updated on the main screen. The displays can be individually changed to a 3, 6, 12 or 24 hour history.

In those monitor windows that show time series of data (e.g. LWP, IWV, met. Sensors, IR data) the time axis scale is modified by selecting the time axis width in the corresponding drop-down list of the window. Each monitor window displays the current reference time, date, sample number, sample value, retrieval type (if applicable) and cursor position (if the mouse cursor is moved into the display area).



If one of the monitor windows is closed, the data storage for that window will continue. In order to reactivate the display of a closed window, press its related speed button:

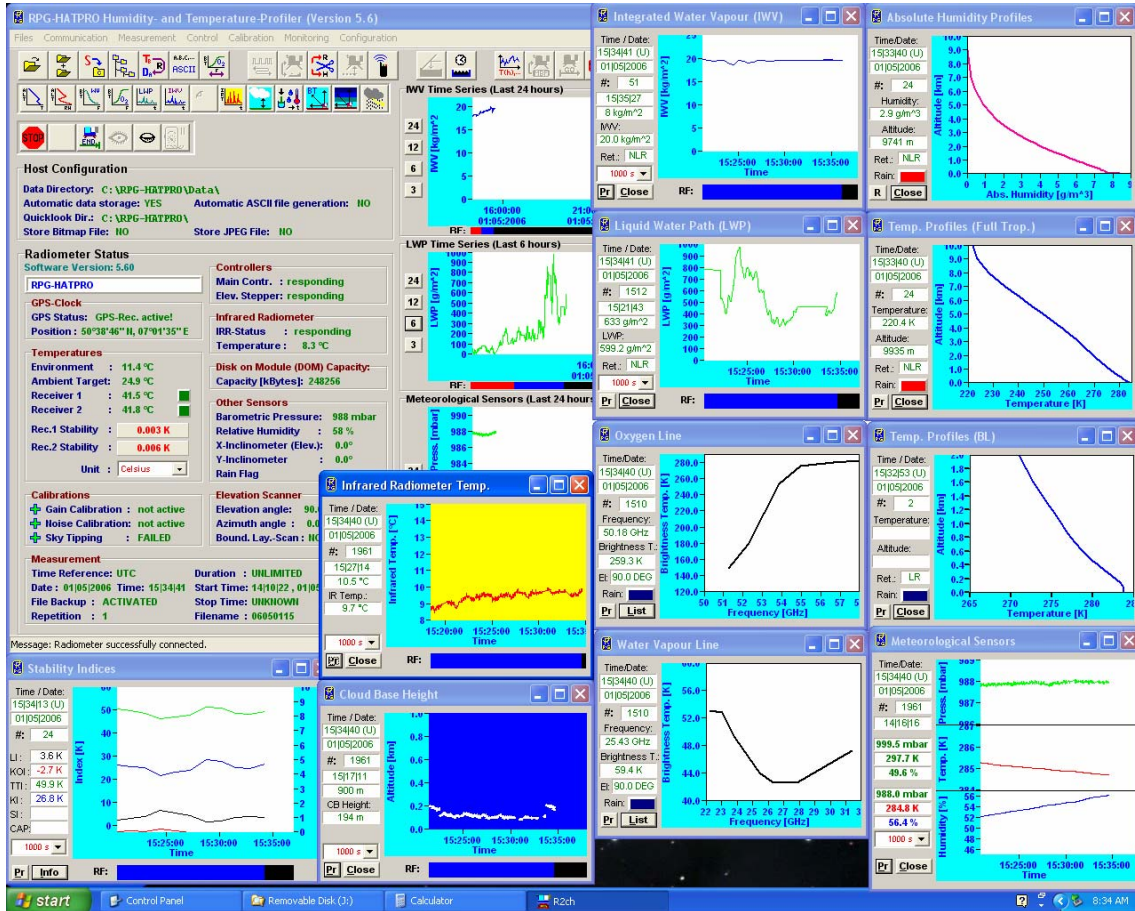

Fig.5.11: Active monitoring windows.



Temperature Profile (full troposphere)

The current temperature profile (full troposphere) is monitored. The data file generated by this window is identical to the one produced by the temperature profile chart. Only the display mode is different. When both windows are open just one data file is recorded. X-axis: temperature [K], Y-axis: altitude [m].



Temperature Profile (boundary layer)

The current temperature profile (boundary layer) is monitored. X-axis: temperature [K], Y-axis: altitude [m].



Humidity Profile

The current humidity profile (full troposphere) is monitored. The data file is identical to the one produced by the humidity profile chart. Only the display mode is different. When both windows are open just one data file is recorded. X-axis: absolute humidity [g/m³], Y-axis: altitude [m].



Liquid Water Profile

The current liquid water profile (full troposphere) is monitored. This data product is automatically generated when the products LWP, IWV and IRT are selected in the MDF product list and a retrieval for the maximum LWC is installed in the LWP retrieval directory (must have the same retrieval filename as the LWP retrieval but starting with 'LWM' instead of 'LWP'). X-axis: LW-density [g/m^3], Y-axis: altitude [m].

Example:

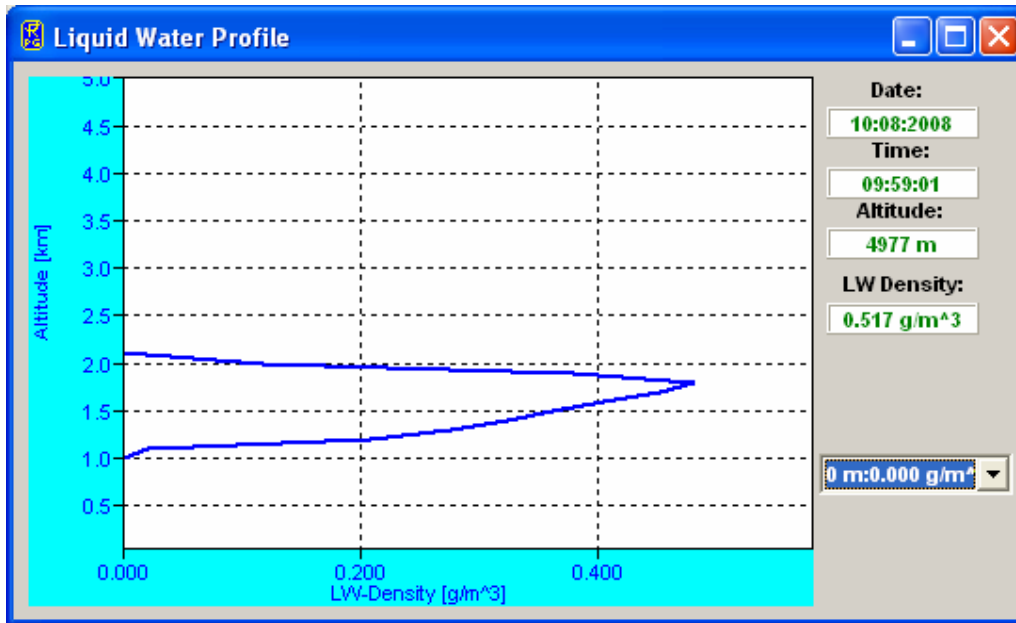

Water Vapour Line

The current water vapour line is monitored. The data file contains the line profile time evolution. X-axis: frequency [GHz], Y-axis: brightness temperature [K].

In addition the water vapour line monitoring window displays a list of brightness temperatures and a time series of all water vapour line channels (see below). This feature can be selected by pressing the *List* button and is also available for the oxygen line monitoring window.

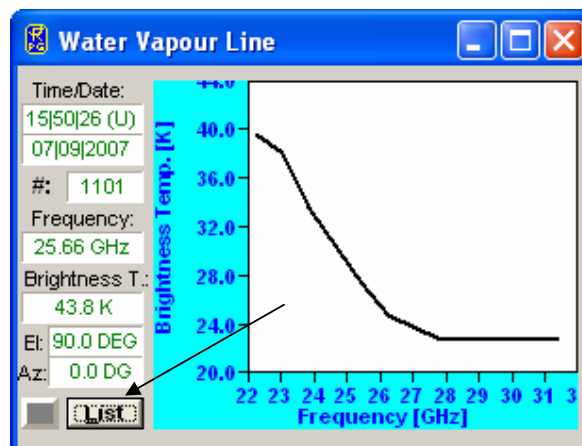

Water Vapour Line monitoring window.

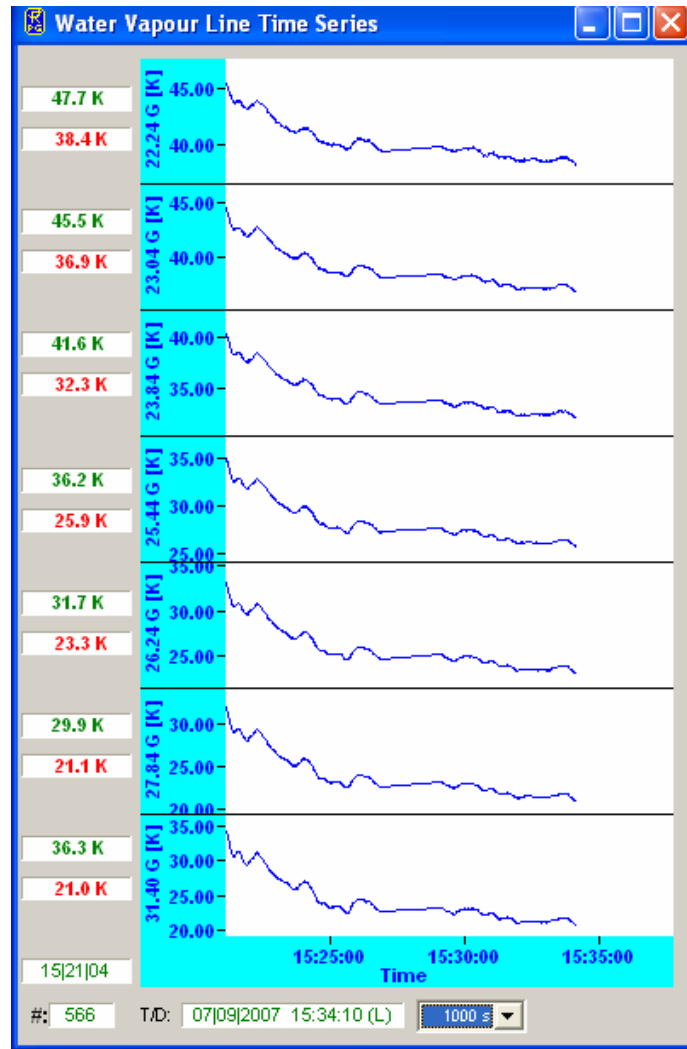

Water vapour line time series monitoring window.



Oxygen Line

The current oxygen line is monitored. The data file contains the oxygen line time evolution. X-axis: frequency [GHz], Y-axis: brightness temperature [K].



Boundary Layer Scan

The current boundary layer brightness temperature scan is monitored. The data file contains the scans of all 14 channels. X-axis: elevation angle [DEG], Y-axis: brightness temperature [K].



LWP Chart

The LWP time series is displayed. X-axis: measurement time, Y-axis: LWP [g/m²].



IWV Chart

The IWV time series is displayed. X-axis: measurement time, Y-axis: IWV [kg/m²].



Atmospheric Attenuation Chart

The Atmospheric Attenuation time series is displayed. X-axis: measurement time, Y-axis: Attenuation [dB].



Infrared Temperature Chart

The infrared temperature time series is displayed. X-axis: measurement time, Y-axis: infrared temperature [°C]. Available for all radiometer models if IRT option is installed.



Cloud Base Height

The cloud base height time series is displayed. X-axis: measurement time, Y-axis: cloud base height [m]. Available for all temperature profiling radiometer models (RPG-HATPRO, RPG-TEMPRO, RPG-TEMP90) if IRT option is installed.



Meteorological Sensors

The surface sensor data (environmental temperature [K], barometric pressure [mbar] and relative humidity [%]) time series is monitored. X-axis: measurement time, Y-axis: environmental temperature [K], barometric pressure [mbar] and relative humidity [%].



Housekeeping Data

Data like GPS position, receiver stability, system temperatures (ambient target, receiver temperatures), flash memory capacity, quality flags and system status flags is monitored.



Stability Indices

Six of the most common stability indices (lifted index, K-index, Showalter index, CAPE index, total totals index) are monitored. X-axis: measurement time, Y-axis 1: dimensionless index, Y-axis 2: CAPE index [J/m³].



Brightness Temperature Data

The time series of all available channels is recorded. The TB window provides four window buttons (W1-W4) which graphically display a subset of the total TB channel set as shown below.

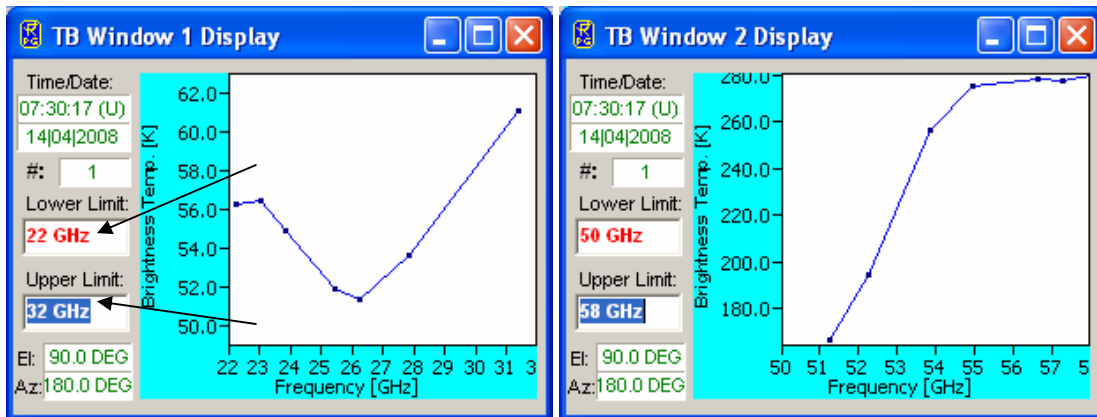

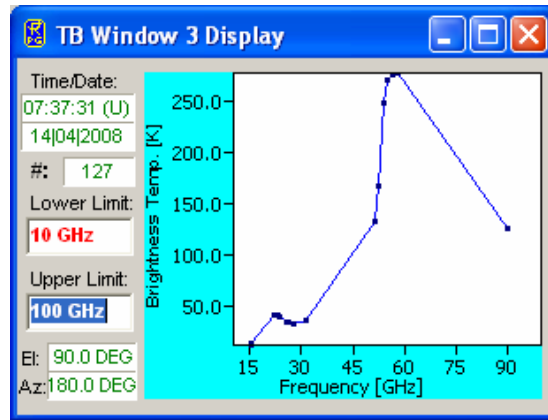

5.13 Concatenate Data Files

In UNLIMITED termination mode the radiometer periodically generates new data filenames (e.g. every hour). It is often desirable to concatenate data files of the same type (*.LWP, *.TPC etc.) to form bigger files (e.g. 24 hour files). This is possible by clicking  (**Concatenate Data Files**) which opens the menu in Fig.5.12. A set of filenames is selected from the list and then concatenated to a single file with **Generate Concatenated File**.

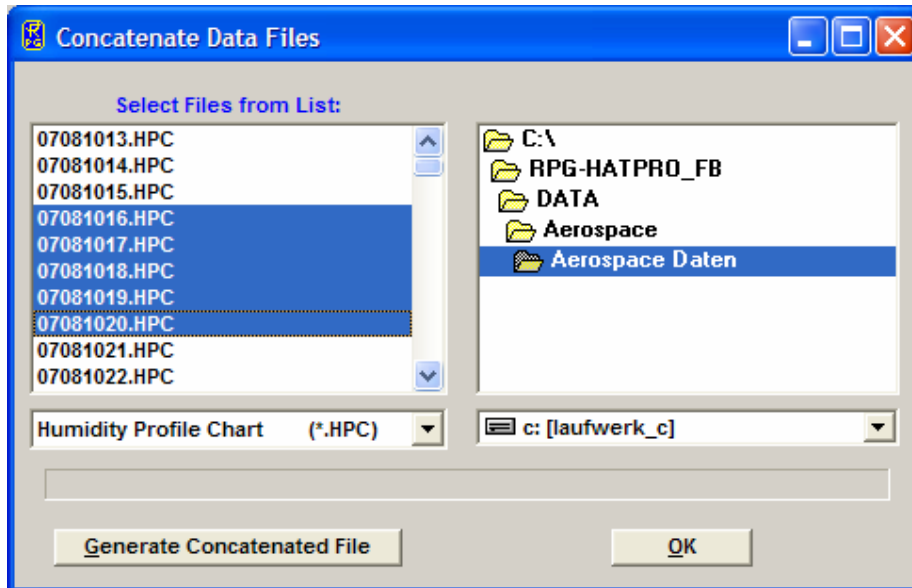

Fig.5.12: Concatenating data files.

5.14 Cutting Connection



Cut Connection to Radiometer

If the user wants to disconnect the host from the interface cable or turn off the radiometer after having been connected this command should be used first. It ensures that all communication activities between host and radiometer are disabled so that the host will not crash after disconnection.



5.15 Data Post Processing

Files of products that are based on retrievals (LWP, IWV, profiles) can be generated by combining brightness temperature files, meteorological sensor files and corresponding retrieval files. The frequencies specified in a retrieval file (see section 6) must match the frequency information in the BT (Brightness Temperature) file. Example: An LWP retrieval requires BT information at 23.8 and 31.4 GHz and input from a temperature sensor and humidity sensor. A RPG-HATPRO radiometer delivers this information in a water vapour line file **.WVL** and **.MET** file. The calculation of the LWP data is performed in the **Transform**

Brightness Temperature Data to Atmospheric Data menu (click ). Fig.5.13 shows an example. The file **04102001.MET** (double click on the filename in the list) is combined with the BT file **04102001.WVL** (double click on the filename in the list), both recorded at the same time and date, by applying the retrieval information of the **LWP_QR_CAMB_V1.RET** file. **Generate LWP File** performs a consistency check (frequency matching, additional sensor matching) and generates a new **.LWP** file.

When a humidity profile **MyFile.HPC** is created, the software automatically looks for a **MyFile.COM.TPC** file (in the same directory) containing a composite temperature profile chart (see section 5.16.3). If this file is found, relative humidity profiles are calculated by combining the absolute humidity profiles (calculated from the **MyFile.WVL** brightness temperatures) and the temperature profiles in **MyFile.COM.TPC**. The relative humidity profiles are then appended to the absolute humidity profile information in **MyFile.HPC**. If **MyFile.COM.TPC** is not found the software looks for a **MyFile.TPC** located in the same directory as **MyFile.HPC** and uses the temperature profiles of this file to create the relative humidity information. Only if neither **MyFile.COM.TPC** nor **MyFile.TPC** are found the **MyFile.HPC** exclusively contains absolute humidity profiles. The **Rel. Hum.** Button in the **Display Absolute Humidity Profiles** menu is then disabled when loading the **MyFile.HPC**.

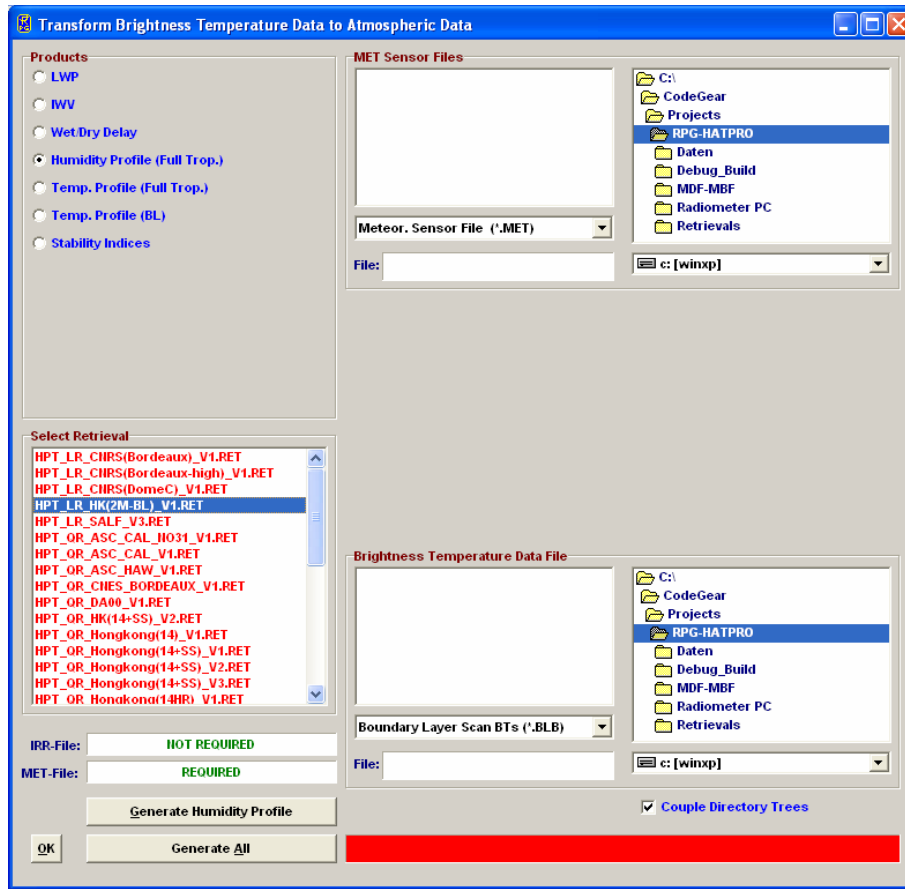

Fig.5.13: Generate level 2 data (atmospheric data like LWP, IWV or profiles) from associated BT and sensor data .

5.16 Data Display Menus

For each measurement data product a display window is available. Click on the open button and select a product from the pull down list. Then load a product data file. Fig.5.14a is an example of a boundary layer temperature profile chart.

All data display menus indicate start time, end time, time reference, duration, and retrieval algorithm (for retrieval products). Furthermore **Print** (prints window on standard printer) and **Bitmap** (same as Alt-Print Screen) functions are available.

One may zoom into the data by pressing the left mouse button in the display area and drag the mouse to a different position (mouse button still pressed) to define a rectangle (indicated by a black frame). For zooming back click **Zoom Out**.

For coloured maps as profile charts and brightness temperature charts, by clicking **Select Profile** and moving the mouse into the display area the cursor changes its appearance (). When clicking on the display area another window is opened showing the line profile or profile at the time point corresponding to the cursor position (see Fig. 5.14b). A right mouse button click exits the profile selection mode.

By clicking on **Time Series** and moving the mouse into the display area the cursor changes its appearance (). When clicking on the display area another window is opened showing the time series related to a certain altitude or frequency. A right mouse button click exits the time series selection mode.

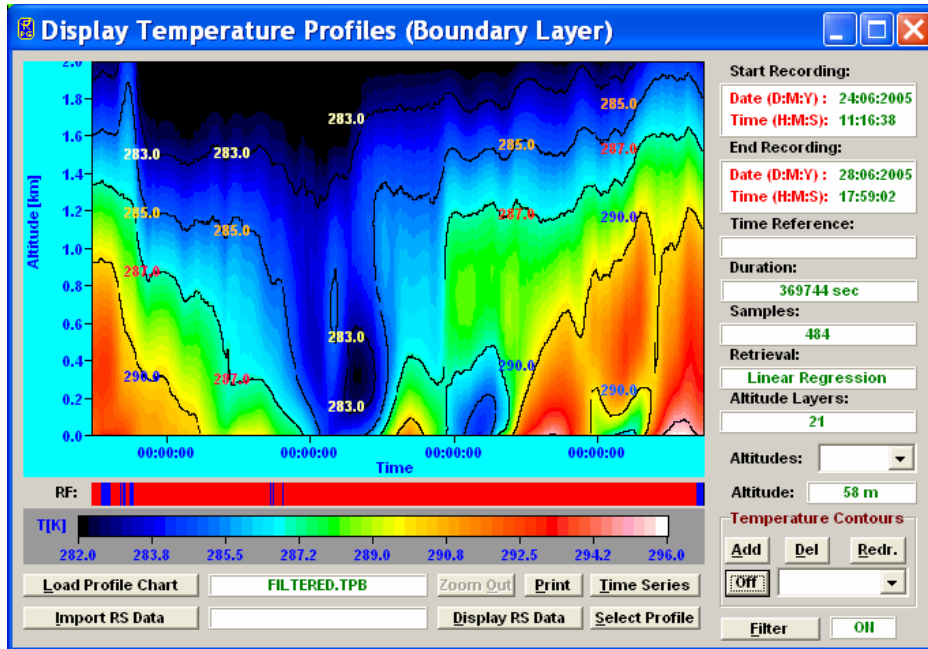

Fig.5.14a: Boundary layer temperature profile chart window.

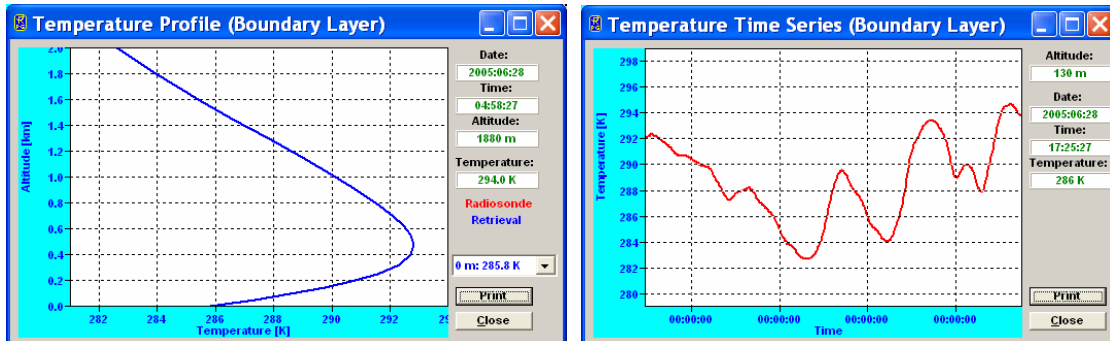

Fig.5.14b: Temperature profile and time series plots.

Brightness temperature data files always contain the elevation angle information for each sample. The elevation angle display can be toggled (*Show Angles*, *Blank Angle*). You can enter contour values in the profile charts (with *Add* and *Del*) to be plotted as lines in the coloured display. With *Redr* (Redraw) the display is updated according to the newest contour list. The contour lines are turned on and off with *On* and *Off*. Most display menus can be stretched in size (resized) by positioning the mouse on the menu window edge and drag it to the desired position. The display is then adjusted in size. All display menus show the time series of measured data with a rain flag stored for each sample in the data file. This flag is indicated underneath the data plot labelled with **RF**. During rain events the flag is coloured in blue and otherwise in red. Profile and line charts display a legend with a colour code bar. By clicking on the dark grey shaded area of the legend the sub-menu in Fig.15 pops up. When *Auto Scaling* is checked the program automatically uses the minimum and maximum numbers for the colour axis limits. When *Auto Scaling* is turned off, these limits are taken from the two entry lines labeled with *Color-Axis Min* and *Color-Axis Min*. Exiting this menu with *OK* will initiate a new plot with different colour coding.

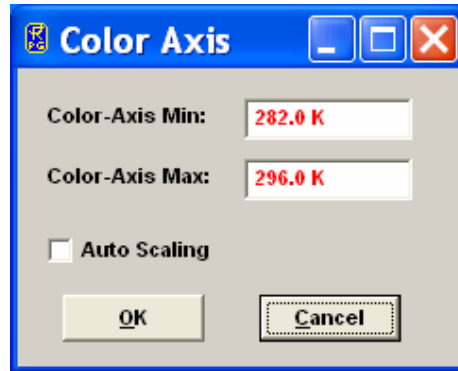

Fig.15: Colour code bar scaling menu.

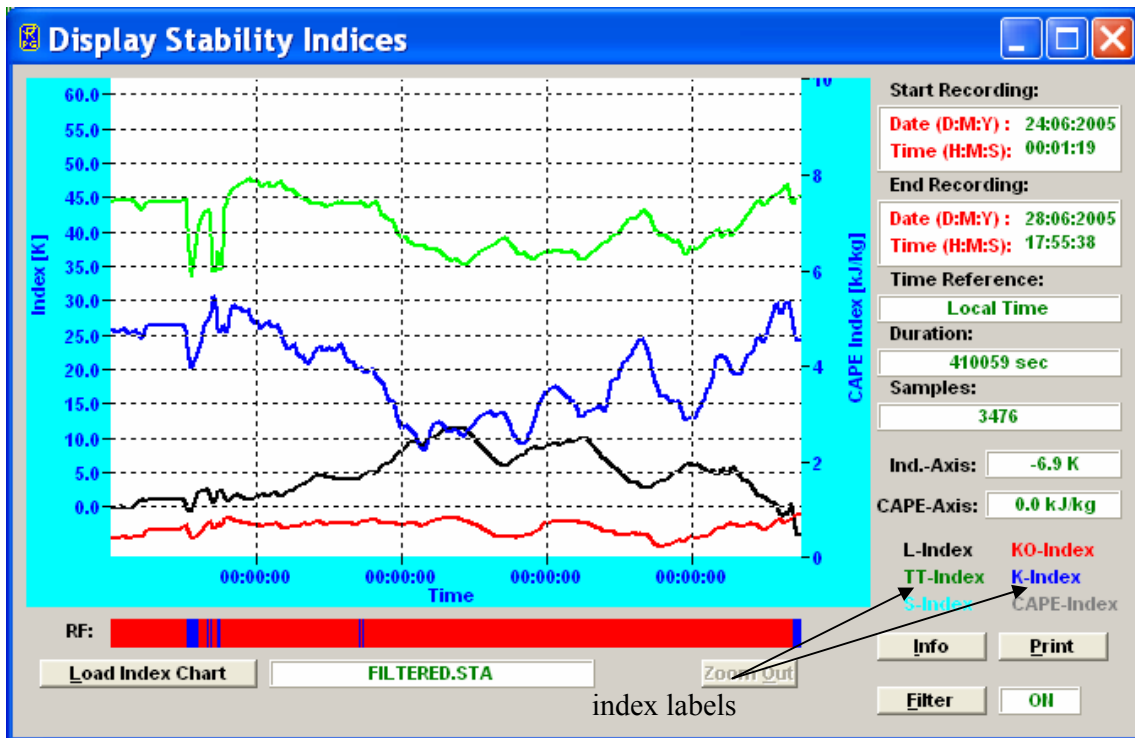

Fig.16: Stability index display. Information about a certain index can be obtained by double-clicking on the index label.

The profile display windows (like the one in Fig.5.14b) offer a similar feature. By double-clicking on the display area in these windows a similar menu like in Fig.15 is displayed which allows for automatic or manual scaling of the temperature and humidity axis' in these menus. Another type of data display is the scalar type time series like LWP, IWV, meteorological sensors, infrared radiometer temperature or stability indices (Fig.16). No colour code is required because the data type is scalar instead of a vector (e.g. a profile). The **Display Stability Indices** menu has a special information feature. By double-clicking on one of the index labels a text file is shown with information about the index definition and thresholds for severe weather conditions.

5.16.1 Data filters

Most data displays offer a filter function sub-menu accessed by clicking **Filter**. The window in Fig.17 appears. The filter can be turned on/off by checking/unchecking **Enable Filter**.

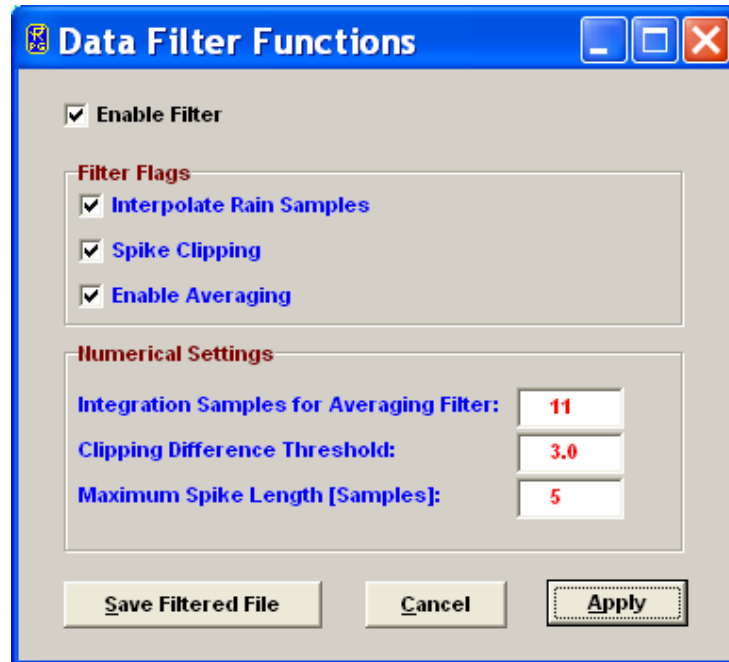

Fig.17: Filter functions sub-menu.

Three filter flags can be selected:

Interpolate Rain Samples: This filter linearly interpolates the data samples taken during rain events by using the two ‘no rain’ samples before and after the rain event. E.g. the water vapour line channels are very sensitive to droplets on the microwave radome or shutter blocking. The acquired data will not be useful in this situation and can be overwritten by this filter.

Spike Clipping: This filter eliminates sharp spikes in the data caused by blocking the microwave window during the measurement (e.g. by human beings, birds etc.). The maximum spike length measured in samples can be defined in *Maximum Spike Length [Samples]* and a clipping threshold is entered in *Clipping Difference Threshold* to distinguish the spike from general noise.

Enable Averaging: Noise on the data may be reduced by this filter. It generates the mean value of the number of samples given in *Integration Samples for Averaging Filter*. These samples are centered around the filter sample.

When pressing **Apply** the filter with its new settings is executed. The resulting filtered data file can be stored with the **Save Filtered File** command.

5.16.2 Import Radiosonde Files

The temperature and humidity profile display menus offer a feature for loading radiosonde data files to directly compare with the radiometer data (**Import RS Data**). When a radiosonde



file is loaded and the RS display toggle button shows *Display RS Data*, the radiosonde data is displayed in red as an additional plot when a profile is selected like in Fig.18:

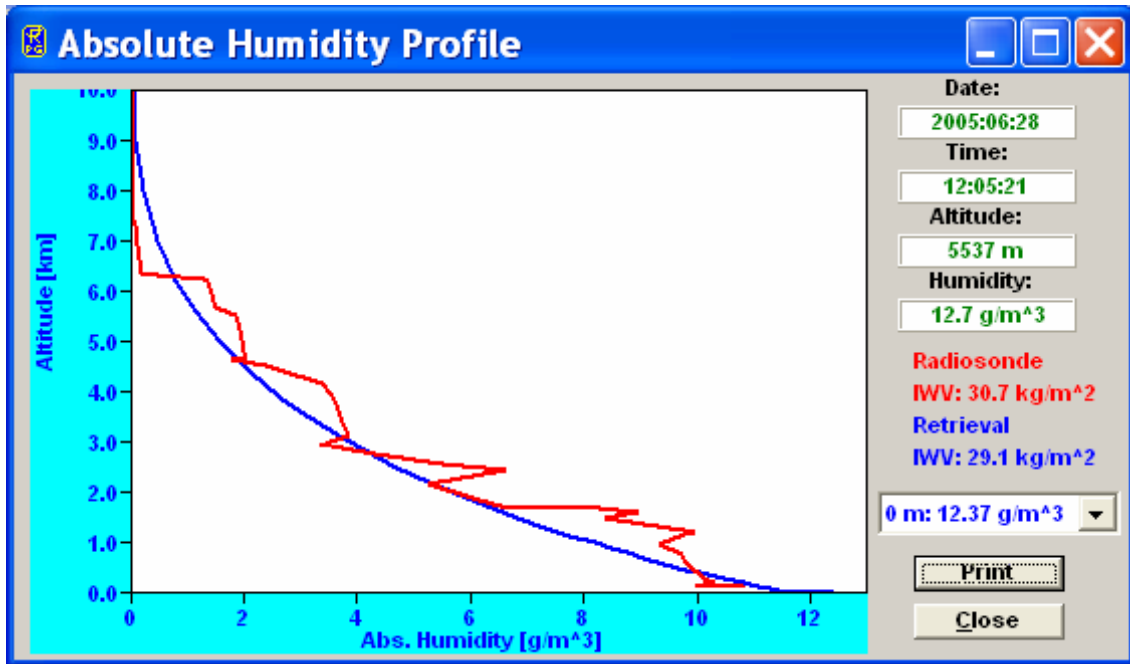

Fig.18: Absolute humidity profile with radiosonde data in red.

The figure shows a software window titled "Radiosonde File Format". It contains several configuration sections:

- Altitude:** Column: 3, Unit: m
- Temperature:** Column: 4, Unit: C*10
- Rel. Humidity:** Column: 5, Unit: Dpt
- Reverse Order
- Station Alt.: 160 m
- Radio. Alt.: 280 m
- Database section: Entry Name: (empty), Current Entry: Larkhill_FSL
- Buttons: "Load RS File", "Add to Database", "Del. from Database"

Fig.19a: Radiosonde file format definition and file loading.

By clicking the *Import RS Data* button in a profile map window one enters the *Radiosonde File Format* sub-menu in Fig.19a. Radiosonde data files (usually available in ASCII) come in a variety of different file formats.

A typical example is shown in Fig.19b. Usually the file starts with a header containing information about the station (e.g. station number) and a definition of the data columns and their units. The data is listed in columns separated by blanks, commas etc.



PRES hPa	HGHT m	TEMP C	DWPT C	RELH %	MIXR g/kg	DRCT deg	SKNT knot	THTA K	THTE K	THTV K
10410	EDZE	Essen	Observations	at 12Z	24 Jul	2005				
1000.0	60									
990.0	153	21.6	11.6	53	8.73	220	6	295.6	321.1	297.1
983.0	214	20.4	10.4	53	8.11	218	6	295.0	318.7	296.4
925.0	729	15.2	9.2	67	7.95	200	8	294.9	318.1	296.3
898.0	978	12.9	8.6	75	7.84	205	10	295.0	317.9	296.4
890.0	1053	12.2	8.4	77	7.81	190	12	295.0	317.9	296.4
867.0	1273	10.2	7.8	85	7.71	227	13	295.1	317.7	296.5
862.0	1321	9.8	7.5	85	7.60	235	14	295.3	317.5	296.6
850.0	1438	9.0	6.8	86	7.34	235	14	295.6	317.1	296.9
818.0	1756	7.4	3.8	78	6.18	226	16	297.1	315.5	298.2
799.0	1949	5.7	3.1	84	6.03	220	17	297.3	315.2	298.3
790.0	2042	4.8	2.8	87	5.96	223	18	297.3	315.1	298.4
773.0	2219	4.4	1.3	81	5.48	230	19	298.7	315.2	299.7
750.0	2465	3.8	-0.7	72	4.87	225	18	300.7	315.6	301.6
748.0	2487	3.7	-0.8	73	4.85	225	17	300.8	315.6	301.6
729.0	2695	2.3	-1.7	75	4.65	245	17	301.5	315.8	302.4

Fig.19b: Typical radiosonde data file format (ASCII). Units are m, °C and %.

Before loading such a file one has to define in which columns the program can find the three important data types Altitude, Temperature and Humidity. The user may set the right column numbers in the **Radiosonde File Format** sub-menu. For instance, in the file in Fig.19b the altitude column number is 2, the temperature column is 3 and the rel. humidity is listed in column 5.

Available altitude units are m, km, hPa and Pa. Sometimes the altitude is not stored in m or km but as the barometric pressure (e.g. mbar or hPa or Pa).

Units for the temperature are °C, K, F or °C*10. The last unit is sometimes used to keep the column data format as an integer number (e.g. 12.3°C is written as 123).

Units for relative humidity are %, 0-1 or Dpt. The most common unit is % but rel. humidity is sometimes expressed by a number between 0 and 1. A less frequent unit is Dpt (dewpoint, expressed in the same unit as for the temperature column) and the rel. humidity has to be computed from that number and the temperature reading.

Furthermore there are radiosonde file formats with reversed order, meaning that the highest altitude sample is listed first. In this case one has to check the **Reverse Order** checkbox.

For ground level correction it is useful to define the radiosonde station altitude (**Station Alt.**) and radiometer altitude (**Radio. Alt.**).

All settings can be stored in a database (file **RS.FMT** in the home directory) by clicking **Add to Database**; but do not forget to define an entry name first. Each entry is listed in the **Current Entry** list box and can be deleted from the database with **Delete from Database**.

Once all parameters for the file definition are entered the radiosonde file can be loaded with **Load RS File**.

5.16.3 Generate Composite Temperature Profiles

A special feature is available in the **Display Temperature Profiles (Full Troposphere)** menu. Usually the menu is used to display ***.TPC** files which were created in zenith observation mode. As discussed in section 2.3 and in appendix C2.3 the zenith observation mode leads to much worse vertical profile resolution in the boundary layer compared to the BL (**Boundary Layer**) mode but works best for altitudes >2000 m. Thus it is desirable to combine the

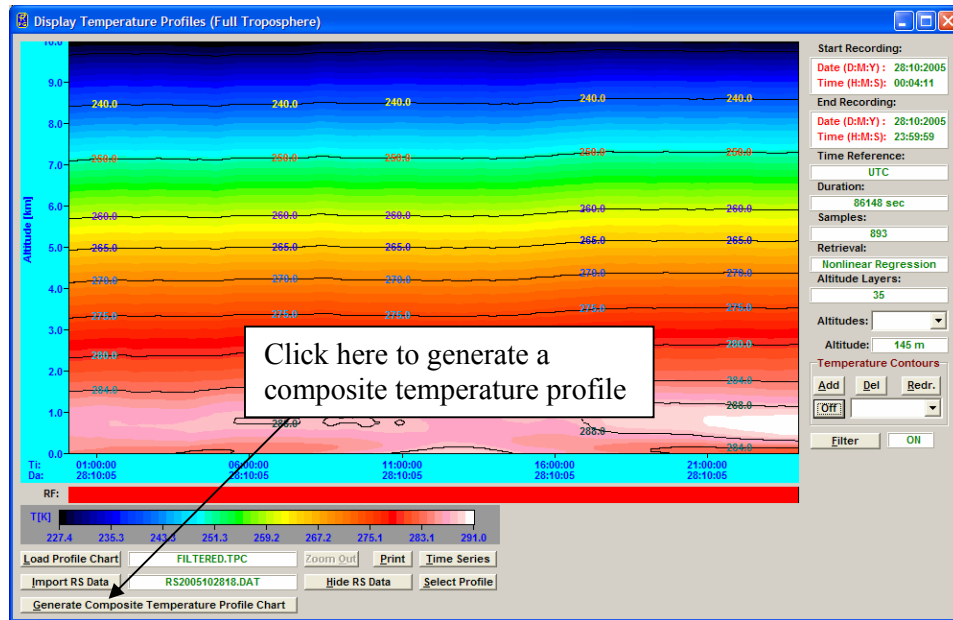

Fig.20a: How to create a composite temperature profile chart.

observations of both modes into a single data file. When a *MyFile.TPC* file is loaded to the *Display Temperature Profiles (Full Troposphere)* menu and a *MyFile.TPB* file is located in the same directory as the *MyFile.TPC*, a *MyFile.COM.TPC* file is generated when clicking the *Generate Composite Temperature Profile Chart* button. This file contains a composite temperature profile combined from the two *MyFile.TPC* and *MyFile.TPB* files. The temperature values below 1200 m altitude are identical in *MyFile.COM.TPC* and *MyFile.TPB* and the same is true for the temperature values above 2000 m which are identical in *MyFile.COM.TPC* and *MyFile.TPC*. In the altitude range 1200 m to 2000 m the *MyFile.COM.TPC* file temperature values are generated from a cubic spline fit to match both profiles in *MyFile.TPC* and *MyFile.TPB* smoothly. The cubic spline interpolation ensures that the first and second derivative of the fit match precisely the two profiles from which it has been generated.

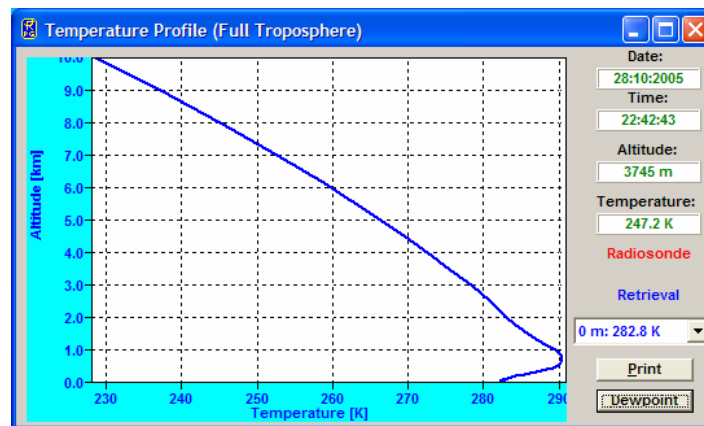

Fig.20b: Example of a composite temperature profile.



The file structure of the composite profile chart is identical to the general **.TPC* files which is indicated by the same file extension. Consequently the composite file can also be displayed in the *Display Temperature Profiles (Full Troposphere)* menu or converted to ASCII file format with the same tool as all other **.TPC* files.

5.16.4 Generate Cloud Base Height Charts

When the infrared radiometer option is installed the RPG-TEMPRO and RPG-HATPRO can measure the cloud base height by identifying the infrared radiometer temperature with the physical temperature of the cloud base (if any) and deriving the height of the cloud by using the temperature profiles. The embedded radiometer PC automatically generates the cloud base height charts (**.CBH*) when infrared radiometer data is acquired and temperature profile data is available. The same is true for the host PC when it monitors IR data and temperature profiles. Even though a post-processing is possible which means a manual generation of a *MyName.CBH* file from a *MyName.IRT* + *MyName.TPC* or *MyName.CMP.TPC* file. The *MyName.CMP.TPC* file (if available) is always preferred over the *MyName.TPC* file because the composite temperature profiles are more accurate than those derived from zenith observations only.

The manual post-processing of IRT and TPC data is performed in the IR data display window as shown below.

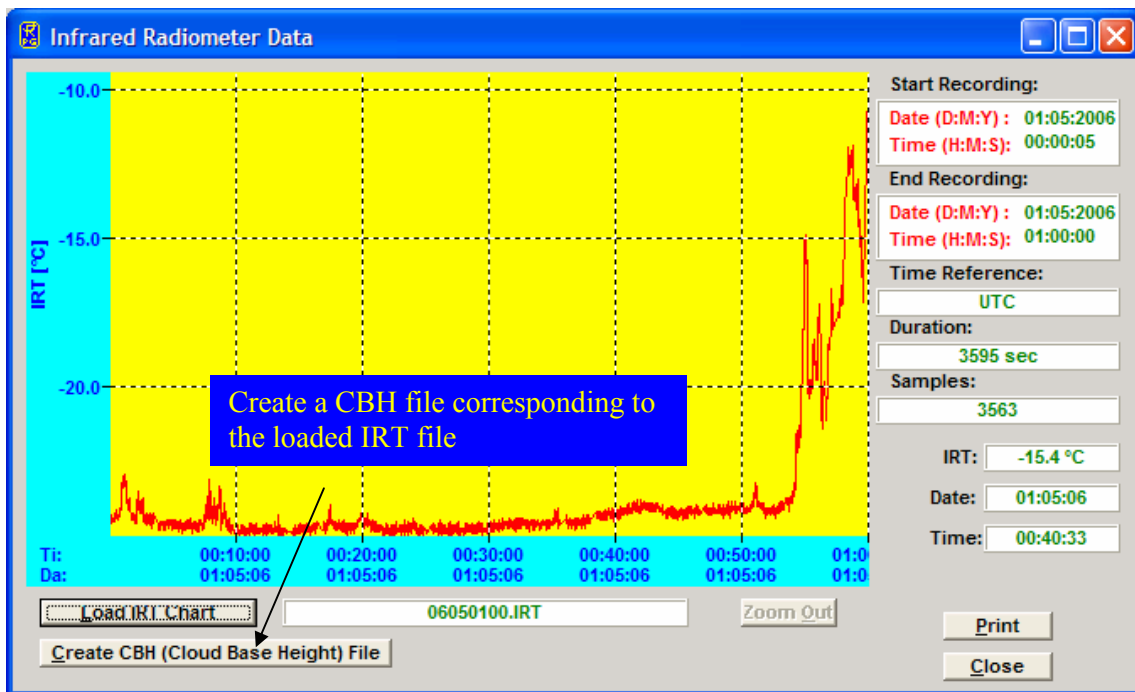

5.16.5 Housekeeping Data Display

When housekeeping data is displayed, six different display windows are available, corresponding to the six data categories System Temperatures, Receiver Stability, GPS Position, Quality Flags, System Status Flags and Flash Memory.

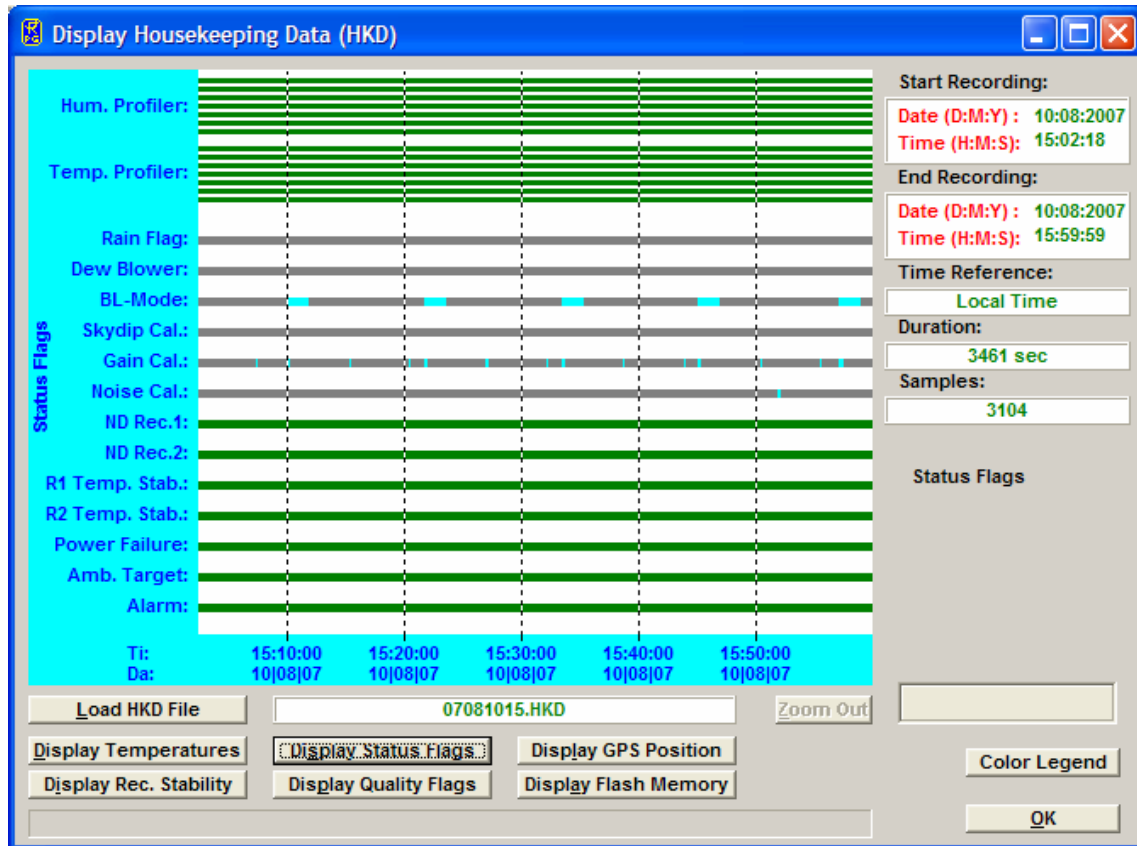

For more details on these data types please refer to Appendix A17. After a HKD file has been loaded, one can display each of the data types by clicking the related display button. A colour legend explains the meaning of the different colour codes in the Quality Flags and Status Flags displays.

5.16.6 Full Sky Scanning Displays

By selecting the '2D IWV Map' () command from the Files -> Open Files list the following menu pops up:

This menu displays normalized IWV data that has been measured using the 2D scanning feature described in section 5.9.4. The central cell corresponds to the zenith observation angle and the data cells located at the edge of the diagram are related to horizontal observations. The numbers around the circle label the azimuth angle during the scan which is referenced to the instrument azimuth 0-index.

IWV is a level 2 data product which requires a retrieval file that contains the required coefficients. In a full sky scan the radiometer changes the observation elevation angle, thus a multi-angle IWV retrieval is required for a correct evaluation of the scan data. In the display above the retrieval file name is *IWV_QR_MA_MeteoSwiss_VI.RET*. The 'MA' term indicates that the IWV retrieval is a multi-angle retrieval. If the user selects a retrieval for constant observation angles, a warning message will be issued.

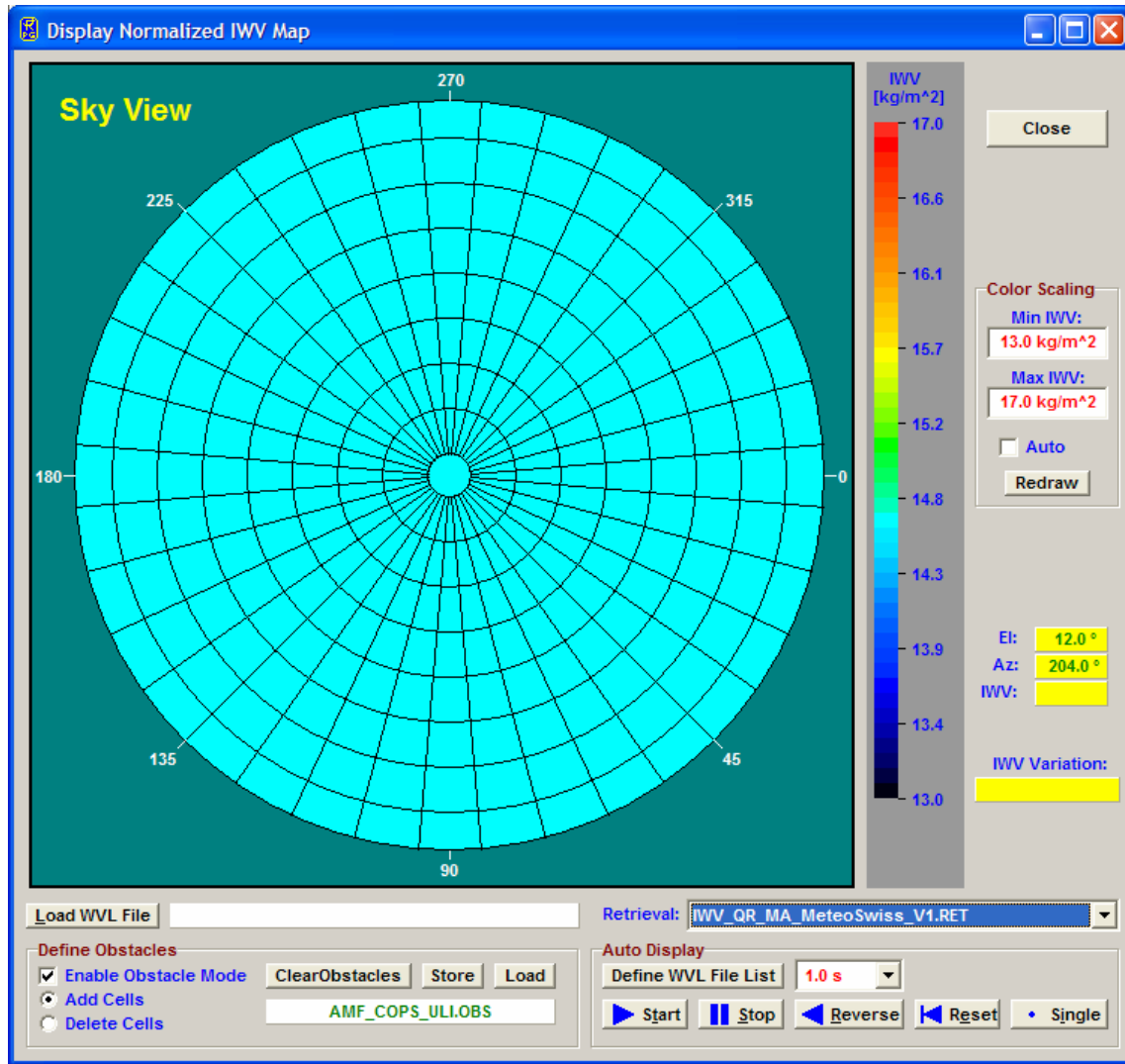

In order to display IWV data in this menu one has to load a *.WVL data file by clicking the *Load WVL File* button. After loading a data file the specified retrieval is automatically applied to convert the brightness temperature data to IWV data:

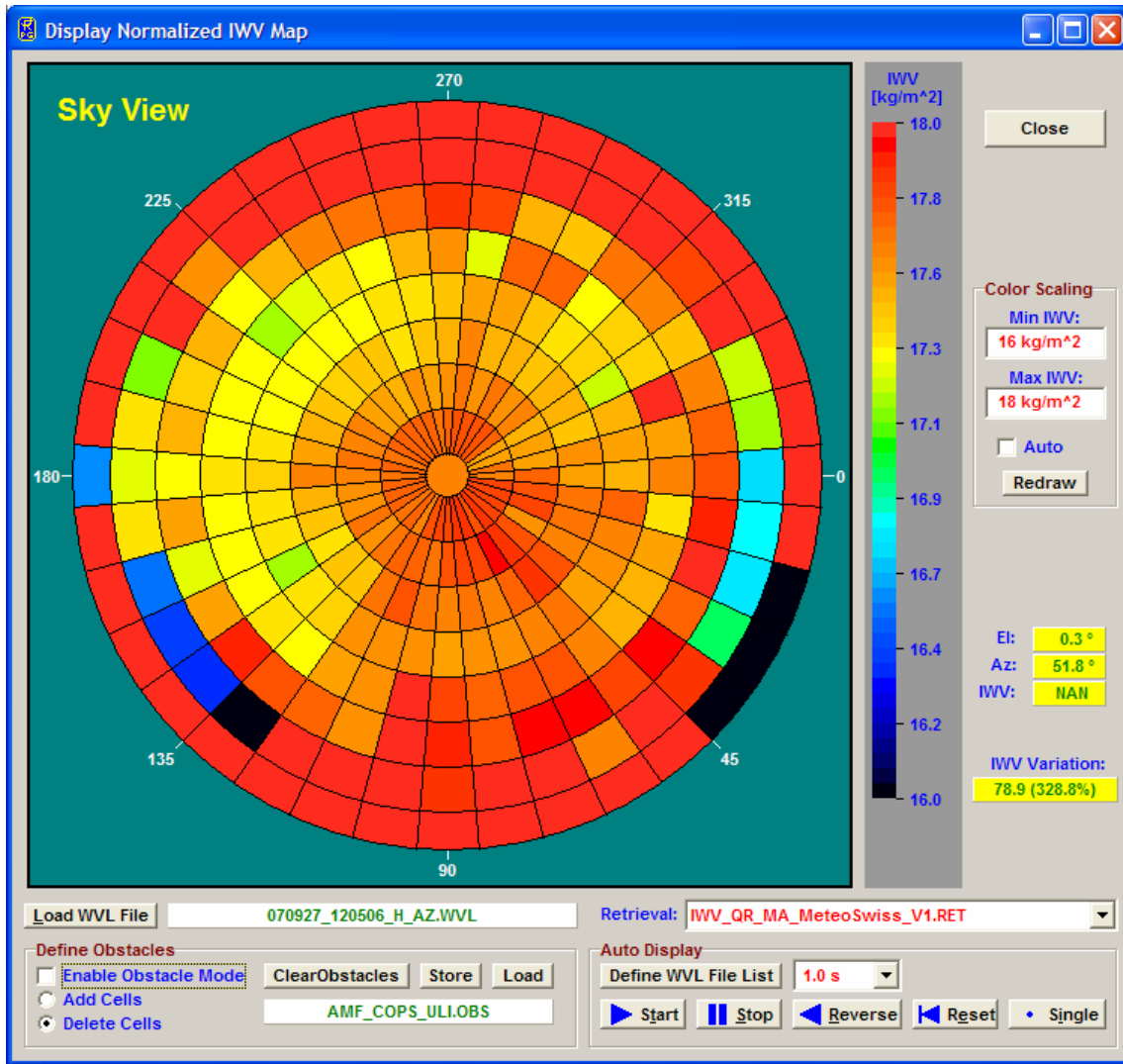

Close to the horizon the radiometer beam is often blocked by obstacles and at 0° elevation angle the beam is influenced by ground radiation. Therefore it is desirable to define an ‘obstacle’ pattern to mark those cells that are not relevant due to beam blocking. To do so, the *Enable Obstacle Mode* check box has to be checked and blocking cells can be defined by toggling the enter mode with *Add Cells* or *Delete Cells* and clicking on the relevant cell in the diagram. The result might look like:

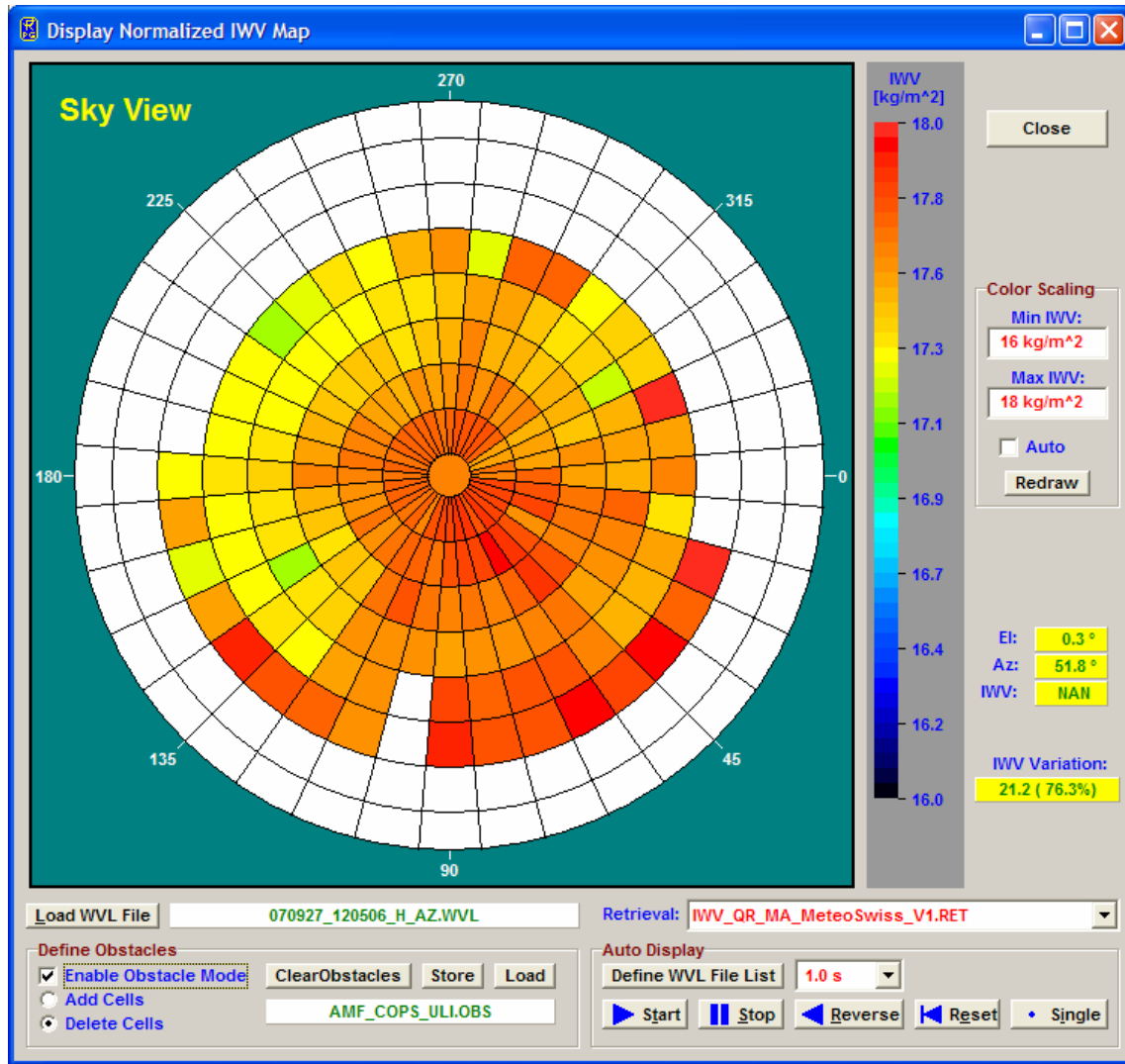

Once a cell is marked as blocked (white colour), the cell's data content is no longer be taken into account for calculations like the displayed 'IWV Variation'. When the cursor is located on a blocked cell, the data content displayed on the right of the diagram is showing 'NAN' which means Not A Number. The obstacle pattern definition can be stored and loaded using the **Store** and **Load** commands.

The colour range for the IWV display can be adjusted in the 'Color Scaling' box. For the example above the IWV variation over the full sky is about 1 kg/m².

The full sky scanning feature is typically used every 10 or 15 minutes to monitor changes of the water vapour distribution. Each scan is automatically stored in a separate data file. A 'movie' of the IWV evolution can be displayed by defining the list of *.WVL full sky scanning brightness temperature files with **Define WVL File List**. A separate menu opens where the user may select multiple files for auto display. The **Start** button starts the sequence and **Stop** halts it. With **Reverse** the file sequence is processed in reversed chronological order and **Reset** jumps to the first data file of the list. When the auto display is halted by pressing **Start**, a manual file display progression can be performed by successively clicking **Single**. In auto display mode the pausing interval between successive data file displays can be adjusted by selecting a different time from the combo box.

A similar full sky display diagram is available for LWP data. A sample file is looks like:

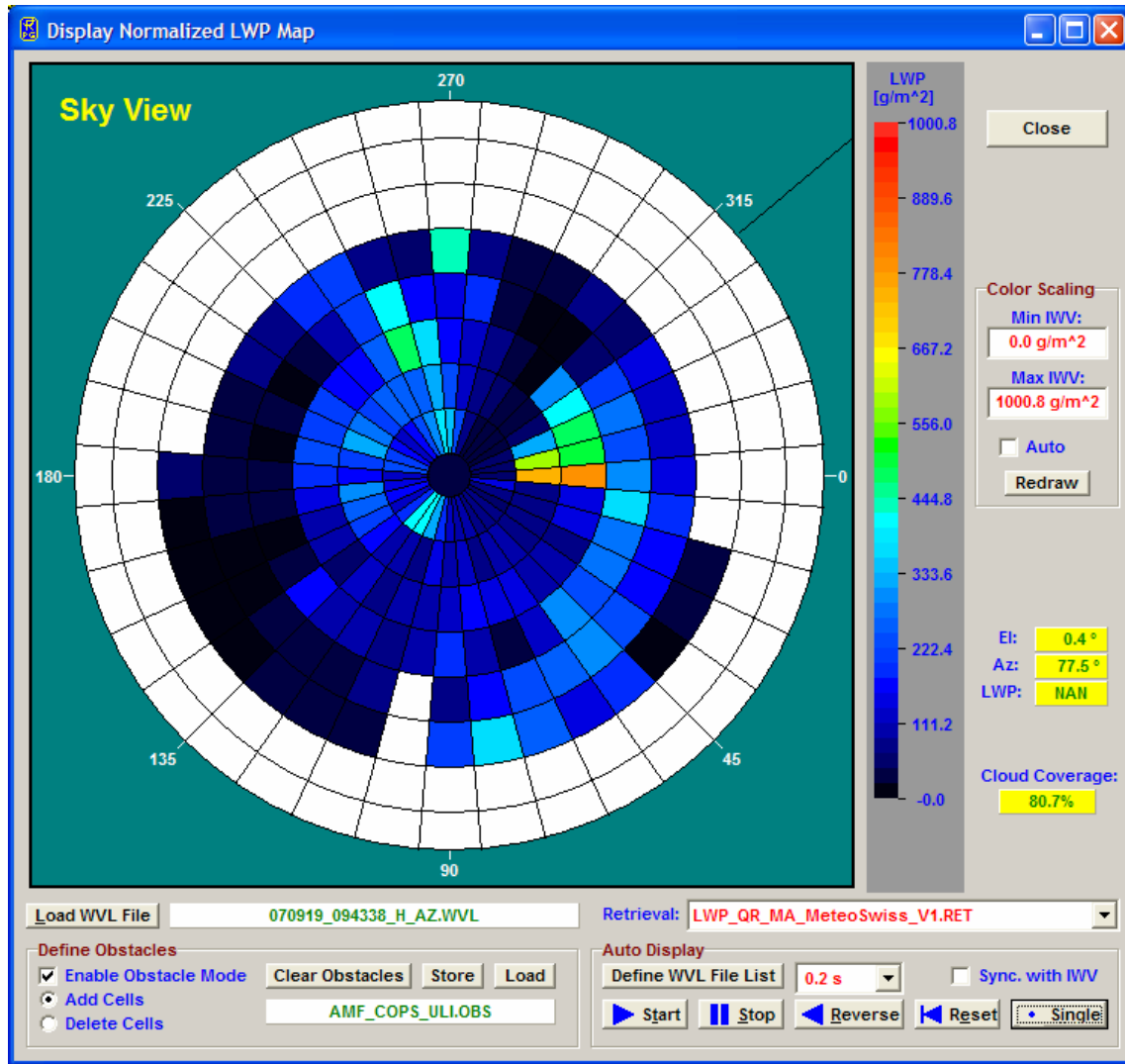

If the auto IWV display is also activated, the LWP display can be synchronized to the IWV display by checking the *Sync. with IWV* checkbox. Then the file list defined in the IWV full sky display menu is used for both diagrams and the auto display is controlled by the IWV 'Auto Display' commands.

5.17 Manual Radiometer Control

When the host is connected to the instrument and the radiometer is in STANDBY- or HALTED-mode, the manual control functions are enabled. Click (*Manual Radiometer Control*) to enter the *Diagnostics and manual control* menu in Fig.5.21.

The reason of implementing these functions is mainly for diagnostic purposes. When a radiometer is assembled every single electronic component must be tested. The receivers' long term stability is checked for several weeks by monitoring the detector voltages. However, some of the diagnostic functions are also useful for other tasks.



5.17.1 Elevation / Azimuth

The *Elevation / Azimuth* tab sheet is used (for instance) to change the observation angle during a measurement in HALTED mode. If *Reset Position* is checked the stepper is reset to its original position after leaving the diagnostics menu. If the user wishes to keep the new position he must uncheck *Reset Position*.

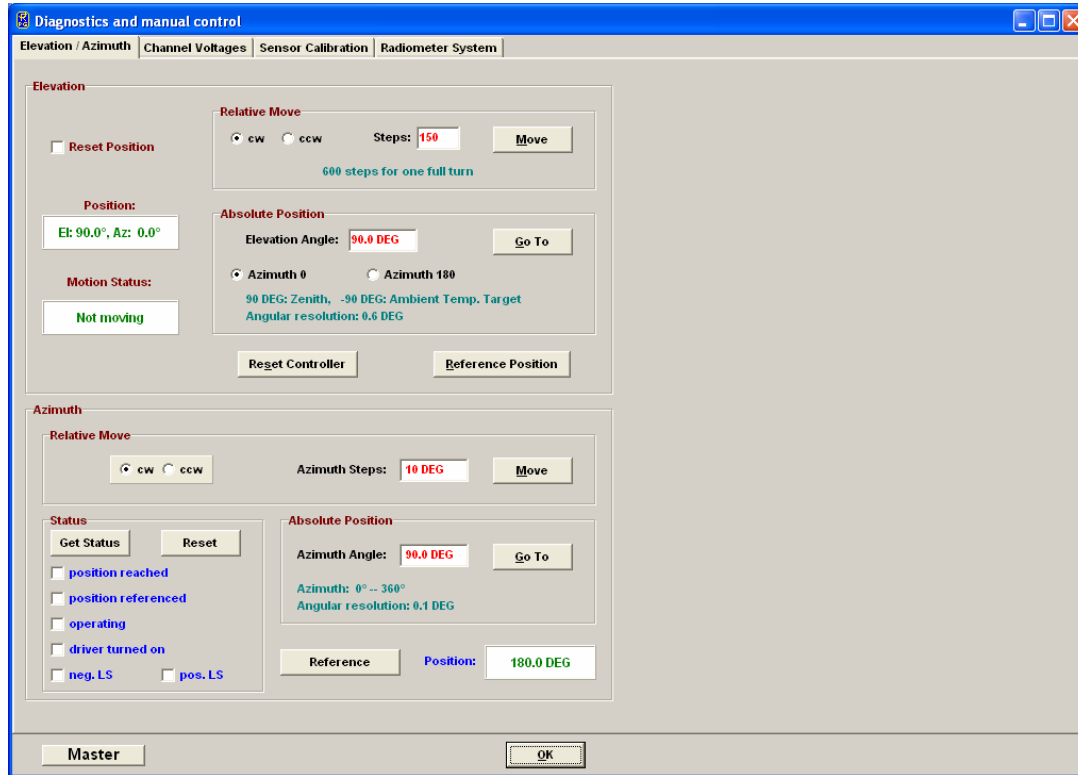

Fig.5.21: The stepper / azimuth positioner control tab sheet.

Elevation stepping positions can be set relative in stepper units (600 units correspond to a full turn) or absolute in DEG. Since the stepper can move to both sides of the radome window the azimuth angle flips from 0° to 180° when the mirror crosses the zenith direction.

The absolute elevation stepper positions are as follows:

- Zenith: +90°
- Horizontal: 0°
- Ambient target: -90°

The angular stepper resolution is 0.6°. The azimuth value of 180° is usually not used (only in Sky Tipping Bilateral Mode). The angle range elevation 0-90°, azimuth=0° is the **active quadrant** and is marked on the outside radiometer housing by a **red arrow**.

The **Azimuth** sub-window is only visible if an azimuth controller is connected to the host PC.

5.17.2 Channel Voltages

The *Channel Voltages* tab sheet is the main diagnostics tool (Fig.5.22).



Each of the four acquisition channels (not to be mixed up with receiver channels!) can be configured to sample one of the following data sources:

- Receiver 1 detector voltage (1:1)
- Receiver 2 detector voltage (1:1)
- Receiver 1 board temperature ($T=voltage*100$ [K])
- Receiver 2 board temperature ($T=voltage*100$ [K])
- Ambient target temperature ($T=voltage*100$ [K])
- Environmental temperature ($T=voltage*100$ [K])
- Barometric pressure ($P=voltage*1000$ [mbar])
- Rel. humidity ($H=voltage*100$ [%])

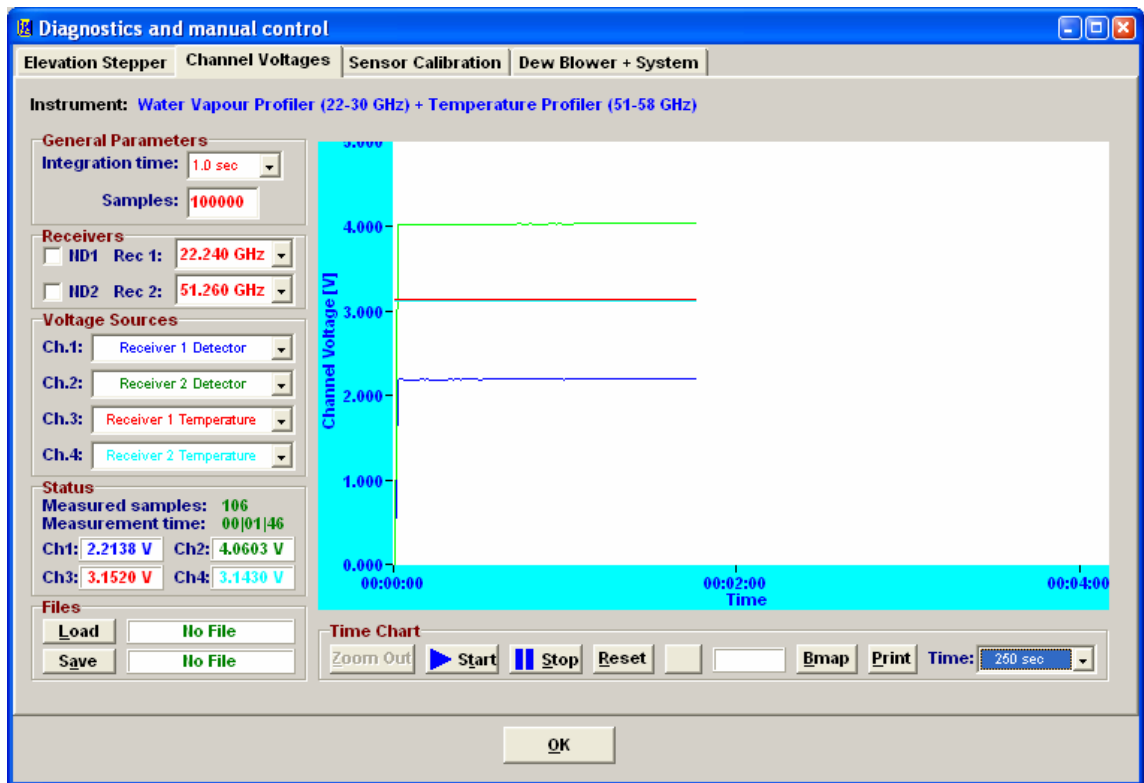

Fig.5.22: Channel voltages tab sheet.

The sample integration time and maximum number of samples are set in *General Parameters*. While sampling detector voltages, one can manually turn the noise diodes on and off to check for a correct operation (*ND1* and *ND2*). The detector voltage display can be switched to each receiver channel by selecting its frequency from the related fixed frequency list boxes (Receiver 1 and Receiver 2).

The channel readings are displayed graphically and also in the *Status* frame. Data zooming is possible. After stopping the sampling one can use a ruler to measure the precise voltage at a certain time (↓).

Reset clears the acquisition display and sets the Y-axis to +5 V (maximum).



5.17.3 Sensor Calibration

This tab sheet is needed to calibrate the thermal sensors, pressure sensor, humidity sensor and infrared sensor. It is not intended for user purposes. The sensor calibration must be performed by qualified personal only and is done before the radiometer delivery.

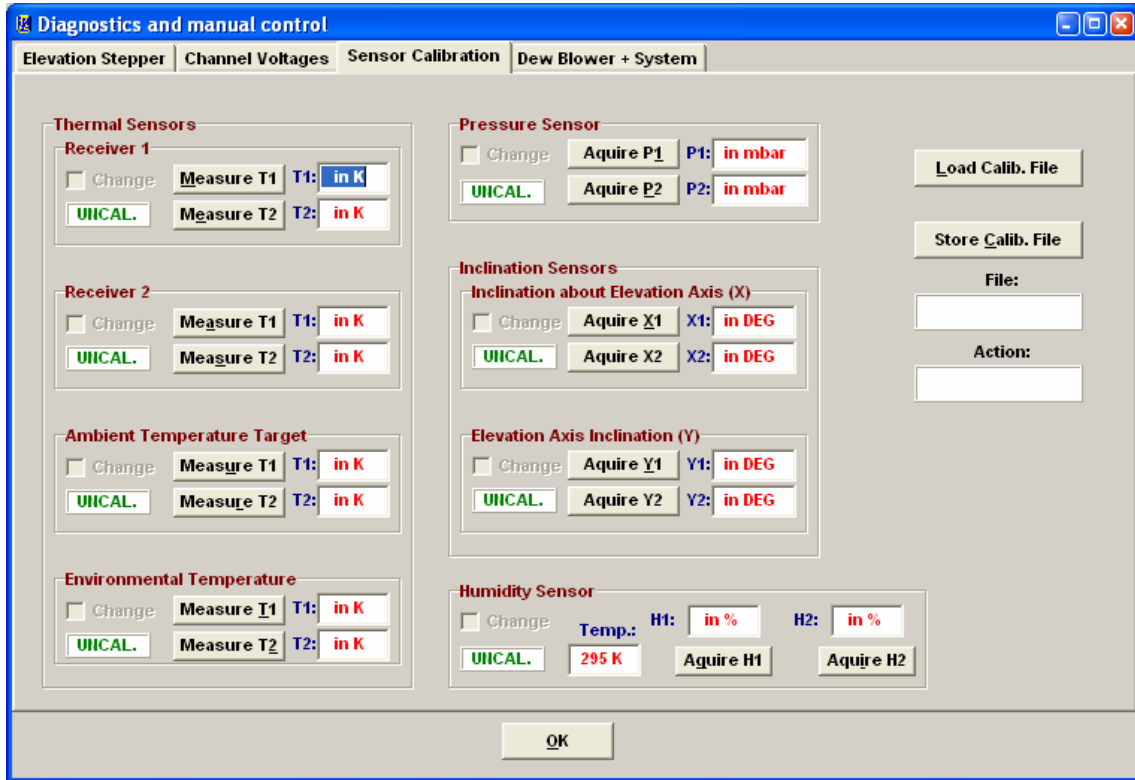

Fig.5.23: Sensor calibration tab sheets.

5.17.4 Radiometer System

The tab sheet in Fig.24 comprises a manual toggle for switching the dew blower's speed to low and maximum (*Speed Toggle* button). This feature is used for test purposes only to check the blower's performance and switching capabilities.

A very useful feature is the *Reset Radiometer PC* function. When an update of the radiometer software has been performed by transferring a new *2CH.EXE* file to the radiometer's system file directory, a radiometer reset is required to run the new software version. When clicking on the *Reset Radiometer PC* button a warning message is displayed to inform the user that if he confirms to continue this command this will result in a radiometer reset and requires a re-connection to the radiometer afterwards.

The *Reload Configuration* function sends a configuration inquiry to the radiometer which is then displayed in the *Radiometer Configuration* box. The information shown gives an overview of the types of installed hardware and important system settings.

Power Failure Handling can be disabled (*Clear Recovery Mode*) or enabled (*Set Recovery Mode*). When enabled, the power failure handling automatically restarts the measurement on the radiometer after a power failure. When disabled, the radiometer returns to STANDBY mode after the power failure.



It is possible to manually set the radiometer time and date by using the *Set Radiometer Time / Date* function after entering the new time and date into the 6 edit boxes in the *Set Time / Date* group box. The current GPS clock time can be read with *Read GPS Time / Date*.

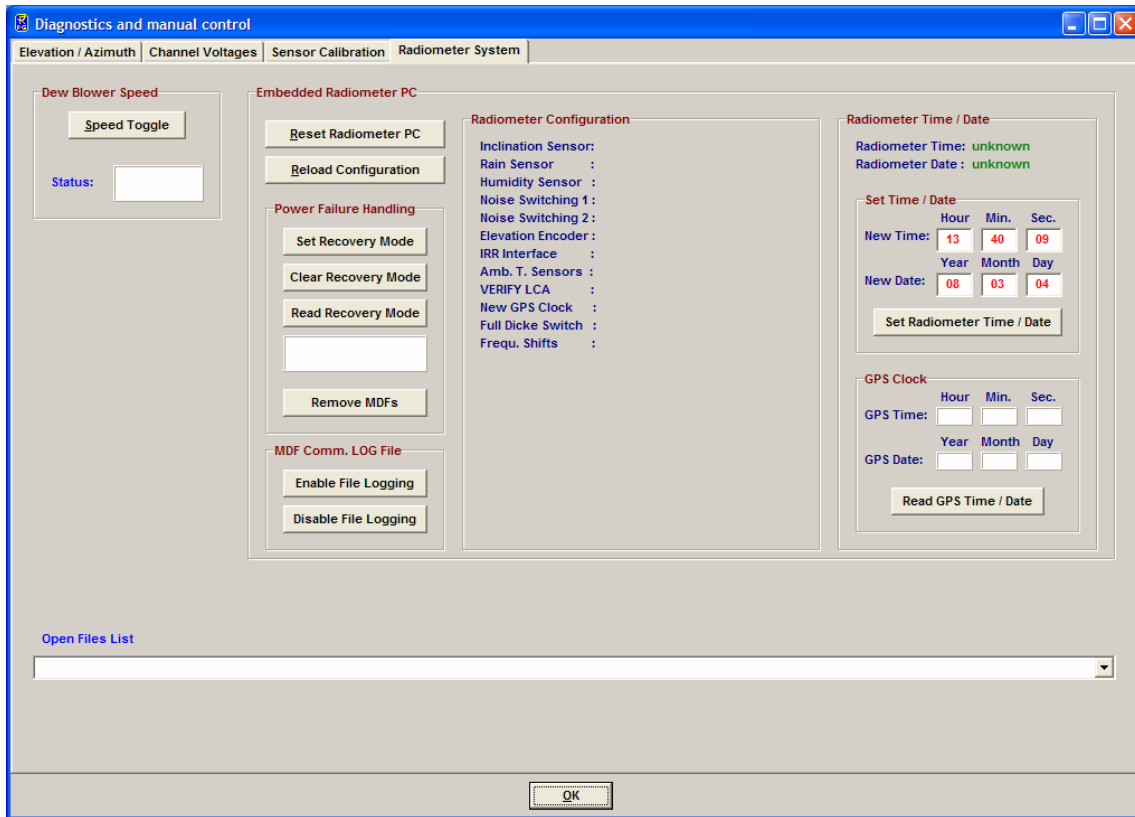



Fig.5.24: Checking the dew blower performance and controlling other radiometer features.

5.18 Transform Data Files to ASCII and netCDF Format

The standard data file format is binary (file structures listed in Appendix A) because it is more compact than other formats. In the case that a readable format is required the binary files can be transformed to ASCII. By using the  command (*Transform Data Files to ASCII Format*) a binary data file is converted to an ASCII file. The file name of the new file is the binary file name with appended '.ASC', e.g. the humidity profile binary format file *MyFileName.HPC* is converted to *MyFileName.HPC.ASC*.

Beside this manual ASCII file generation it is possible to automatically store data in ASCII format during the monitoring process (active measurement). See section 5.4 for details. Examples of ASCII files are described in Appendix B.

Another frequently used data format is the netCDF format developed for archiving atmospheric data. The manual conversion of a binary file to a netCDF file is performed by

using . The file extension of the converted file is '.NC' like in *MyFileName.HPC.NC*. Automatic conversion to netCDF format during measurements is activated in the *Define Directories and Data Formats* menu. Additional useful information added to the netCDF

file's global attribute list can be entered by clicking . The *Define Local Settings* menu pops up:

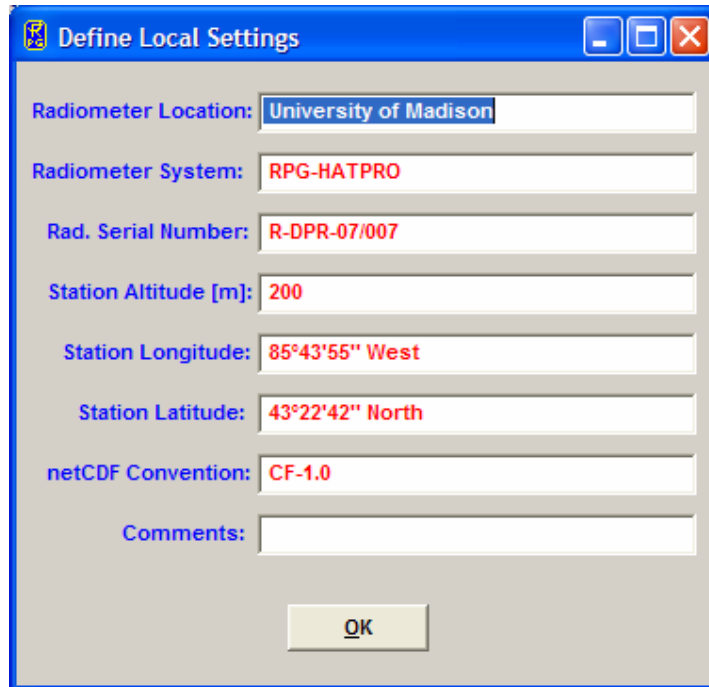

The specified information strings are then added to each netCDF file global attribute list.

5.19 Auto Viewer

It is possible to use the host software as an auto viewing tool to automatically generate level 2 data files (atmospheric data) and monitor them on the screen. The details of which products shall be displayed and which retrievals are used for the level 2 data file generation are set in the *Products + Integration* tab (see section 5.8.3) of the *Definition of Measurement and Calibration Parameters* menu. The required level 1 data files are taken from a fixed directory called *RootDirectory\AutoViewer* where *RootDirectory* is the directory containing the host software *R2CH.EXE*. If the auto viewer is activated and level 1 data is stored into the *RootDirectory\AutoViewer* directory (e.g. by an ftp job transferring data files from a server to that directory) the data is processed according to the settings in *Products + Integration* and displayed on the screen. This way the use of the *Transform Brightness Temperature Data to*

Atmospheric Data menu () becomes unnecessary.

The resulting level 2 data files and the level 1 data files from the *RootDirectory\AutoViewer* directory are then stored in the main data directory (defined in the  menu, *Define Data Directory*) and the contents of the *RootDirectory\AutoViewer* directory is deleted so that the next conversion and display cycle can follow.

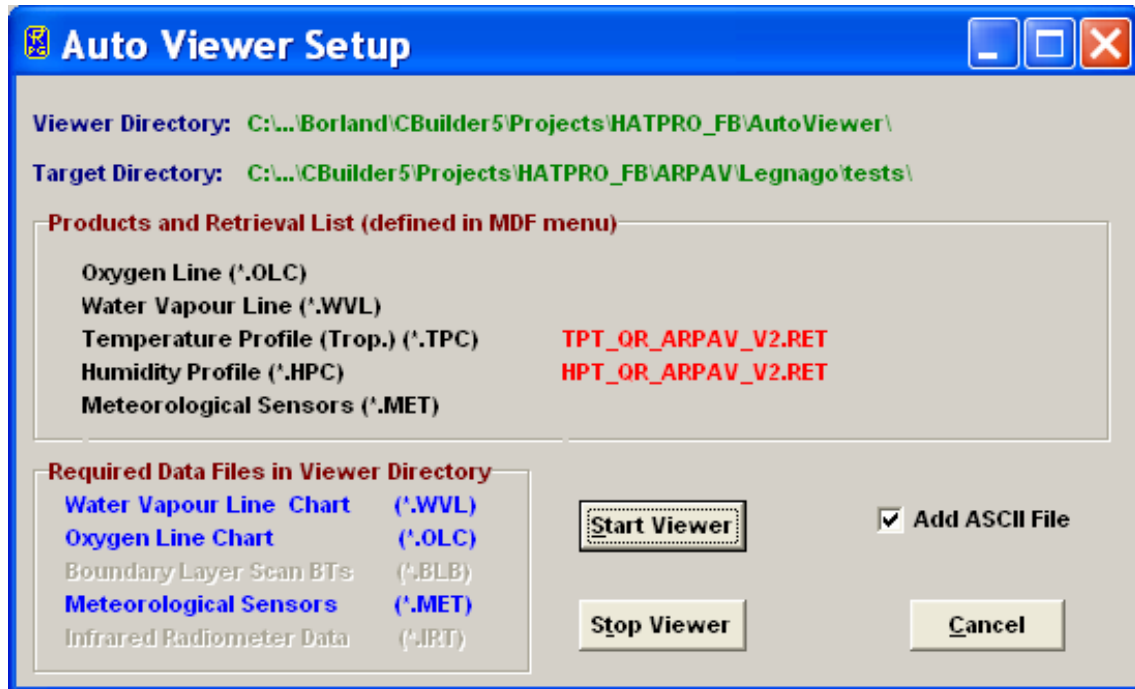



Fig.5.25: Auto Viewer Setup menu.

If level 2 data files are stored into the *RootDirectory\AutoViewer* directory they are just moved to the main data directory and displayed on the screen. No conversion takes place in this case because the files have already been generated somewhere else (e.g. on the radiometer host PC or the radiometer PC).

Fig.5.25 shows the *Auto Viewer Setup* menu that can be entered by clicking . It lists the auto viewer's directory where it looks for data files to be transformed and displayed. In addition the current data directory is displayed where the results of the auto viewer process are stored (Target Directory).

The *Products and Retrieval List* summarizes the selected products and retrieval file settings defined in *Products + Integration*. These products will be generated, displayed and moved to the data directory during the auto viewing. The *Required Data Files in Viewer Directory* summarizes the necessary files that have to be stored into the *RootDirectory\AutoViewer* directory in order to generate the files in the *Products and Retrieval List*.

The Viewer is activated by clicking *Start Viewer* and deactivated with *Stop Viewer*. In addition the user can automatically add the generation of ASCII format data files by checking *Add ASCII File*. These ASCII files are also stored in the specified data directory beside the standard binary format.

5.20 Current Sample Files

During measurements data files are automatically generated on an hourly basis when UNLIMITED mode is selected. This implies that data updates are available with a delay of at least 60 minutes when the files are remotely downloaded from the host (e.g. by an ftp server). Sometimes it is desirable to get updates more frequently. This is possible in the following way:



Enter the *Define Continuous File Generation of Current Samples* menu by clicking . A product list is displayed as shown in Fig.5.26. For each product a separate file interval can be defined. This interval determines the file length of the current samples file. E.g. when a file interval of 10 minutes is selected for the Oxygen Line Profile, a new file *CSYYMMDDHHmm.OLC* is created every 10 minutes (YY=Year, MM=Month, DD=Date, HH=Hour, mm=Minute of the date / time centred to the current CS file interval) and stored to the directory shown in the *File Directory* box on the left. The data in the current data files can be averaged by selecting a shifting average number (measured in samples). Integration times / sample and retrievals are taken from the MDF.

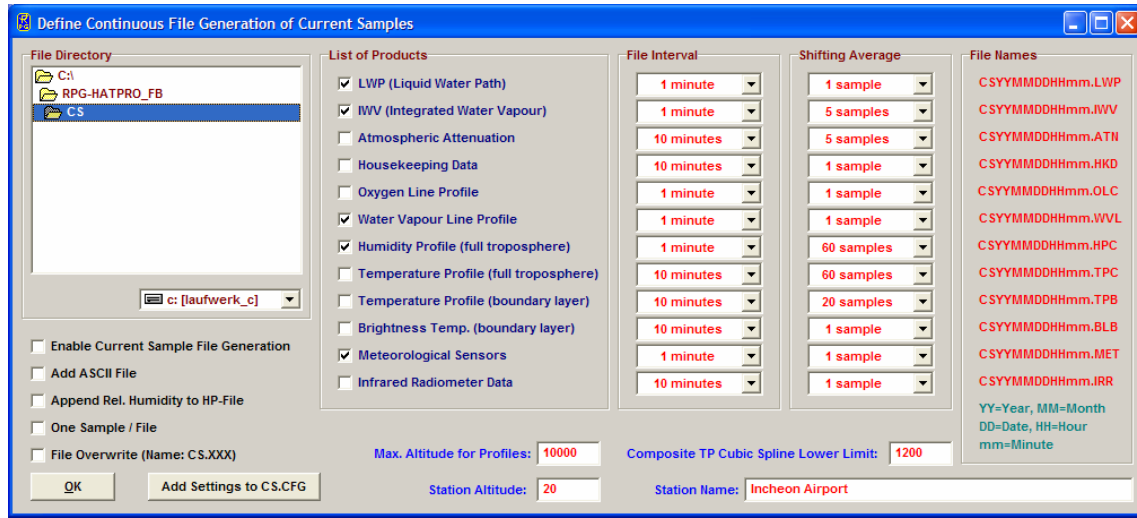

Fig.5.26: Current Samples menu showing the product list with individual file repetition and shift average settings.

The *CSYYMMDDHHmm.XXX* file creation can be enabled / disabled by checking / unchecking the *Enable Current Sample File Generation* check box. The *CSYYMMDDHHmm.XXX* file format is identical with the standard binary file format of the products. Automatic ASCII file generation is enabled by checking the *Add ASCII File* check box. For CS Files the relative humidity can be blocked to be appended to absolute humidity files by un-checking the *Append Rel. Humidity to HP-File* check box.

In the case that *One Sample / File* is activated, the program stores only the latest sample of a file interval in the CS-file. The only exception is the *.HKD CS file which is not affected by this flag.

In the case that *File Overwrite (Name:CS.XXX)* is activated, the program is not using the *CSYYMMDDHHmm.XXX* file convention. Instead, only *CS.XXX* file names are created, thus overwriting older files by the newest one.

When both ‘Temperature Profiles (full troposphere)’ and ‘Temperature Profiles (boundary layer)’ are selected from the list of products, a *CS.COM.TPC* file is automatically generated. This file contains a composite temperature profile combined from the two *CS.TPC* and *CS.TPB* files. The temperature values below 1200 m altitude are identical in *CS.COM.TPC* and *CS.TPB* and the same is true for the temperature values above 2000 m which are identical in *CS.COM.TPC* and *CS.TPC*. In the altitude range 1200 m to 2000 m the *CS.COM.TPC* file temperature values are generated from a cubic spline fit to match both profiles in *CS.TPC* and *CS.TPB* smoothly. The cubic spline interpolation ensures that the first and second derivative of the fit matches precisely the two profiles from which it has been generated.

5.21 Master / Slave Operation

RPG's profiler software is capable of handling multiple instruments and treating them virtually as a single radiometer. The internal instrument design limits the total number of receiver packages to two per radiometer, e.g. a humidity and temperature profiler (RPG-HATPRO) or a humidity profiler and 90 GHz channel (RPG-LWP-U90). Therefore e.g. a dual profiler plus 90 GHz channel cannot be combined in a single instrument. Instead, e.g. a RPG-LWP-U90 plus RPG-TEMPRO could be used in a Master / Slave configuration to realize the dual profiler + 90 GHz frequency set. The two radiometers are connected independently to the host PC which handles all the synchronization tasks of calibrations, TB acquisition, elevation/azimuth scanning etc. between the instruments.

The software combines the Master and Slave radiometers to a virtual single instrument which means that all available frequency sets from both units are stored together in brightness temperature data files (or level 0 channel voltages files), the applied online retrievals can use the total combined frequency set and scanning in elevation and azimuth is synchronized as well as all calibration procedures like skydips or other automatic calibrations. The BL mode stores ALL TBs together with the elevation angle information into BLB files.

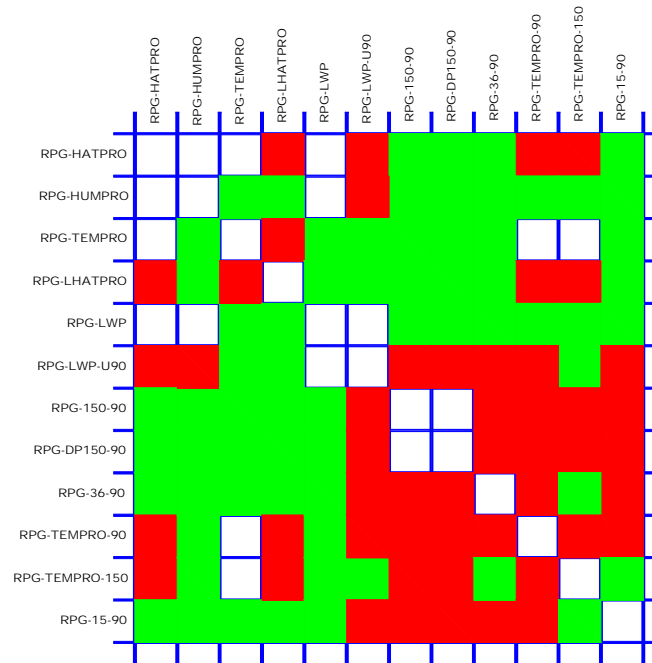

Fig.5.27: Possible Master/Slave combinations for current RPG models. Green: Ideal combination (no channel overlaps). Red: Channel overlaps

The RPG radiometer models that can be combined in a Master / Slave configuration as shown in Fig.5.27 are the following:

- **RPG-HATPRO:** Humidity and Temperature Profiler (7 channels in the 22.2-31.4 GHz range, 7 channels in the 51-59 GHz range)
- **RPG-HUMPRO:** Humidity Profiler (7 channels in the 22.2-31.4 GHz range) for mid-latitude to tropical humidity levels >2 kg/m² (2mm)
- **RPG-TEMPRO:** Temperature Profiler (7 channels in the 51-59 GHz range)



- **RPG-LHATPRO:** Humidity and Temperature Profiler (7 channels in the 22.2-31.4 GHz range, 6 channels in the 183-198 GHz range), humidity profiler for ultra low humidity levels $< 2 \text{ kg/m}^2$ (2mm)
- **RPG-LWP:** Two channel (23.8 / 31.4 GHz) radiometer for LWP / IWV retrieval
- **RPG-LWP-U90:** Humidity Profiler (7 channels in the 22.2-31.4 GHz range) plus 90 GHz channel for improved LWP accuracy
- **RPG-150-90:** Two channel (90 / 150 GHz) radiometer for the detection of low LWP levels
- **RPG-DP150-90:** Three channel (90 / dual pol. 150 GHz) radiometer for the detection of low LWP levels and ice particles
- **RPG-36-90:** Two channel (36 / 90 GHz) radiometer for atmospheric attenuation measurements. Intended as a Slave instrument for other models
- **RPG-TEMPRO-90:** Temperature Profiler (7 channels in the 51-59 GHz range) plus 90 GHz channel. Ideal combination with RPG-HUMPRO
- **RPG-TEMPRO-150:** Temperature Profiler (7 channels in the 51-59 GHz range) plus 150 GHz channel. Ideal combination with RPG-HUMPRO
- **RPG-15-90:** Two channel (15.3 / 90 GHz) radiometer for atmospheric attenuation measurements. Intended as a Slave instrument for other models

The best frequency coverage is given for the combination RPG-LWP-U90 / RPG-LHATPRO which is a triple profiler for medium/low humidity, ultra low humidity and temperature plus a 90 GHz channel for improved LWP retrieval.

Both radiometers are connected to different serial ports of the host PC. These ports have to be defined in the *Define Serial Communication Ports* menu (see Fig.5.28). The *Activate* checkbox in the Slave Port window must be checked in order to support the second radiometer. As before, an additional azimuth positioner can be connected. The host PC has to provide 3 serial ports for this configuration.

The *Define Serial Communication Ports* menu provides the checkbox *Try again, if not successful*. If this is checked, the host automatically retries a connection after a connection failure one more time.

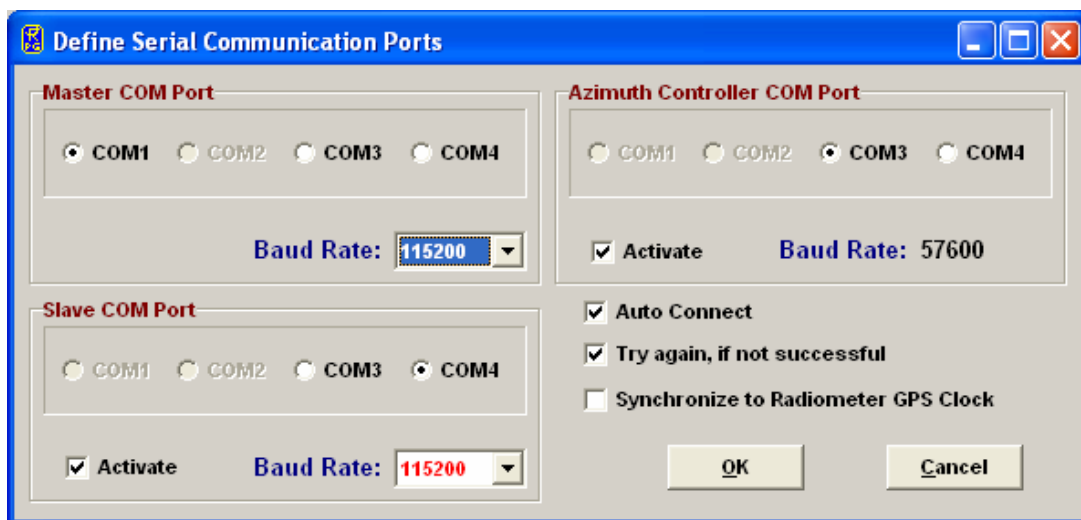

Fig.5.28 : Serial ports definition menu for combining a Slave and Master instrument.



When the host PC is connecting to the Master, Slave and Azimuth positioner, it displays the current connection status as indicated in Fig. 5.29.

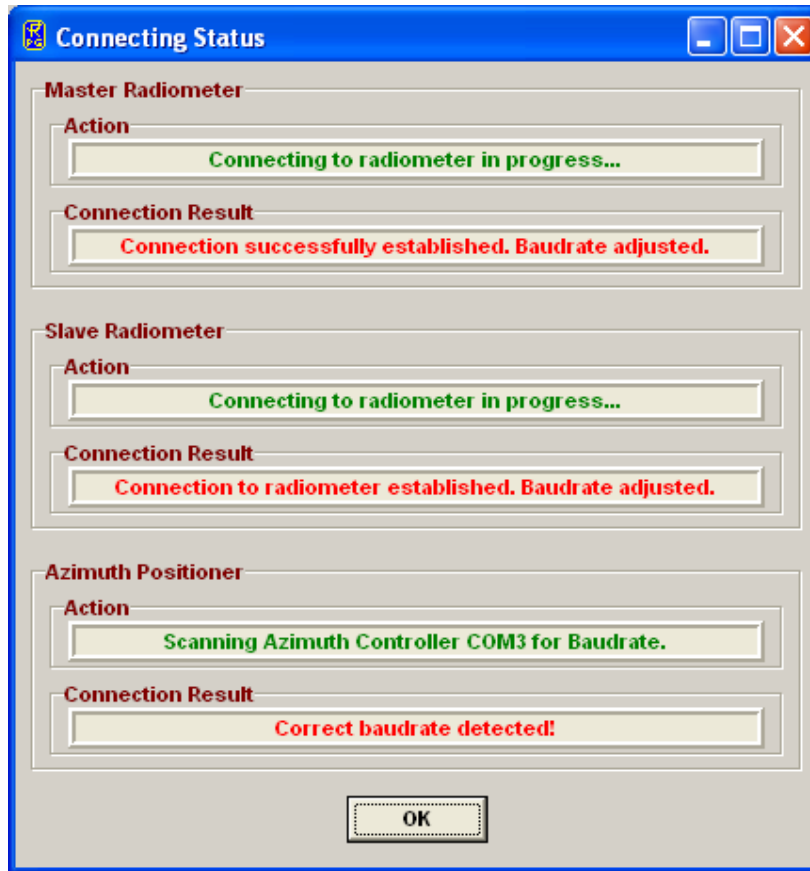

Fig.5.29 : Displaying the current connection status.

If a Master and Slave unit have been successfully detected, the host PC's main window looks as shown in Fig.5.30. The difference to the single radiometer display is that there is a toggle button in the **Radiometer Status** window to alternatively show the Master and Slave housekeeping data and instrument calibration status. In addition, there is a second status bar displayed at the bottom of the screen to indicate the Slave connection status and interface settings.

Several other menus are showing the same Master / Slave toggle button like the diagnostics menus, the file transfer menu or the absolute calibration menu. Before the user is issuing a command from one of these menus, he/she specifies the receiver of the command by pressing the toggle accordingly. Both radiometer IDs are displayed on the headlines of menus like the **Send Measurement Configuration** or the **Absolute Calibration** menu. Where frequency lists are displayed, the Master channels are preceded by 'M:' while the Slave channels are preceded by 'S:'. When enabling file backup, all data files are stored on the Master's flash memory; no data is stored to the Slave's flash.

When the HKD (housekeeping data) product is selected and a Slave radiometer is present, a second HKD monitoring window is created during measurements for the display of the Slave housekeeping data. The HKD data file names for the Slave instrument have the extension *_S.HKD instead of *.HKD (Master radiometer).

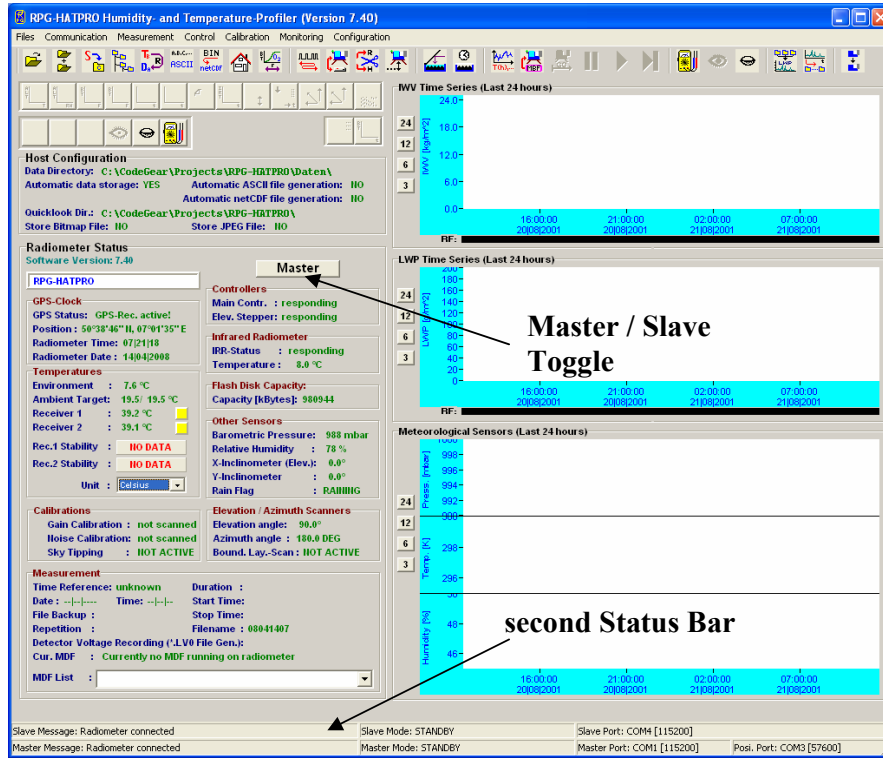

Fig.5.30 : Main window display after connecting to a Master / Slave tandem radiometer. The 'Radiometer Status' display can be toggled between Master and Slave instruments and there are two status bars on the bottom of the display to include the Slave connection status information.

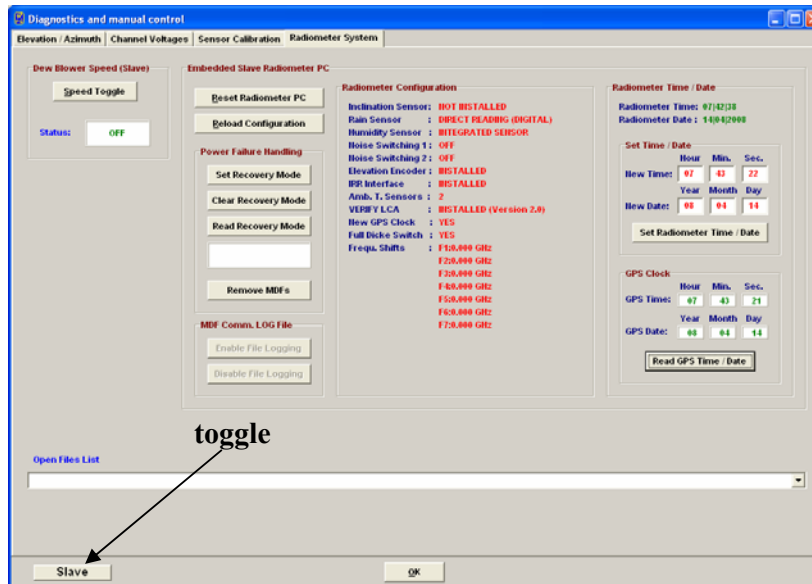

Fig.5.31 : Example of the Radiometer Systems tag when a Slave is present..

6. Retrievals

6.1 Retrieval Algorithms

In order to estimate atmospheric parameters (such as liquid water path or the humidity profile) from the radiometer data, a suitable mathematical algorithm has to be found. A statistical regression between observed atmospheric (meteorological) data and the corresponding instrument data (brightness temperatures in different channels and additional information provided by temperature, pressure, and humidity sensors within the instrument) is a widely used solution for this task, although other methods (physical retrievals) are also known to yield good results.

6.1.1 General remarks

Gathering such simultaneously observed calibration data for a specific instrument at a specific site leads to long delays before the instrument's ability to deliver atmospheric data is established. Statistical reliability calls for an observation period of several years, preferably more than one decade. During this time the atmosphere would need to be measured on a regular basis (twice a day), which also adds to the costs and impracticability. A faster approach will not use real data from the actual instrument but databases of meteorological observations. Such (radio sounding) measurements are recorded for weather prediction by many stations throughout the whole world, thus covering a vast range of climates and different weather conditions. The corresponding radiometer data needs to be calculated by radiative transfer models. This simulation is called forward modeling because the dependent data (the observable brightness temperatures) are calculated from the independent atmospheric variables. Any method or algorithm that is able to invert this process and calculate the independent variables from the dependent observations is called Retrieval.

Statistical retrieval methods use a training data set to derive a multi-linear regression, quadratic regression or an artificial neural network fit (which essentially is a form of non-linear multivariate regression). The coefficients of this regression will be applied to the radiometer measurements in order to calculate actual atmospheric variables. Quality control of the retrieval algorithms is, in general, performed in two ways: After using the training data set for establishing the regression coefficients we apply the retrieval to a second data set, the test data. This data set must not be contained in the training data. Comparing the retrieved results with the known "real" results from the test data allows for a thorough statistical evaluation in terms of bias error, RMS, correlation etc. In addition, the operational algorithms have to be tested with measurement campaigns where the atmospheric state is actually measured by independent instrumentation.

6.1.2 Data source and applicability

The amount and quality of the input data is crucial for the quality of the designed algorithm. Since a statistical algorithm can (when applied to real data) only cope with input data that is in the range represented by the training data, we need a sufficient number of samples. At least 10 years of data with two observations per day are needed to describe the natural variation of the atmosphere. Smaller time series might be missing some extreme situations which do not occur every year.

Besides the length of the time series the geographical sampling is of major importance. If only one time series which is taken at one single station is used to derive the algorithm, then the



algorithm may only be used at this specific location. Moving the radiometer to another geographical position with different weather conditions or even different altitudes above sea level will have a negative impact on the retrieval quality.

By using a multitude of weather stations for the regression data base the algorithms will be applicable to a variety of different locations. Furthermore the larger number of input data will contribute to the overall quality of the product.

6.1.3 Data quality processing and reformatting

Raw data comes in form of radiosonde data (also known as radio soundings). Such measurements contain air pressure, ambient temperature, and relative humidity at different vertical positions. Some types of radio soundings also contain wind speed and direction, but this information is not used in our type of algorithms. The number of levels (vertical resolution) typically is in the range of 10 to 20 levels up to several thousand levels.

The following steps have to be performed with the data:

1. Quality control: Depending on the data source the data may contain measurement errors, inconsistent data, and missing data. Missing data in one level leads to rejection of only that level. We check for the following error conditions and reject the sounding:
 - Increasing height in subsequent levels
 - Increasing pressure with height
 - Temperatures larger than 330 K or smaller than 210 K (190 K at larger heights)
 - Pressure larger than 1050 hPa
 - Pressure smaller than 1 Pa, surface pressure smaller than 500 hPa
 - Height larger than 70 km or smaller than -200 m
2. Applicability checks:
 - At least a 10 km height is reached with temperature and pressure information
 - At least -30 °C is reached with valid humidity information
 - At least 10 levels are present in the sounding
 - For some retrievals we reject raining clouds. These are detected by a threshold LWC larger than 3.5 g/m².
3. Reformatting: The soundings are stored in a common data format, but without interpolating or changing the data.

6.1.4 Cloud processing

From the sounding data we calculate further atmospheric parameters connected to clouds and rain. A cloud detection scheme reads the temperature and humidity vertical profiles and determines whether a cloud exists in a level or not. The criteria for cloud existence are a threshold relative humidity (usually 95 %) together with a temperature warmer than 243.15 K. These thresholds can be varied.

A second stage processing calculates the amount of liquid water (LWC, liquid water content) within each layer based on the modified adiabatic water content. This number is something like an upper limit of how much water can be present in a cloud layer with respect to the current atmospheric situation.

The above algorithms produce multi-layered clouds with several sounding levels in each cloud layer. The total amount of water (LWP, liquid water path) is calculated by integrating all cloud layers.



6.1.5 Angle and frequency selection

Prior to radiative transfer calculations the frequencies and elevation angles have to be selected. While the frequencies are mostly determined by the type of the retrieval, the angles have to be selected to meet the user requirements. Each observation angle needs its own retrieval coefficients, those coefficients depend strongly on the observation angle and cannot be interpolated.

6.1.6 Radiative Transfer calculations

In order to calculate simulated brightness temperatures from the sounding data we have to know the interaction parameters of matter with microwave radiation (absorption and scattering coefficients) at every position and every frequency that might be considered in one retrieval algorithm. Based on gas absorption models, the mass absorption coefficients are set up in every layer according to the pressure, humidity, and temperature. Cloud water adds absorption proportional to its mass with a temperature dependent absorption coefficient. At frequencies below 100 GHz the scattering at cloud droplets can be neglected. Rain clouds are not considered in the retrieval generation.

This subsection is not yet finished and still under preparation.

6.1.7 Retrieval grid and type of regression

This subsection is under preparation.

6.1.8 Algorithm performance

This subsection is under preparation.



Some users might be able to perform their own radiative transfer calculations and have access to a huge data set of radiosondes. A sophisticated design tool for the generation of system conform retrieval files is implemented in the “Files + Integration” tab sheet of the measurement definition window (see Fig.5.5). The “Define Retrieval File”-button activates the retrieval design window of Fig.6.1.

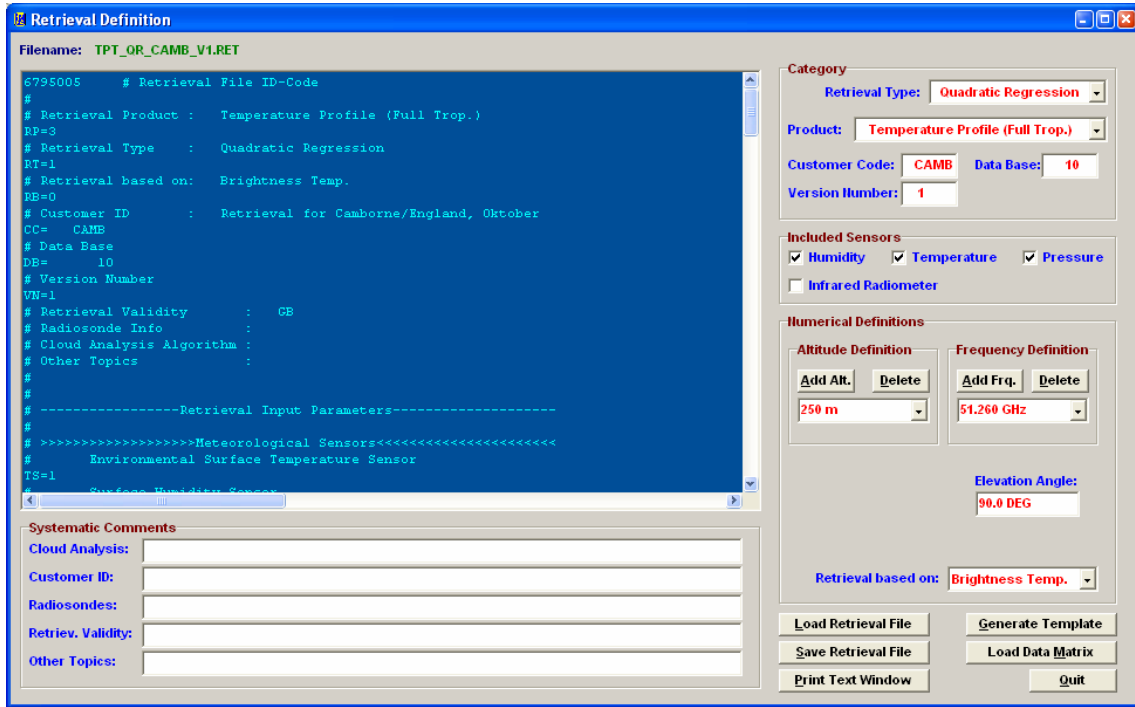

Fig.6.1: Retrieval file editor.

6.1.9 File Format

All retrieval files have the extension “.RET” to distinguish them from other file types. The first three characters of the file name indicate the retrieval product. For version 1.1 six products are implemented: TPT (temperature profile, troposphere), HPT (humidity profile, troposphere), LWP, IWV, ATN (Atmospheric Attenuation) and TPB (temperature profile, boundary layer). The next section (sections are separated from each other by the “_” character) of the file name is reserved for the retrieval type. Possible retrieval types are: LR (linear regression), QR (quadratic regression) and NN (neural networks). The third section contains the customer code and the fourth section represents the version number. The file name sections are summarized in the editor’s “Category”-frame. The data base identifier is not used for the file name but is stored into the retrieval file for future purposes.



6.2 Retrieval File Structure

With the “Load Retrieval File”-button load the “TPT_QR_JAP_1_V1.RET”-file from the “...\2CH\RETRIEVALS\TPROFILE_TROP\”-directory. Retrieval files are text files which can be edited by any editor that does not insert any control codes or other characters that do not belong to the text. The content of the loaded retrieval file is displayed in the blue editor window.

The file starts with an identification code (6795005) utilized by R2CH to detect non-conformities caused by future changes in the file format. Comments are preceded by the “#”-character. All other text lines contain relevant data needed for the retrieval computation routines (2CH).

The continue character “.” at the beginning of a line indicates that this line belongs to the same parameter as the previous line. The continue code is used in the definition of matrices to add rows to a matrix.

A parameter code of 2 characters followed by a “=” character (no spaces!) specifies the meaning of the data that follows the “=” sign. The codes for the retrieval category are:

- ‘RP=’: Retrieval product. 0: LWP, 1: IWV, 2: Attenuation, 3: temperature profile (troposphere), 4: temperature profile (boundary layer), 6: humidity profile (troposphere) (mandatory parameter).
- ‘RT=’: Retrieval type. 0: linear regression, 1: quadratic regression, 2: neural network (mandatory).
- ‘CC=’: Customer code (mandatory parameter).
- ‘DB=’: Data Base
- ‘VN=’: Version number (mandatory parameter).

These codes must precede all other codes (except for the retrieval basis ‘RB=’).

Some retrievals include the surface sensor data as input parameters beside the brightness temperature data. In the “Included Sensors”-frame the retrieval designer checks the sensors he is going to include in his retrieval. The associated codes are:

- ‘TS=’: Temperature sensor. 0: sensor not used for retrieval, 1: sensor used (mandatory parameter).
- ‘PS=’: Pressure sensor. 0: sensor not used for retrieval, 1: sensor used (mandatory parameter).
- ‘HS=’: Humidity sensor. 0: sensor not used for retrieval, 1: sensor used (mandatory parameter).
- ‘IS=’: Infrared radiometer. 0: sensor not used for retrieval, 1: sensor used (mandatory parameter).

A neural network retrieval parameter is the number of intermediate knots (hidden knot layer). The associated parameter is:

- ‘NK=’: Number of intermediate knots (Neural Network only)

The presence of these codes in the retrieval file is mandatory.

Some retrieval designers prefer the optical thicknesses as input parameter instead of brightness temperatures. The code is:



- ‘RB=’: Retrieval basis. 0: brightness temperatures, 1: optical thicknesses (mandatory parameter).

All retrievals are based on microwave frequency channels. The frequency list must be preceded by:

- ‘FR=’: Frequency list [GHz] (mandatory parameter).

All observations are performed at certain elevation angles:

- ‘AG=’: Elevation angle list (mandatory parameter).

Those retrievals that produce data at certain altitudes (humidity and temperature profiles) must have an altitude parameter specified:

‘AL=’: Altitude list [m]

All other parameters are specific for the retrieval type.

6.2.1 Linear Regressions

As was discussed before a linear regression retrieval calculation has the following structure:

$$Out_i = OS_i + \sum_{sensors} SL_{ij} * Sr_j + \sum_{freq} TL_{ij} * Tb_j$$

where Out_i is the i -th retrieval output parameter (e.g. the temperature at altitude A_i), OS_i is the retrieval offset parameter for Out_i , Sr_j is the surface sensor reading of the j -th checked sensor (the sequence is: TS, HS,PS,IS), SL_{ij} is the corresponding linear coefficient, Tb_j is the brightness temperature or optical thickness at the j -th frequency and TL_{ij} is the corresponding linear coefficient. The surface sensor readings are measured in K (Temperature), % (Humidity), Pa (Barometric Pressure) and °C (Infrared Temperature). All brightness temperatures are measured in K.

The parameters in the retrieval file are:

- ‘OS=’: offset matrix (same unit as Out_i)
- ‘SL=’: linear sensor coefficient matrix
- ‘TL=’: linear brightness temperature coefficient

6.2.2 Quadratic Regressions

A quadratic regression retrieval calculation has the following structure:

$$Out_i = OS_i + \sum_{sensors} SL_{ij} * Sr_j + \sum_{freq} TL_{ij} * Tb_j + \sum_{sensors} SQ_{ij} * Sr_j^2 + \sum_{freq} TQ_{ij} * Tb_j^2$$

where Out_i is the i -th retrieval output parameter (e.g. the temperature at altitude A_i), OS_i is the retrieval offset parameter for Out_i , Sr_j is the surface sensor reading of the j -th checked



sensor (the sequence is: TS, HS,PS,IS), SL_{ij} is the corresponding linear coefficient and SQ_{ij} is the corresponding quadratic coefficient, Tb_j is the brightness temperature or optical thickness at the j -th frequency with TL_{ij} is the corresponding linear coefficient and TQ_{ij} is the corresponding quadratic coefficient. The surface sensor readings are measured in K (Temperature), % (Humidity), Pa (Barometric Pressure) and °C (Infrared Temperature). All brightness temperatures are measured in K.

The parameters in the retrieval file are:

- 'OS=': offset matrix (same unit as Out_i)
- 'SL=': linear sensor coefficient matrix
- 'SQ=': quadratic sensor coefficient matrix
- 'TL=': linear brightness temperature coefficient
- 'TQ=': quadratic brightness temperature coefficient

6.2.3 Neural Networks

The parameters for the neural network retrieval calculation are:

- 'IM=': input coefficient matrix
- 'OM=': output coefficient matrix

The structure of these matrices can be derived from a template neural network file (see chapter below).

6.3 Retrieval File Templates

The user does not have to enter all these parameters by hand but instead defines his retrieval input and output parameters by filling the list boxes and check boxes in the retrieval editor. In addition, five comment lines may be entered for customer related information etc. By clicking on the "Generate Template"-button the editor text window is initialized with a syntactically correct retrieval file comprising all settings and numerical data is filled with zeros.

The user must generate a text file which contains the retrieval coefficients in the same row and column order as required for the template. Then this coefficient file can be loaded with the "Load Data Matrix"-button and a second editor text window is opened containing this file. The user then copies and pastes the matrices from his coefficient file editor into the retrieval file editor text window. This concept ensures that the retrieval file syntax remains correct.

7. Instrument Maintenance and Recommendations

This chapter summarizes recommended maintenance activities to ensure a high data quality and measurement accuracy of the radiometer.

7.1 Cleaning

Due to environmental conditions the radiometer can be covered with dust, spider webs, etc. The following recommendations should be taken:

- Cleaning the microwave window: Clean the microwave radome once per month with pure water or soap and a soft cloth. Never use any aggressive chemicals like acetone, alcohol, benzene or others. These substances might damage the window coating.
- Cleaning of the rain sensor: Use pure water, soap or alcohol to clean the rain sensor surfaces. A tooth brush is helpful to remove dirt from the snow catcher pins. Cleaning should be performed in periods of 6 month.
- Cooler: The air slits of the main cooler can be blocked by dust, insects etc. (see Fig.7.1). The rain protection gill sheet on the left housing side can be dismantled to get access to the cooler slits. Remove any material that might block the air flow. Check the cooler slits every 24 month.
- Cleaning of radiometer housing: Clean the housing of the radiometer every 12 month. Use a soft cloth and soap and water.



Fig.7.1: Removing the cooler cover for cleaning the cooler air inlet.

7.2 Calibrations

Except for the automatic calibrations performed by the instrument (following the settings of the measurement definition file (MDF)) a manual calibration is required when the system is transported or turned off for a longer period (> several days). This calibration is called an



absolute calibration. To perform this calibration it is necessary to mount the external calibration target to the radiometer housing (see section 4.1.2.1). Then the target is filled with liquid nitrogen and pushed into its rest position (see Fig.4.6).

The calibration is started by pressing  (*Perform Absolute Calibration*). The menu in Fig.5.6 is shown.

Start Calibration starts the absolute calibration procedure. During calibration the current activity is displayed in the message line. When the integration cycles have completed, the message *Calibration successful! Save?* is displayed and the user has to confirm to save the calibration with *Continue*. The absolute calibration parameters are then stored on the radiometer PC. Leave the calibration menu by pressing *Finished*.

If the error message *No response to cold load. Calibration terminated!* appears, the cold target was probably not filled with liquid nitrogen or was not installed at all.

No noise diode response. Calibration terminated! indicates a malfunction of one of the noise sources. Contact RPG for help in this case.

The absolute calibration should be repeated every 6 month to maintain measurement accuracy of the built-in noise standards.

7.3 Maintenance Schedule

In the table below the given maintenance intervals are average periods. Depending on the deployment site these intervals should be optimized. For instance required cleaning intervals strongly depend on climate zones (arctic, sub-tropic, etc.), the vicinity to polluted areas (cities, sand deserts, airports etc.) or the abundance of insects or other animals (e.g. spider webs).

Activity	Recommended Service Interval
Cleaning of rain sensor	6 month
Cleaning of dew blower	6 month
Cleaning of radiometer housing	12 month
Cleaning of microwave window	6 month
Cleaning of cooler slits	24 month
Cleaning of external sensor cage	6 month
Absolute calibration with liquid nitrogen	6 month
Inspection of cables	12 month
Exchange of microwave window	24 month

7.4 Resetting of Radiometer Embedded PC

Sometimes it is necessary to reset the internal embedded PC. This may be the case after disconnecting the radiometer from the host computer during a measurement or after transfer of a new software version. Fig.7.2 shows the location of the embedded PC interface which is protected from humidity and dust by a black plastic cover. When this cover is removed the PC's interface connectors (monitor socket, keyboard connector, disk drive connector socket and reset button) become visible. By pressing the reset button the embedded PC is rebooted. After 1 minute this initialization is finished and the user can connect the host to the

radiometer PC by clicking on  (*Connect to Radiometer*). **Do not forget to re-install the black plastic protection cover.**

The radiometer can also be reset by turning off the power and turn it on again. This will require a re-balancing of the thermal stabilisation system which requires about 5 minutes. It is therefore recommended to reset the PC by using the reset button.

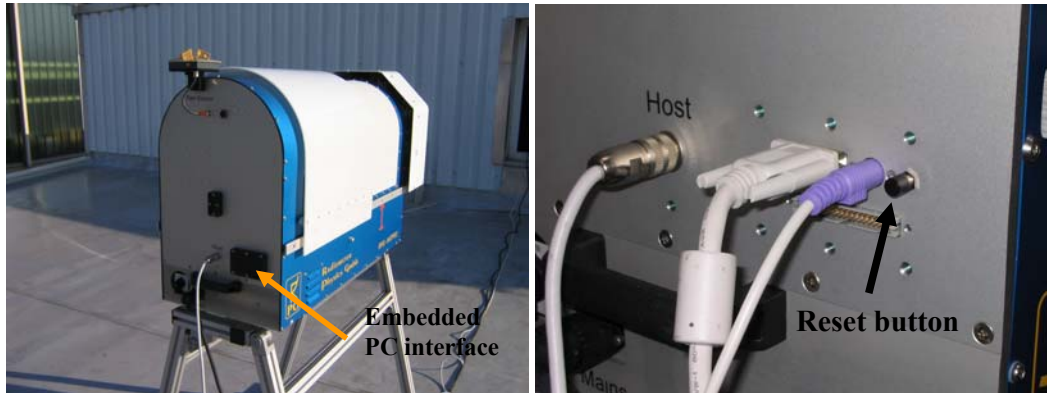







Fig.7.2: Position of radiometer PC interface.

7.5 Restarting Host

After a power failure of the host computer (with a laptop computer this occurs after about 3 hours of power failure) the host PC has to be restarted. The following steps will restart the host:

- Click  on the desktop after the host has rebooted to start the host software.
- The next step is to initiate the communication between the host and radiometer PC by pressing  (*Connect to Radiometer*). This operation takes a couple of seconds. If successful, the message *Connection to radiometer successfully established. Baud Rate adjusted.* is displayed. Otherwise the message *Radiometer does not respond! Connection could not be established...* appears. In this case try the following to handle the problem:
 - Repeat the  command.
 - If not successful, check the data cable (is it properly connected to host and radiometer?).
 - Check that the radiometer power is turned on.
 - Repeat the turn on procedure.
 - If not successful, contact RPG.
- Send the measurement batch to the radiometer with  (*Send Measurement Batch File to Radiometer*).
- Although the batch is now stored on the radiometer's embedded PC, *2CH.EXE* remains in STANDBY mode, displayed in the status line on the bottom of the screen. By pressing  the batch process is initiated. The status line entry changes to "MEASUREMENT RUNNING...".

7.6 Instrument Viewing Range

Fig.7.3 and 7.4 show the requirements for the free viewing ranges. When sky-dip (tip curve) calibration is enabled, the radiometer performs an elevation scan from zenith to 20° elevation. No obstacles should be in that viewing range to ensure a good calibration.

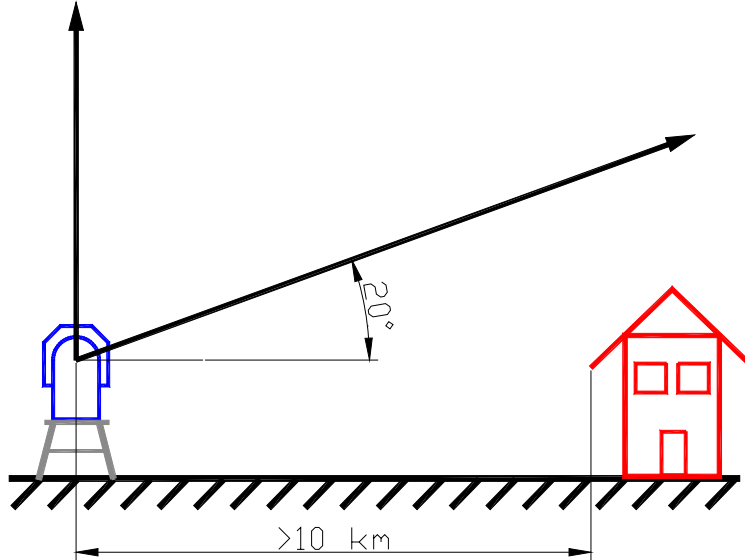

Fig.7.3: Tip curve calibration viewing range.

For boundary layer temperature profiling the instrument performs an elevation scan between zenith and 5° elevation angle. No obstacles should block the beam within a distance of 1 km.

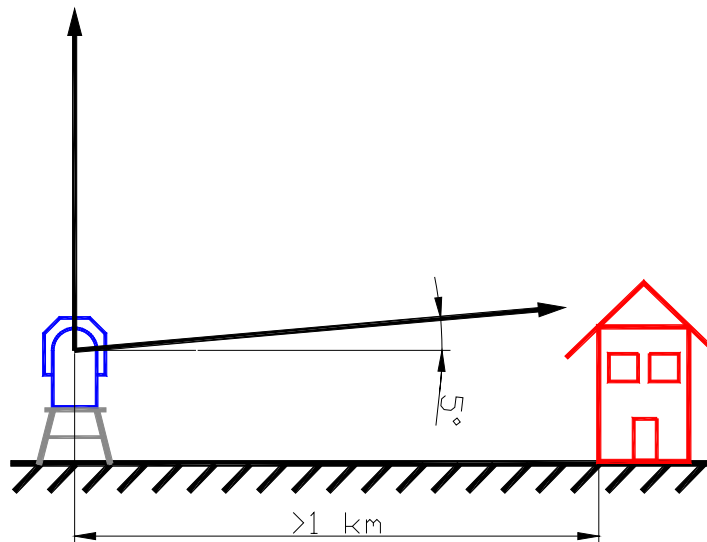

Fig.7.4: Boundary layer scan viewing range.



7.7 Upgrading System Software

Assumption: You want to install a new radiometer software version (2CH.EXE) on the embedded radiometer PC and a new version of R2CH.EXE on the host PC.

1. Step: Save the old software versions

a) Create a directory to save the old software versions (e.g. C:\MyPath\RPG-HATPRO\SAVE).

b) Connect the host to the radiometer and enter the File Transfer Menu (Fig.7.5). On the right side (Host) browse to the directory for saving the files (e.g. C:\MyPath\RPG-HATPRO\SAVE) and on the left side (Radiometer) in the System Files Directory mark the 2CH.EXE file. Then press the '>>' button to initiate the copy process.

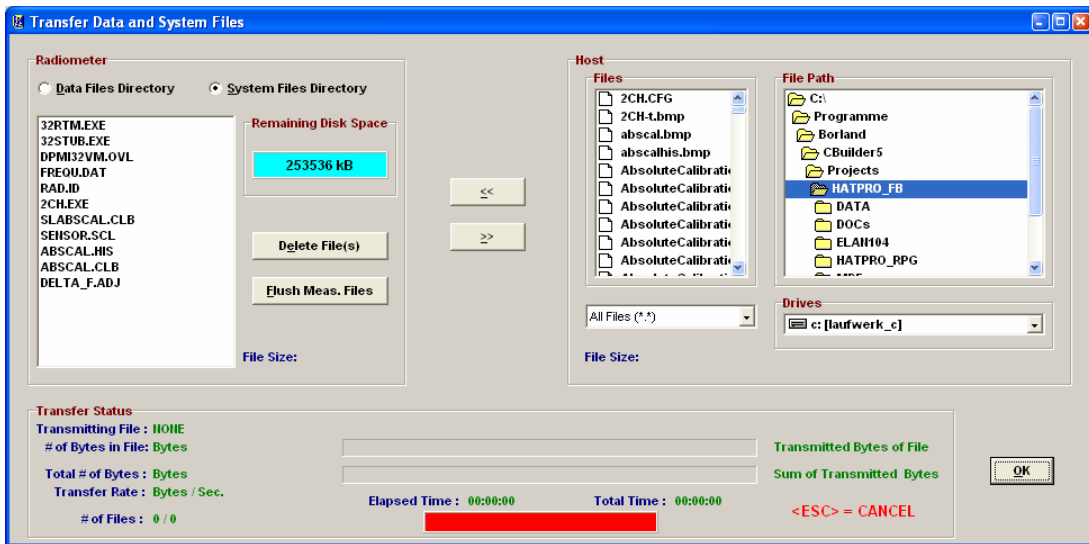

Fig.7.5: File Transfer Menu

c) locate the R2CH.EXE file in the MyPath\RPG-HATPRO directory and copy this file to the C:\MyPath\RPG-HATPRO\SAVE directory (by using the Operating System Explorer).

2. Step: Remove all measurement data files from the flash disk by clicking **Flush Meas. Files**. This purges all files that have been stored on the radiometer PC's file backup system. If you want to save these files to the host PC, first click **Data Files Directory** and transfer the files to the host. Then purge all files by the procedure described above.

3. Step: Deactivate recovery mode: enter the **Manual Radiometer Control** menu (Fig.7.6) and click on the 'Radiometer System' tag. Press the **Clear Recovery Mode** button. This disables the automatic processing of MDFs after power failure or radiometer reset.



4. Step: Overwrite the old versions by the new ones



- a) Copy the new version of 2CH.EXE (the radiometer PC software) on an arbitrary directory on your hard disk (e.g. MyPath\RPG-HATPRO\Radiometer PC). Then enter the file transfer menu in Fig.7.5 and browse to that directory. Mark the 2CH.EXE file in the Files-list and press the “<<” button. Because you are now going to overwrite a file in the System Files Directory (which is password protected for write access) a password entry window pops up. Please enter the following password in exactly the way as it is printed here:

theringsofsaturn

Press OK and the 2CH.EXE on the radiometer PC will be overwritten by the new 2CH.EXE version. Exit the File Transfer Menu after that.

- b) Boot the radiometer PC to make the new 2CH.EXE the running version. You can do this by entering the Manual Control Menu () and selecting the “Dew Blower + System” tag. Press the “Reset Radiometer PC” button and confirm the command with YES. Wait for about 2 minutes to give the boot process time enough to finish. Then reconnect to the radiometer (). The Radiometer Status box now indicates the new radiometer software version.
- c) Terminate R2CH.EXE and overwrite the old R2CH.EXE in MyPath\RPG-HATPRO with the new version.
- d) Execute R2CH.EXE to start the new host version and reconnect to the radiometer with .

The software upgrade is finished. You can confirm the successful upgrade by reading the software version numbers of both, the embedded radiometer PC (see main window radiometer status display) and the host PC (see main window caption).

7.8 Changing the Microwave Window

RPG-HATPRO radiometers built after February 2007 offer an easy way to exchange the microwave window from outside without the need to remove the cover as can be seen from Fig.7.6. The window material is a rubber foam with high transparency for microwave frequencies. The window is a perforated sheet that fits precisely into the frame structure visible in Fig.7.6. It is fixed to the radiometer frame by four stainless steel ribbons (Fig.7.8).



Fig.7.6: Radiometer with removed microwave window.

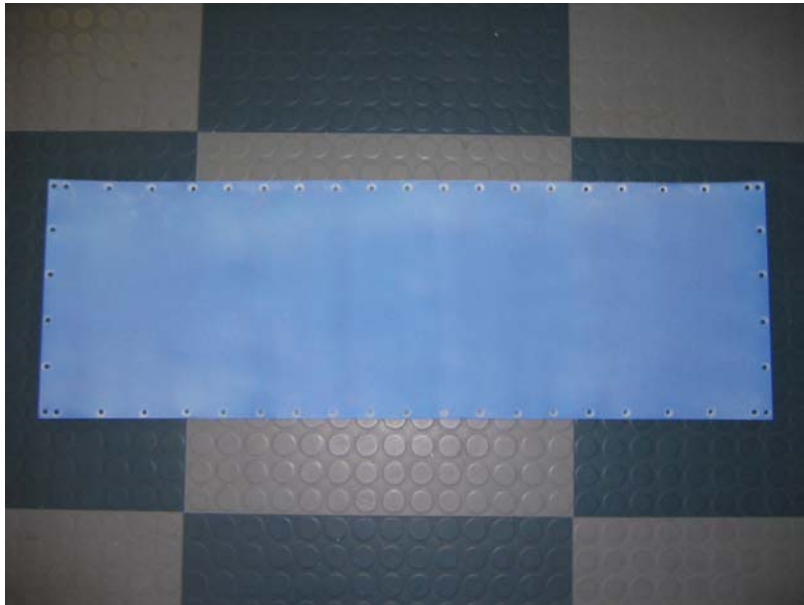

Fig.7.7: Replacement microwave window sheet.

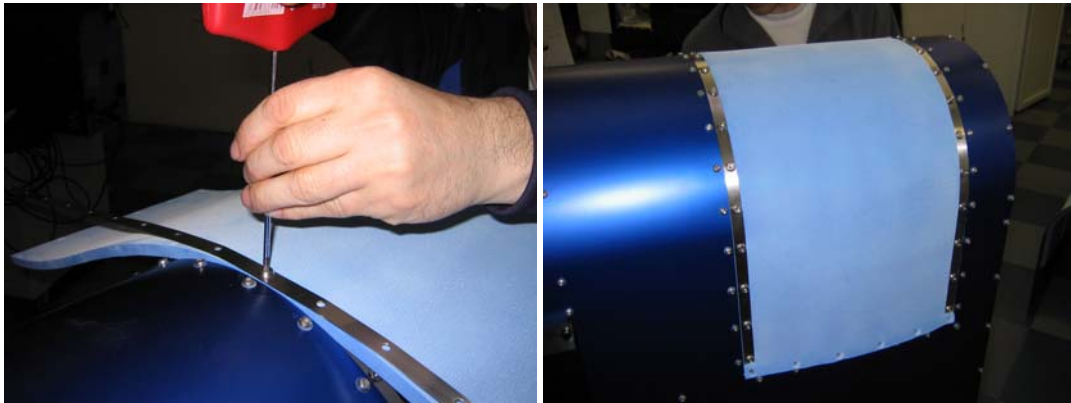
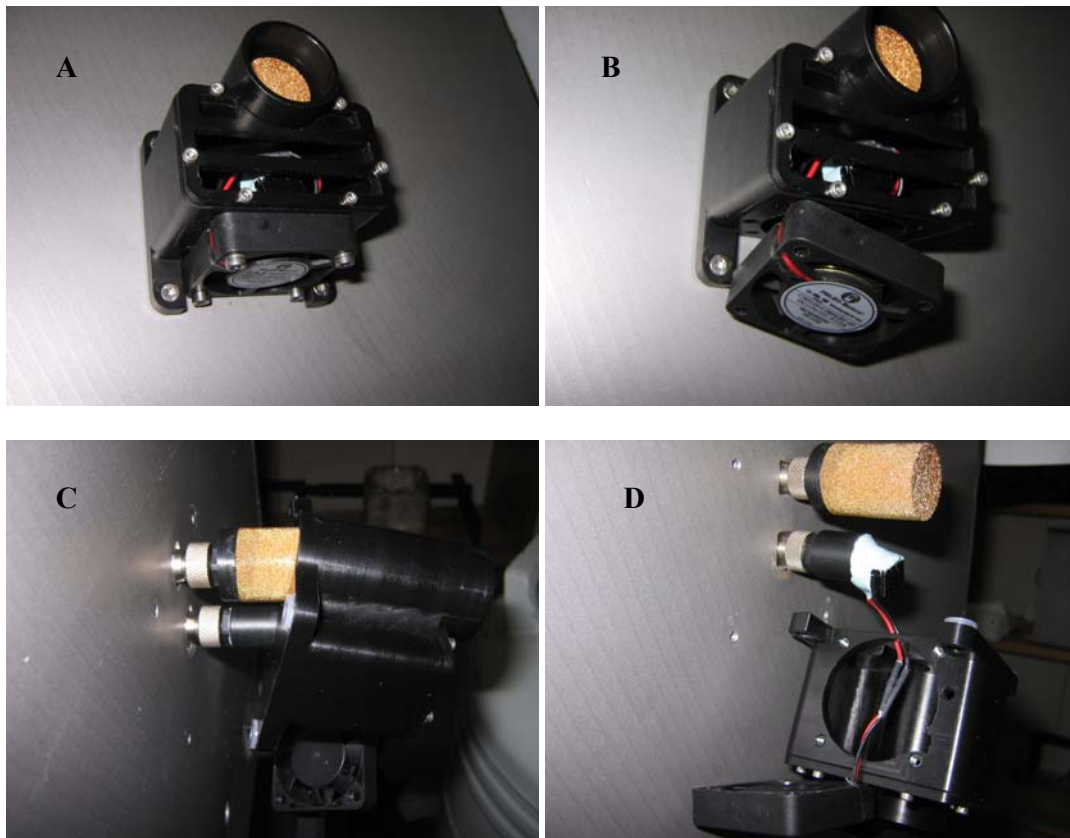

Fig.7.8: Mounting the microwave window with stainless steel ribbons to the radiometer frame structure. The window material is thermally insulating and acts as a seal for water and humidity. No additional sealing lubricant is required.

7.9 Replacing the External Surface Sensors

The external relative humidity and temperature sensors are field replaceable. In the following the process of how to exchange these sensors is described.



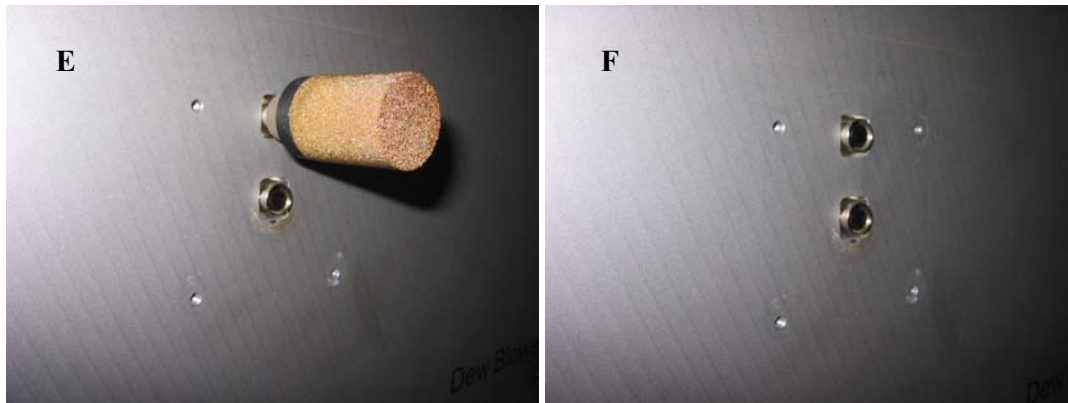

Fig.7.8A-F: Dismounting the external surface sensors: A) Sensor cage below the dew blower. B) Unscrewing the T-sensor fan. C) Unscrewing the sensor cage housing. D) The humidity sensor (with gold plated cap) and the temp. sensor can be unscrewed by hand. E) Temp. sensor removed. F) Humidity sensor removed.

Fig.7.8A-F describes how to take off the sensor cage and sensors. The replacement temperature sensor comes together with the sensor fan connected to it.

8. Mounting of Accessories and Optional Hardware

8.1 Infrared Radiometer

The infrared radiometer data is used as an additional information for retrievals dealing with cloud base height, humidity profiling, LWP etc. In order to protect the IR optics the system is operated in a tilted position (see Fig.8.9). The IR beam is reflected by a gold plated mirror to zenith direction. The IR viewing direction can be changed in a range 0°-90°.

This is useful when the IR data shall be combined with microwave observations under elevation angles other than zenith.

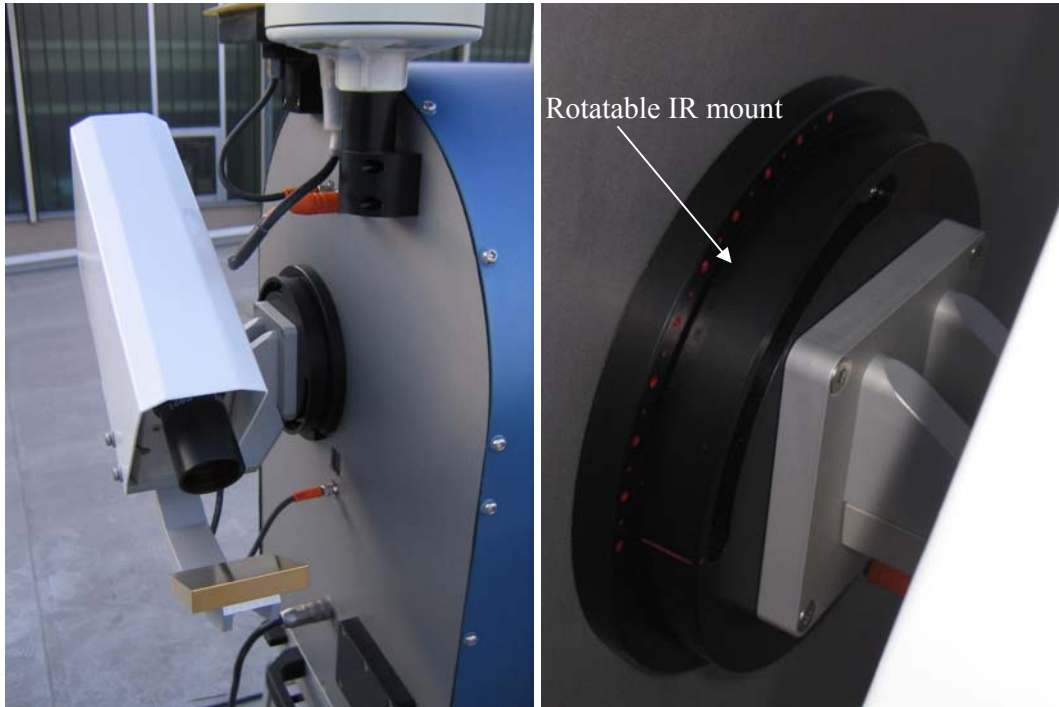

Fig.8.9: Infrared radiometer mounted to the radiometer side wall. Due to an axial mount the radiometer viewing angle can be changed between 0° and 90°.

8.2 Fiber Optics Data Cable (Upgrade Version)

If you are going to upgrade the copper wire data cable to a fiber optics data cable, turn off the radiometer power and perform the following steps:

Step 1: Remove the black plastic cover from the radiometer PC interface.

Step 2: Mount the converter A to the radiometer housing (see Fig.8.10, Fig.8.11 and Fig.8.12).

Step 3: Mount the fiber optics cable to converter A (see Fig.13).

Step 4: Connect the 6 fiber lines to the sockets on converter A. Use the cable numbering indicated on each line and match it to the numbering indicated on converter A (see Fig.14).

Step5: Mount the lid onto converter A (see Fig.15).

Step 6: On the host PC side, plug the 5 Volt supply (see Fig.8.16) into a power socket (110-220 Volt / AC) and connect the RS-232 plug into the Host PC's RS-232 interface socket. Then turn on the radiometer power and wait for a minute to let the radiometer PC boot up. Then connect to the radiometer PC from the Host PC software. You can run the radiometer data connection with maximum speed now (115.200 Baud). Maximum fiber optics cable length: 1200 m.

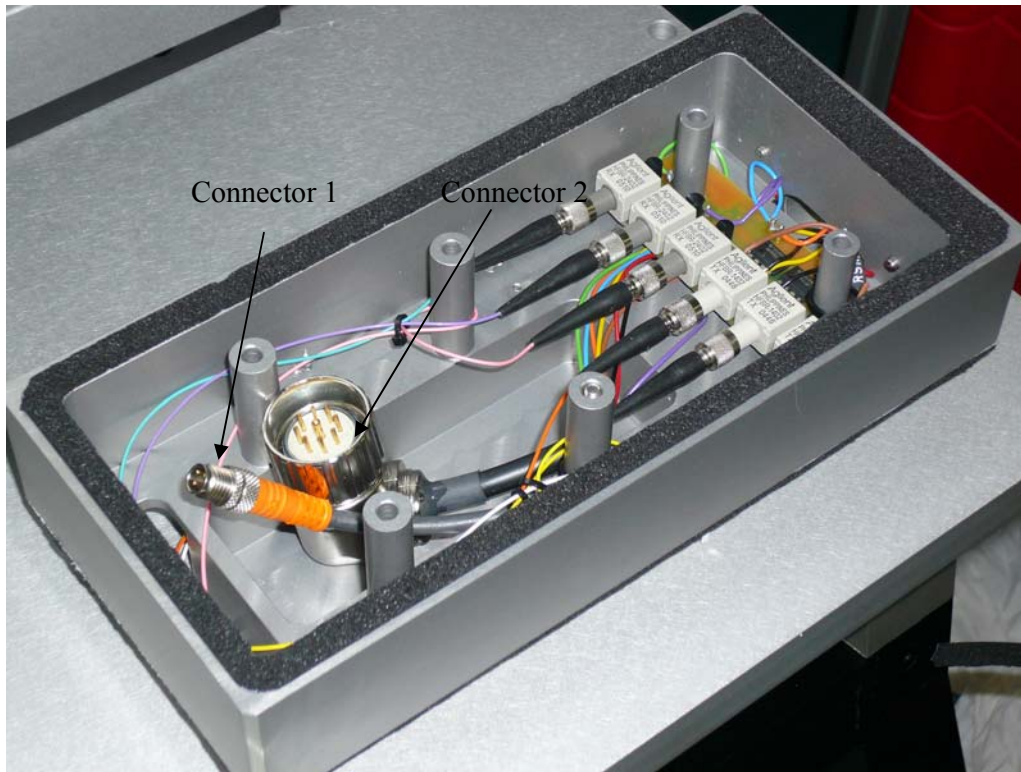

Fig.8.10: Converter A with connectors 1 and 2.



Fig.8.11: Connect converter A to radiometer.

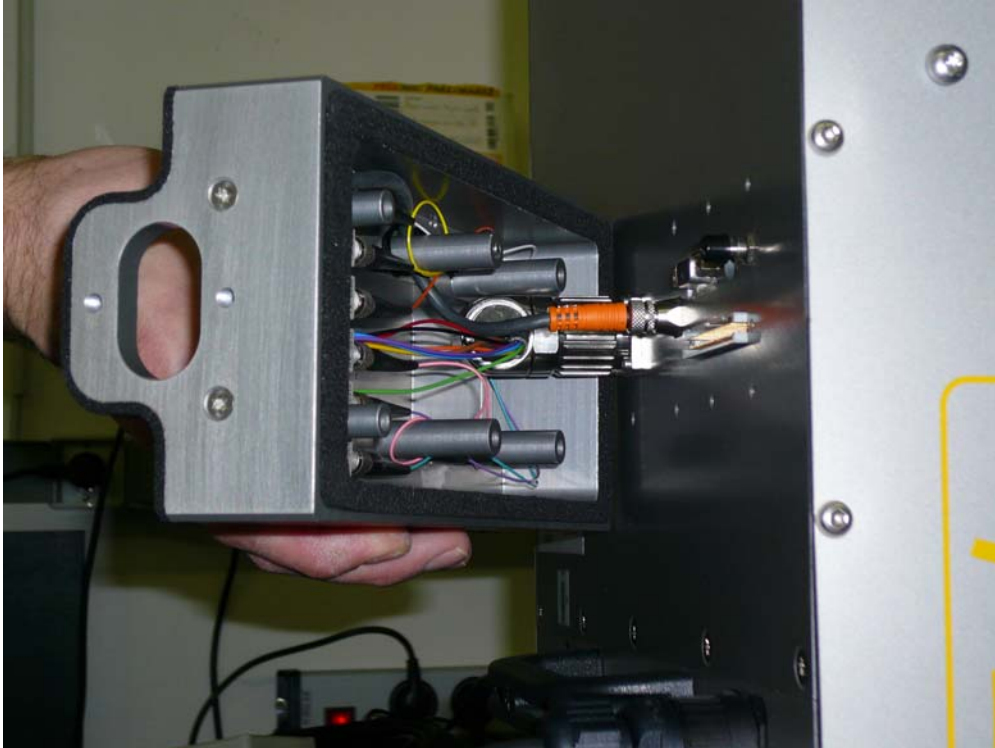

Fig.8.12a: Connect converter A to radiometer.



Fig.8.12b: Screw converter A to radiometer housing using the 50 mm screws contained in the upgrade kit.



Fig.8.13a: Fiber optics cable mount.

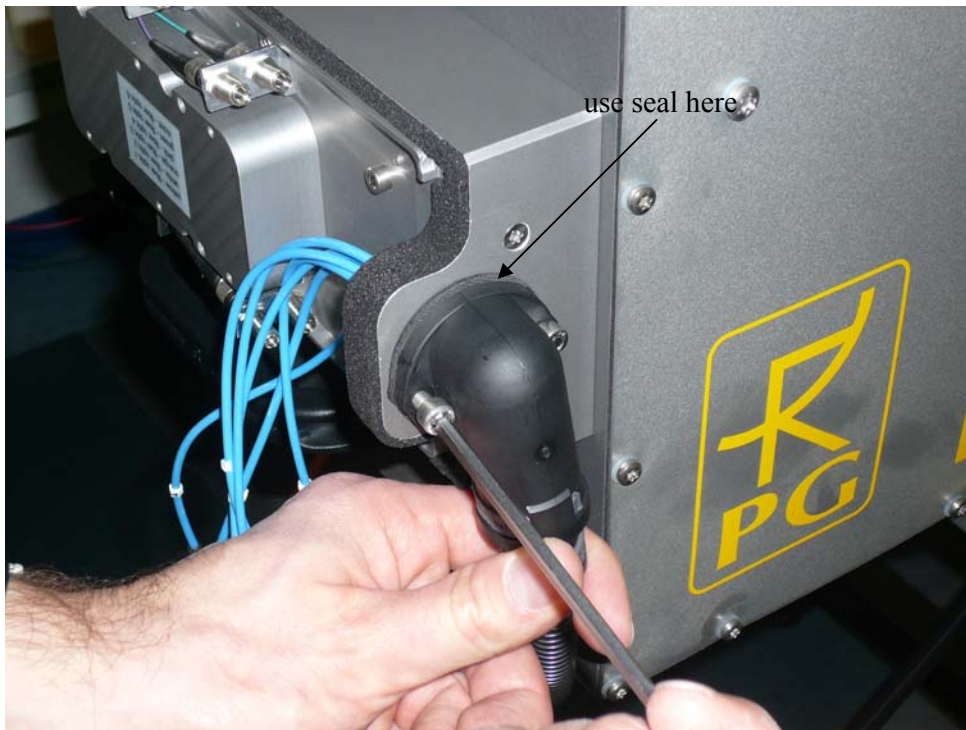

Fig.8.13b: Fiber optics cable mount.

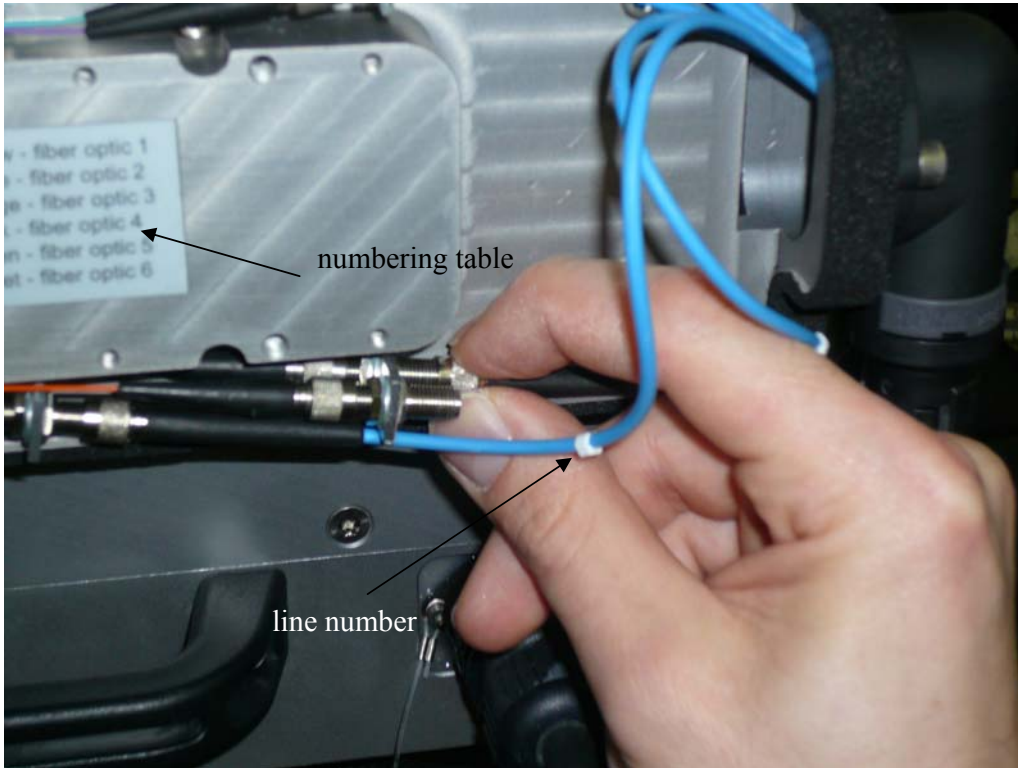

Fig.8.14a: Connecting the fibers to the converter A sockets. Use the number / color table to connect the 6 fiber lines properly.

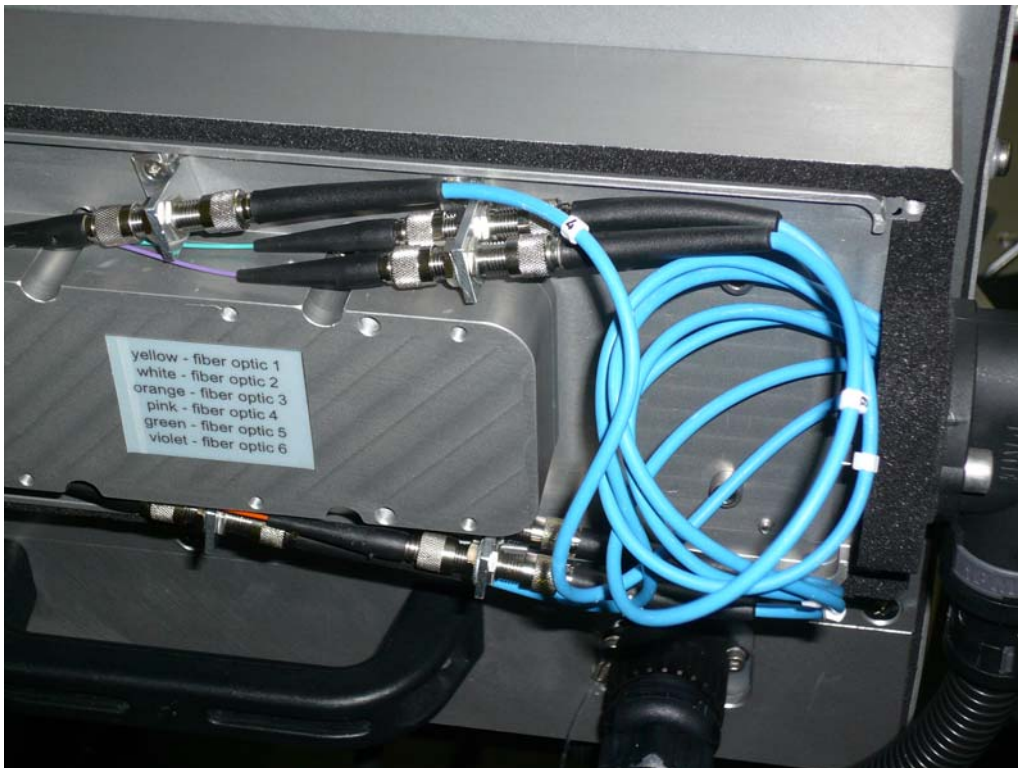

Fig.8.14b: Fiber optics cable mount completed.



Fig.8.15a: Mounting of the lid.

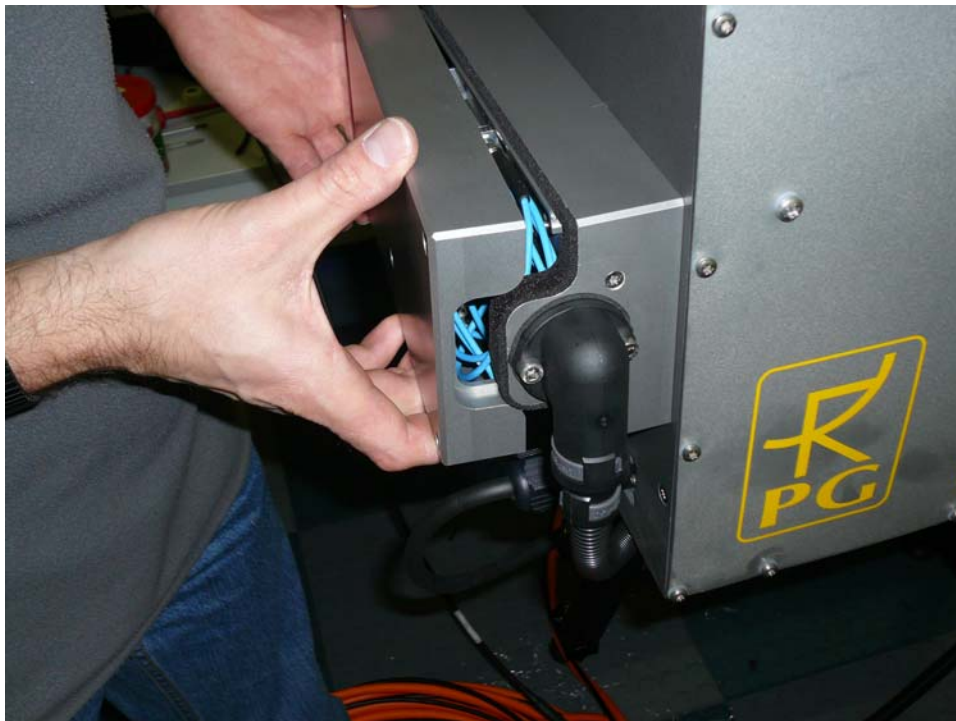

Fig.8.15b: Make sure that the seal fits properly.

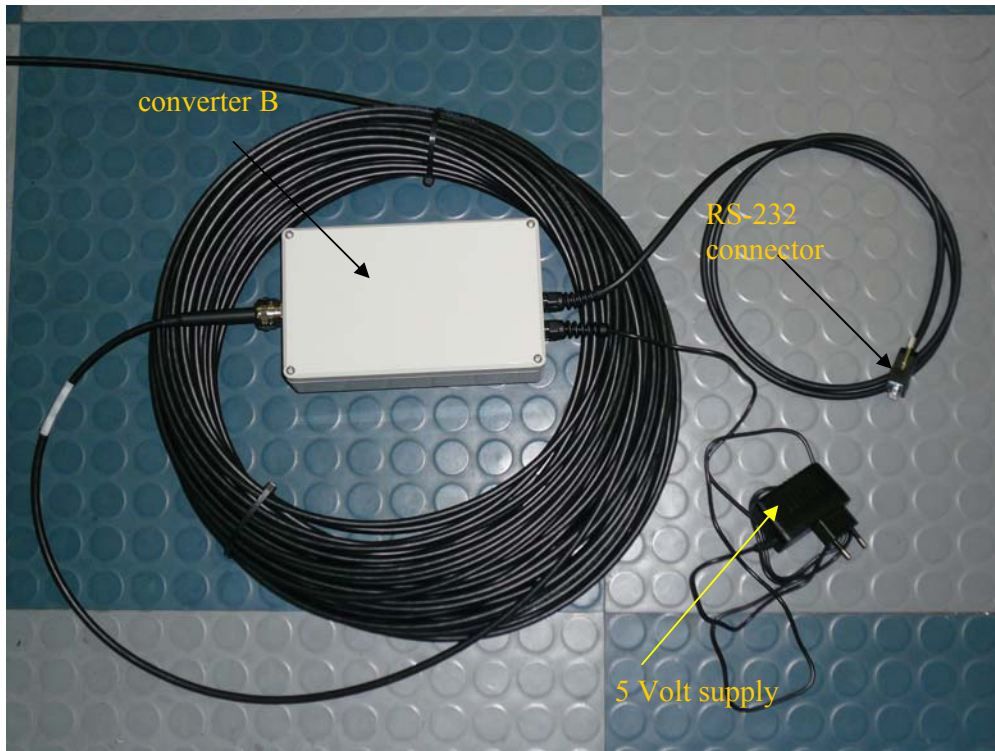

Fig.8.16: Host PC converter B and 5 Volt supply.

9. Trouble Shooting

problem	possible cause	what to do
host connection to radiometer cannot be established	A) bad cable inter-connection B) radiometer PC software has crashed C) host PC serial interface damaged D) radiometer PC serial interface damaged E) radiometer not turned on	check all connectors for cleanliness and correct fitting, data cable(s) damaged? Fiber optics cable connected correctly? reset radiometer PC (turn on/off or use reset button) replace host PC or use different serial port contact RPG turn on radiometer power and wait one minute for booting
message "The specified port in 'R2CH.CFG' has no data cable connected to it"	the host serial port specified in the configuration file exists, but the data cable is not connected to it	connect the data cable to the right host PC serial interface or change the serial port number for the connection to the radiometer (see section 5.2)
measured LWP and IWV values unrealistically high	wet radome (microwave window)	dry radome, eventually renew hydrophobic coating or replace window set lower humidity threshold for



		heater module switching (section 5.9.5)
interference (RFI) on one of the reception channels	external high frequency source (e.g. radar, data link, etc.)	use retrievals for level 2 data that are not including the disturbed channel (contact RPG)
brightness temperatures show strong drift	A) receivers are not thermally stabilized B) thermal control system malfunction	wait for a warmup period of 45 minutes check receiver temperatures in diagnostics menu (see section 5.17.2), contact RPG
brightness temperatures show spikes	A) external RFI source B) external obstacle (person, bird, etc...) C) channel malfunction	remove external source or scan to different direction remove external obstacle contact RPG
message "Measurement finished" in UNLIMITED mode	A) radiometer power failure and radiometer's recovery mode is turned off B) someone manually terminated measurement	activate radiometer recovery mode (see section 5.17.4)
rain flag always on or off	A) rain sensor malfunction B) dirty rain sensor	replace rain sensor (contact RPG) cleaning of rain sensor
surface temperature sensor shows unrealistic temperature	sensor malfunction	replace temperature sensor (field replaceable)
surface humidity sensor shows unrealistic readings	sensor calibration parameters not correct	contact RPG for sending new SENSOR.SCL file for installation on radiometer PC
damaged microwave window	birds, ice, vandalism...	replace microwave window (ask RPG for replacement window sheets)
blower always on high speed	humidity threshold for blower high speed and activated heater module too low	increase rel. humidity threshold (see section 5.9.5)
blower does not move	A) blower not correctly connected to radiometer B) radiometer power off C) blower malfunction	check blower connecting cable turn on radiometer power contact RPG
sky tipping always fails	A) clear sky conditions, inhomogeneous humidity field B) RFI in one of the transparent channels	wait for better atmospheric tipping conditions try other azimuth angles for the elevation tipping, delete the elevation angle (where the disturbance occurs) from tipping list (see section 5.9.1)
message "No response to cold load" after absolute	A) no liquid nitrogen in external target or no target	install external cold target and fill with liquid nitrogen. Repeat



calibration	attached to radiometer box B) one of the receiver channels has failed	calibration check channel responses in diagnostics menu (see section 5.17.2), contact RPG
message “No response to noise diode” after absolute calibration	A) one of the channels has low signal level B) the noise diode of one of the calibrated receivers has failed	check channel responses in diagnostics menu (see section 5.17.2), turn on/off noise diode manually, contact RPG contact RPG



Appendix A (File Formats)

A1: LWP-Files (*.LWP), Liquid Water Path

Variable Name	Type	# Bytes	Description
LWPCode	int	4	LWP-File Code (=934501978)
N	int	4	Number of recorded samples
LWPMin	float	4	Minimum of recorded LWP values
LWPMax	float	4	Maximum of recorded LWP values
LWPTimeRef	int	4	Time reference (1: UTC, 0: Local Time)
LWPRetrieval	int	4	0: lin. Reg., 1 : quad. Reg., 2: Neur. Net.
T_1	int	4	Time of sample 1 (# of sec. since 1.1.2001)
RF_1	char	1	Rainflag of sample 1 (0: no rain, 1: rain)
LWP_1	float	4	LWP sample 1 [g/m ²]
LWPAng_1 ⁽¹⁾	float	4	LWP angle 1 [DEG]
...
...
...
T_N	int	4	Time of sample N (# of sec. since 1.1.2001)
RF_N	char	1	Rainflag of sample N (0: no rain, 1: rain)
LWP_N	float	4	LWP sample N [g/m ²]
LWPAng_N ⁽¹⁾	float	4	LWP angle N [DEG]

⁽¹⁾ Angle is coded in the following way: ANG=sign(Elevation) * (|Elevation|+1000*Azimuth)

A2: IWV-Files (*.IWV), Integrated Water Vapour

Variable Name	Type	# Bytes	Description
IWVCode	int	4	IWV-File Code (=594811068)
N	int	4	Number of recorded samples
IWVMin	float	4	Minimum of recorded IWV values
IWVMax	float	4	Maximum of recorded IWV values
IWVTimeRef	int	4	Time reference (1: UTC, 0: Local Time)
IWVRetrieval	int	4	0: lin. Reg., 1 : quad. Reg., 2: Neur. Net.
T_1	int	4	Time of sample 1 (# of sec. since 1.1.2001)
RF_1	char	1	Rainflag of sample 1 (0: no rain, 1: rain)
IWV_1	float	4	IWVsample 1 [kg/m ²]
IWVAng_1 ⁽¹⁾	float	4	IWV angle 1 [DEG]
...
...
...
T_N	int	4	Time of sample N (# of sec. since 1.1.2001)
RF_N	char	1	Rainflag of sample N (0: no rain, 1: rain)
IWV_N	float	4	IWV sample N [kg/m ²]
IWVAng_N ⁽¹⁾	float	4	IWV angle N [DEG]

⁽¹⁾ Angle is coded in the following way: ANG=sign(Elevation) * (|Elevation|+1000*Azimuth)



A3: ATN-Files (*.ATN), Atmospheric Attenuation

Variable Name	Type	# Bytes	Description
ATNCode	int	4	ATN-File Code (=7757564)
N	int	4	Number of recorded samples
ATNTimeRef	int	4	Time reference (1: UTC, 0: Local Time)
ATNRetrieval	int	4	0: lin. Reg., 1 : quad. Reg., 2: Neur. Net., 3: Tmr based retrieval
FreqAnz	int	4	# of recorded frequencies
Freqs[i]	float	4 x FreqAnz	Frequencies [GHz]
ATNMin[]	float	4 x FreqAnz	Minimum of recorded ATN values
ATNMax[]	float	4 x FreqAnz	Maximum of recorded ATN values
T_1	int	4	Time of sample 1 (# of sec. since 1.1.2001)
RF_1	char	1	Rainflag of sample 1 (0: no rain, 1: rain)
ATN_1[]	float	4 x FreqAnz	ATN sample 1 (Attenuation [dB])
ANG1 ⁽¹⁾	float	4	Observation angles, sample 1
...
...
...
T_N	int	4	Time of sample N (# of sec. since 1.1.2001)
RF_N	char	1	Rainflag of sample N (0: no rain, 1: rain)
ATN_N[]	float	4 x FreqAnz	ATN sample N (Attenuation [dB])
ANGN ⁽¹⁾	float	4	Observation angles, sample N

⁽¹⁾ Angle is coded in the following way: ANG=sign(Elevation) * (|Elevation|+1000*Azimuth)

A4: BRT-Files (*.BRT), Brightness Temperature

Variable Name	Type	# Bytes	Description
BRTCode	int	4	BRT-File Code (=666666)
N	int	4	Number of recorded samples
BRTTimeRef	int	4	Time reference (1: UTC, 0: Local Time)
FreqAnz	int	4	# of recorded frequencies
Freq[]	float	4 x FreqAnz	Frequencies [GHz]
BRTMin[]	float	4 x FreqAnz	Minimum array of recorded BRT values
BRTMax[]	float	4 x FreqAnz	Maximum array of recorded BRT values
T_1	int	4	Time of sample 1 (# of sec. since 1.1.2001)
RF_1	char	1	Rainflag of sample 1 (0: no rain, 1: rain)
BRT_1[]	float	4 x FreqAnz	Br. Temp. array sample 1 [K]
ANG_1 ⁽¹⁾	float	4	Elevation/Azimuth angle of sample 1 (DEG)
...
T_N	int	4	Time of sample N (# of sec. since 1.1.2001)
RF_N	char	1	Rainflag of sample N (0: no rain, 1: rain)



BRT_N[]	float	4 x FreqAnz	Br. Temp. sample N, frequency 1 [K]
ANG N ⁽¹⁾	float	4	Elevation/Azimuth angle of sample N (DEG)

⁽¹⁾ Angle is coded in the following way: ANG=sign(Elevation) * (|Elevation|+1000*Azimuth)

A5: MET-Files (*.MET), Meteorological Sensors

Variable Name	Type	# Bytes	Description
METCode	int	4	MET-File Code (=599658943)
N	int	4	Number of recorded samples
METMinP	float	4	Minimum of recorded pressure values
METMaxP	float	4	Maximum of recorded pressure values
METMinT	float	4	Minimum of environmental temp. values
METMaxT	float	4	Maximum of environmental temp. values
METMinH	float	4	Minimum of recorded rel. humidity values
METMaxH	float	4	Maximum of recorded rel. humidity values
METTimeRef	int	4	Time reference (1: UTC, 0: Local Time)
T 1	int	4	Time of sample 1 (# of sec. since 1.1.2001)
RF 1	char	1	Rainflag of sample 1 (0: no rain, 1: rain)
MET 1(0)	float	4	Pressure value sample 1 [mbar]
MET 1(1)	float	4	Temp. value sample 1 [K]
MET 1(2)	float	4	Rel. humidity value sample 1 [%]
...
MET N(0)	float	4	Pressure value sample N [mbar]
MET N(1)	float	4	Temp. value sample N [K]
MET N(2)	float	4	Rel. humidity value sample N [%]

A6: OLC-Files (*.OLC), Oxygen Line Chart

Variable Name	Type	# Bytes	Description
OLCCode	int	4	OLC-File Code (=955874342)
N	int	4	Number of recorded samples
OLCMin	float	4	Minimum of recorded OL-Brt. values
OLCMax	float	4	Maximum of recorded OL-Brt. values
OLCTimeRef	int	4	Time reference (1: UTC, 0: Local Time)
FreqAnz	int	4	# of recorded frequencies in oxygen line
Freq[i]	float	4 x FreqAnz	Frequencies [GHz]
T 1	int	4	Time of sample 1 (# of sec. since 1.1.2001)
RF 1	char	1	Rainflag of sample 1 (0: no rain, 1: rain)
O2 BRT 1(i)	float	4 x FreqAnz	Brightness Temp. of oxygen line [K], sample 1
ANG1 ⁽¹⁾	float	4	Observation angles, sample 1
...
T N	int	4	Time of sample N (# of sec. since 1.1.2001)
RF N	char	1	Rainflag of sample N (0: no rain, 1: rain)
O2 BRT N(i)	float	4 x FreqAnz	Brightness Temp. of oxygen line [K], sample N
ANGN ⁽¹⁾	float	4	Observation angles, sample N

⁽¹⁾ Angle is coded in the following way: ANG=sign(Elevation) * (|Elevation|+1000*Azimuth)



A7: TPC-Files (*.TPC), Temperature Profile Chart (Full Trop.)

Variable Name	Type	# Bytes	Description
TPCCode	int	4	TPC-File Code (=780798065)
N	int	4	Number of recorded samples
TPCMin	float	4	Minimum of recorded temperature values
TPCMax	float	4	Maximum of recorded temperature values
TPCTimeRef	int	4	Time reference (1: UTC, 0: Local Time)
TPCRetrieval	int	4	0: lin. Reg., 1 : quad. Reg., 2: Neural Network
AltAnz	int	4	# of altitude layers
Alts[i]	int	4 x AltAnz	Altitudes [m]
T_1	int	4	Time of sample 1 (# of sec. since 1.1.2001)
RF_1	char	1	Rainflag of sample 1 (0: no rain, 1: rain)
TP_1(i)	float	4 x AltAnz	Temperature Profile [K], sample 1
...
T_N	int	4	Time of sample N (# of sec. since 1.1.2001)
RF_N	char	1	Rainflag of sample N (0: no rain, 1: rain)
TP_N(i)	float	4 x AltAnz	Temperature Profile [K], sample N

A8: TPB-Files (*.TPB), Temperature Profile Chart (Boundary Layer)

Variable Name	Type	# Bytes	Description
TPBCode	int	4	TPB-File Code (=459769847)
N	int	4	Number of recorded samples
TPBMin	float	4	Minimum of recorded temperature values
TPBMax	float	4	Maximum of recorded temperature values
TPBTimeRef	int	4	Time reference (1: UTC, 0: Local Time)
TPBRetrieval	int	4	0: lin. Reg., 1 : quad. Reg., 2: Neural Network
AltAnz	int	4	# of altitude layers
Alts[i]	int	4 x AltAnz	Altitudes [m]
T_1	int	4	Time of sample 1 (# of sec. since 1.1.2001)
RF_1	char	1	Rainflag of sample 1 (0: no rain, 1: rain)
TP_1(i)	float	4 x AltAnz	Temperature Profile [K], sample 1
...
T_N	int	4	Time of sample N (# of sec. since 1.1.2001)
RF_N	char	1	Rainflag of sample N (0: no rain, 1: rain)
TP_N(i)	float	4 x AltAnz	Temperature Profile [K], sample N

A9: WVL-Files (*.WVL), Water Vapour Line Chart

Variable Name	Type	# Bytes	Description
WVLCode	int	4	WVL-File Code (=456783953)
N	int	4	Number of recorded samples
WVLMin	float	4	Minimum of recorded WVL-Brt. values
WVLMax	float	4	Maximum of recorded WVL-Brt. values
WVLTimeRef	int	4	Time reference (1: UTC, 0: Local Time)



FreqAnz	int	4	# of recorded frequencies in WV line
Freq[i]	float	4 x FreqAnz	Frequencies [GHz]
T_1	int	4	Time of sample 1 (# of sec. since 1.1.2001)
RF_1	char	1	Rainflag of sample 1 (0: no rain, 1: rain)
WVL_BRT_1(i)	float	4 x FreqAnz	Brightness Temp. of WV line [K], sample 1
ANG1 ⁽¹⁾	float	4	Observation angle, sample 1
...
T_N	int	4	Time of sample N (# of sec. since 1.1.2001)
RF_N	char	1	Rainflag of sample N (0: no rain, 1: rain)
WVL_BRT_N(i)	float	4 x FreqAnz	Brightness Temp. of WV line [K], sample N
ANGN ⁽¹⁾	float	4	Observation angle, sample N

⁽¹⁾ Angle is coded in the following way: ANG=sign(Elevation) * (|Elevation|+1000*Azimuth)

A10(1): HPC-Files (*.HPC), Humidity Profile Chart (without RH)

Variable Name	Type	# Bytes	Description
HPCCode	int	4	HPC-File Code (=117343672)
N	int	4	Number of recorded samples
HPCMin	float	4	Minimum of recorded abs. humidity values
HPCMax	float	4	Maximum of recorded abs. humidity values
HPCTimeRef	int	4	Time reference (1: UTC, 0: Local Time)
HPCRetrieval	int	4	0: lin. Reg., 1 : quad. Reg., 2: Neural Network
AltAnz	int	4	# of altitude layers
Alts[i]	int	4 x AltAnz	Altitudes [m]
T_1	int	4	Time of sample 1 (# of sec. since 1.1.2001)
RF_1	char	1	Rainflag of sample 1 (0: no rain, 1: rain)
HP_1(i)	float	4 x AltAnz	Humidity Profile [g/m ³], sample 1
...
T_N	int	4	Time of sample N (# of sec. since 1.1.2001)
RF_N	char	1	Rainflag of sample N (0: no rain, 1: rain)
HP_N(i)	float	4 x AltAnz	Humidity Profile [g/m ³], sample N

A10(2): HPC-Files (*.HPC), Humidity Profile Chart (including RH)

Variable Name	Type	# Bytes	Description
HPCCode	int	4	HPC-File Code (=117343673)
N	int	4	Number of recorded samples
HPCMin	float	4	Minimum of recorded abs. humidity values
HPCMax	float	4	Maximum of recorded abs. humidity values
HPCTimeRef	int	4	Time reference (1: UTC, 0: Local Time)
HPCRetrieval	int	4	0: lin. Reg., 1 : quad. Reg., 2: Neural Network
AltAnz	int	4	# of altitude layers
Alts[i]	int	4 x AltAnz	Altitudes [m]
T_1	int	4	Time of sample 1 (# of sec. since 1.1.2001)
RF_1	char	1	Rainflag of sample 1 (0: no rain, 1: rain)
HP_1(i)	float	4 x AltAnz	Abs. Humidity Profile [g/m ³], sample 1



...
T_N	int	4	Time of sample N (# of sec. since 1.1.2001)
RF_N	char	1	Rainflag of sample N (0: no rain, 1: rain)
HP_N(i)	float	4 x AltAnz	Abs. Humidity Profile [g/m ³], sample N
RHMin	float	4	Minimum of recorded rel. humidity values [%]
RHMax	float	4	Maximum of recorded rel. humidity values [%]
T_1	int	4	Time of sample 1 (# of sec. since 1.1.2001)
RF_1	char	1	Rainflag of sample 1 (0: no rain, 1: rain)
HP_1(i)	float	4 x AltAnz	Rel. Humidity Profile [%], sample 1
...
T_N	int	4	Time of sample N (# of sec. since 1.1.2001)
RF_N	char	1	Rainflag of sample N (0: no rain, 1: rain)
HP_N(i)	float	4 x AltAnz	Abs. Humidity Profile [%], sample N

A11: LPR-Files (*.LPR), Liquid Water Profile Chart

Variable Name	Type	# Bytes	Description
LPRCode	int	4	LPR-File Code (=4567)
N	int	4	Number of recorded samples
LPRMin	float	4	Minimum of recorded LW-density
LPRMax	float	4	Maximum of recorded LW-density
LPRTimeRef	int	4	Time reference (1: UTC, 0: Local Time)
LPRRetrieval	int	4	0: lin. Reg., 1 : quad. Reg., 2: Neural Network
AltAnz	int	4	# of altitude layers
Alts[i]	int	4 x AltAnz	Altitudes [m]
T_1	int	4	Time of sample 1 (# of sec. since 1.1.2001)
RF_1	char	1	Rainflag of sample 1 (0: no rain, 1: rain)
LWD_1(i)	float	4 x AltAnz	LW-density profile [g/m ³], sample 1
...
T_N	int	4	Time of sample N (# of sec. since 1.1.2001)
RF_N	char	1	Rainflag of sample N (0: no rain, 1: rain)
LWD_N(i)	float	4 x AltAnz	LW-density profile [g/m ³], sample N

A12: IRT-Files (*.IRT), Infrared Radiometer Temperatures

Variable Name	Type	# Bytes	Description
IRTCode	int	4	IRT-File Code (=671112495)
N	int	4	Number of recorded samples
IRTMin	float	4	Minimum of recorded IRT values
IRTMax	float	4	Maximum of recorded IRT values
IRTTimeRef	int	4	Time reference (1: UTC, 0: Local Time)
T_1	int	4	Time of sample 1 (# of sec. since 1.1.2001)
RF_1	char	1	Rainflag of sample 1 (0: no rain, 1: rain)
IRT_1	float	4	Infrared temperature [K], sample 1
...
T_N	int	4	Time of sample N (# of sec. since 1.1.2001)



RF_N	char	1	Rainflag of sample N (0: no rain, 1: rain)
IRT_N	float	4	Infrared temperature [K], sample N

A13: BLB-Files (*.BLB), Boundary Layer BT Profiles

Variable Name	Type	# Bytes	Description
BLBCode	int	4	BLB-File Code (=567845847)
N	int	4	Number of recorded samples
BLBMin[]	float	14*4	Minimum of recorded BLB values (14 channels, 22.24-31.4, 51.3-58)
BLBMax[]	float	14*4	Maximum of recorded BLB values (14 channels, 22.24-31.4, 51.3-58)
BLBTimeRef	int	4	Time reference (1: UTC, 0: Local Time)
Nf	int	4	No. of frequencies (14)
Freq[]	float	Nf*4	Frequencies [GHz]
Nang	int	4	No. of scanning angles (without 0°)
Ang[] ⁽¹⁾	float	Nang*4	Scanning angles [DEG], without 0°
T_1	int	4	Time of sample 1 (# of sec. since 1.1.2001)
RF/Mode_1	char	1	Rainflag/Mode of sample 1. Bit1=0: no rain, Bit1=1: rain; Bit2/3=0/0: 1 st Quadrant Scan, Bit2/3=1/0:2 nd Quadrant Scan, Bit2/3=0/1: Averaged Two Quadrant Scan
BT1_1[]	float	(Nang+1)*4	BTs for channel 1 (22.4 GHz) at different angles (starting with zenith), sample 1, the temperature at 0° is added to each scan (surface sensor)
...
BT14_1[]	float	(Nang+1)*4	BTs for channel 14 (58 GHz) at different angles (starting with zenith), sample 1, the temperature at 0° is added to each scan (surface sensor)
...
T_N	int	4	Time of sample N (# of sec. since 1.1.2001)
RF/Mode_N	char	1	Rainflag/Mode of sample N. Bit1=0: no rain, Bit1=1: rain; Bit2/3=0/0: 1 st Quadrant Scan, Bit2/3=1/0:2 nd Quadrant Scan, Bit2/3=0/1: Averaged Two Quadrant Scan
BT1_N[]	float	(Nang+1)*4	BTs for channel 1 (22.4 GHz) at different angles (starting with zenith), sample N, the temperature at 0° is added to each scan (surface sensor)
...
BT14_N[]	float	(Nang+1)*4	BTs for channel 14 (58 GHz) at different angles (starting with zenith), sample N, the temperature at 0° is added to each scan (surface sensor)

⁽¹⁾ Angle is coded in the following way: Ang=sign(Elevation) * (|Elevation|+1000*Azimuth)



A14: STA-Files (*.STA), Stability Indices

Variable Name	Type	# Bytes	Description
STACode	int	4	STA-File Code (=454532)
N	int	4	Number of recorded samples
STAMin[]	float	4	Minimum of recorded indices
STAMax[]	float	4	Maximum of recorded indices
STAIndexList	int	6*4	Flag for each index (1: Index present in file, 0: Index not present in file). Sequence: LI, KO, TTI, KI, SI, CAPE
STATimeRef	int	4	Time reference (1: UTC, 0: Local Time)
T_1	int	4	Time of sample 1 (# of sec. since 1.1.2001)
RF_1	char	1	Rainflag of sample 1 (0: no rain, 1: rain)
STA1_1	float	4	LI-sample 1 (if STAIndexList[0]=1)
...
STA1_6	float	4	CAPE-sample 1 (if STAIndexList[5]=1)
...
T_N	int	4	Time of sample N (# of sec. since 1.1.2001)
RF_N	char	1	Rainflag of sample N (0: no rain, 1: rain)
STAN_1	float	4	LI-sample N (if STAIndexList[0]=1)
...
STAN_6	float	4	CAPE-sample N (if STAIndexList[5]=1)

A15: Structure of Calibration Log-File (CAL.LOG)

Variable Name	Type	# Bytes	Description
STACode	int	4	CAL.LOG -File Code (=657643)
N_Gain	int	4	Number of recorded gain cal. samples
N_Noise	int	4	Number of recorded noise cal. samples
N_SkyTip	int	4	Number of recorded tip curve cal. samples
N_CH_Rec1	int	4	Number of receiver 1 channels
N_CH_Rec2	int	4	Number of receiver 2 channels
Frequ[]	float	4* ChanNo	Frequencies of Rec1 and Rec2
CalType1	int	4	Type of calibration sample 1 (0=gain, 1=noise, 2=tip curve results, 3=tip curve with full fit information)
CalTime1	int	4	Time of sample 1 (# of sec. since 1.1.2001)
TipCurveStat1	int	4	Status of tip curve calibration (only if CalType1=2 or 3), 3 = FAILED, 2 = SUCCESS
Gain1[]	float	4* ChanNo	Gains of calibration sample 1
Tsys1[]	float	4* ChanNo	system noise temps of calibration sample 1 (only if CalType1=1 or



			CalType1=2 or CalType1=3)
LinCorr1[]	float	4* ChanNo	Linear correlations for calibration sample 1 (only if CalType1=2 or 3)
ChiSqr1[]	float	4* ChanNo	Chi square factors for calibration sample 1 (only if CalType1=2 or 3)
NoiseTemp1[]	float	4* ChanNo	Noise source temperatures for calibration sample 1 (only if CalType1=2 or 3)
SkyTipAngAnz1	int	4	Number of sky tip for calibration sample 1 (only if CalType1= 3)
Airmass1[]	float	4* SkyTipAngAnz1	Airmass array (only if CalType1=3)
SkyDipUs1[i][j] i=0, ..., N_CH_Rec1-1 j=0, ..., SkyTipAngAnz1	float	4* N_CH_Rec1* (SkyTipAngAnz1+1)	Sky dip detector voltages (only if CalType1=3). For each frequency the det. Voltage is given at all angles. The last entry is the voltage on the hot target
TauSuccess1[]	int	4* N_CH_Rec1	Flag that indicates if the Tau calculation during the skydip was successful (0=no, 1=yes, 2=yes, also skydip successful) (only if CalType1=3)
TauArr1[0][j]	float	4* SkyTipAngAnz1	Tau array for channel 1 (only if CalType1=3 and TauSuccess1[0]=1)
LinFit1A[0]	float	4	Linear Fit parameter A (offset) for channel 1 (only if CalType1=3 and TauSuccess1[0]=1)
LinFit1B[0]	float	4	Linear Fit parameter B (slope) for channel 1 (only if CalType1=3 and TauSuccess1[0]=1)
...
TauArr1[N_CH_Rec1-1][j]	float	4* SkyTipAngAnz1	Tau array for last channel (only if CalType1=3 and TauSuccess1[N_CH_Rec1-1]=1)
LinFit1A[N_CH_Rec1-1]	float	4	Linear Fit parameter A (offset) for channel 1 (only if CalType1=3 and TauSuccess1[N_CH_Rec1-1]=1)
LinFit1B[N_CH_Rec1-1]	float	4	Linear Fit parameter B (slope) for last channel (only if CalType1=3 and TauSuccess1[N_CH_Rec1-1]=1)
...
CalTypeN	int	4	Type of calibration sample N (0=gain, 1=noise, 2=tip curce)
CalTimeN	int	4	Time of sample N (# of sec. since



			1.1.2001)
TipCurveStatN	int	4	Status of tip curve calibration (only if CalTypeN=2), 3=FAILED, 2=SUCCESS
GainN[]	float	4* ChanNo	Gains of calibration sample 1
TsysN[]	float	4* ChanNo	system noise temps of calibration sample N (only if CalTypeN=1 or CalTypeN=2)
LinCorrN[]	float	4* ChanNo	Linear correlations for calibration sample N (only if CalTypeN=2)
ChiSqrN[]	float	4* ChanNo	Chi square factors for calibration sample N (only if CalTypeN=2)
NoiseTempN[]	float	4* ChanNo	Noise source temperatures for calibration sample N (only if CalTypeN=2)
SkyTipAngAnzN	int	4	Number of sky tip for calibration sample N (only if CalType1=3)
AirmassN[]	float	4* SkyTipAngAnzN	Airmass array (only if CalType1=3)
SkyDipUsN[i][j] i=0, ... , N_CH_Rec1-1 j=0, ... , SkyTipAngAnzN	float	4* N_CH_Rec1* (SkyTipAngAnzN+1)	Sky dip detector voltages (only if CalType1=3). For each frequency the det. Voltage is given at all angles. The last entry is the voltage on the hot target, sample N
TauSuccessN[]	int	4* N_CH_Rec1	Flag that indicates if the Tau calculation during the skydip was successful (0=no, 1=yes, 2=yes, also skydip successful) (only if CalType1=3), sample N
TauArrN[0][j]	float	4* SkyTipAngAnzN	Tau array for channel 1 (only if CalType1=3 and TauSuccessN[0]=1)
LinFit1A[0]	float	4	Linear Fit parameter A (offset) for channel 1 (only if CalType1=3 and TauSuccessN[0]=1)
LinFit1B[0]	float	4	Linear Fit parameter B (slope) for channel 1 (only if CalType1=3 and TauSuccessN[0]=1)
...
TauArr1[N_CH_Rec1 - 1][j]	float	4* SkyTipAngAnzN	Tau array for last channel (only if CalType1=3 and TauSuccessN[N_CH_Rec1 - 1]=1)
LinFit1A[N_CH_Rec1 - 1]	float	4	Linear Fit parameter A (offset) for channel 1 (only if CalType1=3 and TauSuccessN[N_CH_Rec1 - 1]=1)
LinFit1B[N_CH_Rec1 - 1]	float	4	Linear Fit parameter B (slope)



1]			for last channel (only if CalType1=3 and TauSuccessN [N CH Rec1 -1] =1)
----	--	--	---

with $N = N_Gain + N_Noise + N_SkyTip$ and $ChanNo = N_CH_Rec1 + N_CH_Rec2$.

A16: CBH-Files (*.CBH), Cloud Base Height

Variable Name	Type	# Bytes	Description
CBHCode	int	4	CBH-File Code (=67777499)
N	int	4	Number of recorded samples
CBHMin	float	4	Minimum of recorded CBH values
CBHMax	float	4	Maximum of recorded CBH values
CBHTimeRef	int	4	Time reference (1: UTC, 0: Local Time)
T_1	int	4	Time of sample 1 (# of sec. since 1.1.2001)
RF_1	char	1	Rainflag of sample 1 (0: no rain, 1: rain)
CBH_1	float	4	Cloud base height [m], sample 1
...
T_N	int	4	Time of sample N (# of sec. since 1.1.2001)
RF_N	char	1	Rainflag of sample N (0: no rain, 1: rain)
CBH_N	float	4	Cloud base height [m], sample N

A17: VLT-Files (*.VLT), Channel Voltage File

Variable Name	Type	# Bytes	Description
CBHCode	int	4	VLT-File Code (=362118746)
N	int	4	Number of recorded samples
IntTimeIndex	int	4	Integration time index (0:1sec, 1:2sec, 2:5 sec, 3:10sec, 4:20sec, 5:30sec, 6:60sec)
DiagSource[0..3]	int	4x4	Type array for the four acquisition channels; 0=disabled, 1=receiver 1 voltage data, 2=receiver 2 voltage data, 3=ambient target temp., 4=env. temp, 5=rec. 1 temp., 6=rec. 2 temp., 7=bar. Pressure, 8=rel. humidity
DataSample1, DiagSource[0]	float	4 or 7x4	Data for sample 1 (7 floats in the case of data type =1/2, one float in all other cases)
DataSample1, DiagSource[1]	float	4 or 7x4	Data for sample 1 (7 floats in the case of data type =1/2, one float in all other cases)
DataSample1, DiagSource[2]	float	4 or 7x4	Data for sample 1 (7 floats in the case of data type =1/2, one float in all other cases)
DataSample1, DiagSource[3]	float	4 or 7x4	Data for sample 1 (7 floats in the case of data type =1/2, one float in all other cases)
Time1	int	4	Time in seconds after measurement start ofr sample N
...
DataSampleN, DiagSource[0]	float	4 or 7x4	Data for sample N (7 floats in the case of data type =1/2, one float in all other cases)



DataSampleN, DiagSource[1]	float	4 or 7x4	Data for sample N (7 floats in the case of data type =1/2, one float in all other cases)
DataSampleN, DiagSource[2]	float	4 or 7x4	Data for sample N (7 floats in the case of data type =1/2, one float in all other cases)
DataSampleN, DiagSource[3]	float	4 or 7x4	Data for sample N (7 floats in the case of data type =1/2, one float in all other cases)
TimeN	int	4	Time in seconds after measurement start of sample N

A18: HKD-Files (*.HKD), Housekeeping Data File

Variable Name	Type	# Bytes	Description
HKDCode	int	4	HKD-File Code (=837854832)
N	int	4	Number of recorded samples
HKDTimeRef	int	4	Time reference (1: UTC, 0: Local Time)
HKDSelect ⁽¹⁾	int	4	Selects the recorded data groups of this file
T_1	int	4	Time of sample 1 (# of sec. since 1.1.2001)
Alarm_1 ⁽²⁾	char	1	Alarm flag of sample 1 (0: ok, 1: alarm)
Longitude_1 ⁽³⁾	float	4	GPS longitude of sample 1 (only if bit 1 of HKDSelect is set to '1')
Latitude_1 ⁽³⁾	float	4	GPS latitude of sample 1 (only if bit 1 of HKDSelect is set to '1')
T[0,...,3]_1	float	4x4	Temperatures of sample 1. T[0]=ambient target sensor 1, T[1]=ambient target sensor 2 (if present), T[2]=humidity profiler receiver(1), T[3]=temperaure profiler receiver(2) (only if bit 2 of HKDSelect is set to '1'), unit [K]
Stab[0,1]_1	float	2x4	Temperature stability of receiver 1 and 2 (only if bit 3 of HKDSelect is set to '1'), unit [K]
Flash_1	int	4	Remaining flash memory (only if bit 4 of HKDSelect is set to '1'), unit [kBytes]
Quality_1 ⁽⁴⁾	int	4	Quality flags of sample 1 (only if bit 5 of HKDSelect is set to '1')
Status_1 ⁽⁵⁾	int	4	Status flags of sample 1 (only if bit 5 of HKDSelect is set to '1')
...
T_N	int	4	Time of sample N (# of sec. since 1.1.2001)
Alarm_N ⁽²⁾	char	1	Alarm flag of sample N (0: ok, 1: alarm)
Longitude_N ⁽³⁾	float	4	GPS longitude of sample N (only if bit 1 of HKDSelect is set to '1')
Latitude_N ⁽³⁾	float	4	GPS latitude of sample N (only if bit 1 of HKDSelect is set to '1')
T[0,...,3]_N	float	4x4	Temperatures of sample N. T[0]=ambient target sensor 1, T[1]=ambient target sensor 2 (if present), T[2]=humidity profiler receiver(1), T[3]=temperaure profiler receiver(2) (only if bit 2 of HKDSelect is set to '1'), unit [K]
Stab[0,1]_N	float	2x4	Temperature stability of receiver 1 and 2 (only



			if bit 3 of HKDSelect is set to '1'), unit [K]
Flash_N	int	4	Remaining flash memory (only if bit 4 of HKDSelect is set to '1'), unit [kBytes]
Quality_N⁽⁴⁾	int	4	Quality flags of sample N (only if bit 5 of HKDSelect is set to '1')
Status_N⁽⁵⁾	int	4	Status flags of sample N (only if bit 5 of HKDSelect is set to '1')

⁽¹⁾ **HKDSelect:** Only the first byte of this integer value is used for selection of data groups. The meaning of the various bit settings of this byte is the following:

Bit 1: When this bit is set to '1', the GPS-position (longitude, latitude) is recorded in this file, otherwise not.

Bit 2: When this bit is set to '1', the temperature data is recorded in this file, otherwise not.

Bit 3: When this bit is set to '1', the receiver stability data is recorded in this file, otherwise not.

Bit 4: When this bit is set to '1', the remaining flash memory is recorded in this file, otherwise not.

Bit 5: When this bit is set to '1', quality flags are recorded in this file, otherwise not.

Bit 6: When this bit is set to '1', status flags are recorded in this file, otherwise not.

⁽²⁾ **Alarm:** The alarm flag is activated in the following cases:

- interference or failure of a channel that is used in one of the retrievals
- thermal receiver stability not sufficient for measurement
- noise diode failure of one of the receivers
- ambient target thermal sensor not stable

⁽³⁾ **GPS longitude / latitude format:** (-)DDDMM.mmmm, longitude is negative: West of 0-meridian, latitude is negative: South of equator. 'DDD' is measured in degrees (0-180 for longitude, 0-90 for latitude), 'MM' is measured in minutes ('), 'mmmm' is the decimal fraction of 'MM'. Example: longitude = -12245.50 means 122°45'30" West, latitude = -3321.25 means 33°21'15" South.

⁽⁴⁾ **Quality Flags:** This 4 byte unsigned integer is subdivided into 8 groups of 4 bits:

MSB yyxx yyxx yyxx yyxx yyxx yyxx yyxx yyxx LSB
 LP STA TPB TPC HPC DLY IWV LWP

Each group represents the quality flags of a certain level 2 product (retrieved data). The 'xx' bits are coded in the following way:

- 'xx' = 0: this level 2 product is not evaluated for quality control
- 'xx' = 1: highest quality level
- 'xx' = 2: reduced quality
- 'xx' = 3: low quality. This sample should not be used.

The 'yy' bits are coding the possible reasons for reduced or low quality sampling:

- 'yy' = 0: unknown
- 'yy' = 1: possible external interference on a receiver channel or failure of a receiver channel that is used in the retrieval of this product.
- 'yy' = 2: LWP too high. At high rain rates the scattering on rain drops can mask the water vapour line completely and no humidity profiling or IWV determination is



possible. Also the temperature profiling may be affected when the oxygen line channels are all saturated due to droplets.

- 'yy' = 3: free for future use.

(5) Status Flags:

- Bit 1-7: status flags for channel 1 to 7 of the humidity profiler receiver. When a bit is set '1', the corresponding channel is ok, otherwise the channel has a malfunction.
- Bit 8: not used
- Bit 9-15: status flags for channel 1 to 7 of the temperature profiler receiver. When a bit is set '1', the corresponding channel is ok, otherwise the channel has a malfunction.
- Bit 16: not used
- Bit 17: rain flag. '1' means raining, '0' = no rain
- Bit 18: dew blower speed status. '1' = high speed mode, '0' = low speed mode
- Bit 19: BL-mode flag. '1' = boundary layer scanning active, '0' = BL-mode not active
- Bit 20: '1' = sky tipping calibration running, '0' = not active
- Bit 21: '1' = noise calibration running, '0' = not active
- Bit 22: '1' = gain calibration running (using internal ambient target), '0' = not active
- Bit 23: '1' = noise diode of humidity profiler ok, '0' = noise diode not working
- Bit 24: '1' = noise diode of temperature profiler ok, '0' = noise diode not working
- Bits 25,26: receiver 1 (humidity profiler) thermal stability. '0' = unknown, not enough data samples recorded yet, '1' = stability ok, '2' = not sufficiently stable
- Bits 27,28: receiver 2 (temperature profiler) thermal stability. '0' = unknown, not enough data samples recorded yet, '1' = stability ok, '2' = not sufficiently stable
- Bit 29: power failure flag. '1' = a power failure has occurred recently. When a new MDF has been started automatically after a power failure, the '1' flag is kept for 1000 seconds and switching back to '0' afterwards. '0' = no power failure occurred.
- Bit 30: ambient target stability: Some radiometers are using two ambient target temperature sensors for monitoring the target's physical temperature. When the temperature readings of these two sensors differ for more than 0.3 K, the flag turns to '1'. '0' = sensors ok.
- Bit 31: noise diode status: '0' = noise diode is turned off for the current sample, '1' = noise diode is turned on for the current sample.

A19: ABSCAL.HIS, Absolute Calibration History File

Variable Name	Type	# Bytes	Description
HISCode	int	4	HIS-File Code (=39583209)
N	int	4	Number of calibration entries
EntryLen1	int	4	Length of entry #1 in bytes
Radiometer-ID1	int	4	1=TEMPRO, 2=HUMPRO, 3=HATPRO, 4=RPG-15-90, 5=LHATPRO, 6=RPG-150-90, 7= RPG-36-90, 8=RPG-LWP, 9=RPG-LWP-U90, 10 =RPG-DP150-90, 11=HALO-KV, 12=HALO-183, 13=HALO-119-90
Cal1Type1	int	4	Calibration type receiver 1, entry #1 (0: no calibration, 1: Abs. Cal. With LN, 2:Skydip calibration)
Cal2Type1	int	4	Calibration type receiver 2, entry #1 (0: no calibration, 1: Abs. Cal. With LN, 2:Skydip)



			calibration)
T1_1	int	4	Time of calibration receiver 1 , entry #1 (# of sec. since 1.1.2001)
T2_1	int	4	Time of calibration receiver 2 , entry #1 (# of sec. since 1.1.2001)
ATemp1_1	float	4	Ambient temperature receiver 1, entry #1 [K]
ATemp2_1	float	4	Ambient temperature receiver 2, entry #1 [K]
P1_1	float	4	Barom. pressure receiver 1, entry #1 [mbar]
P2_1	float	4	Barom. pressure receiver 2, entry #1 [mbar]
HLTemp1_1	float	4	Hotload temp. receiver 1, entry #1 [K]
HLTemp2_1	float	4	Hotload temp. receiver 2, entry #1 [K]
CLTemp1_1	float	4	Coldload temp. receiver 1, entry #1 [K]
CLTemp2_1	float	4	Coldload temp. receiver 2, entry #1 [K]
Spare[5]	float	4x5	20 spare bytes, entry #1
NRec1Ch	int	4	Number of receiver 1 channels, entry #1
ChF1[1... NRec1Ch]	float	4x NRec1Ch	Frequencies of receiver 1, entry #1
NRec2Ch	int	4	Number of receiver 2 channels, entry #1
ChF2[1... NRec2Ch]	float	4x NRec2Ch	Frequencies of receiver 2, entry #1
Calibrated1[]	int	4x(NRec1Ch+NRec2Ch)	Calibration flags for all channels, entry #1 (0=not calibrated, 1=calibrated)
Gain1[]	float	4x(NRec1Ch+NRec2Ch)	Receiver gains for all channels, entry #1 [V/K]
NoiseT1[]	float	4x(NRec1Ch+NRec2Ch)	Noise diode temperature for all channels, entry #1 [K]
TSys1[]	float	4x(NRec1Ch+NRec2Ch)	System noise temperature for all channels, entry #1 [K]
Alpha1[]	float	4x(NRec1Ch+NRec2Ch)	Non-linearity factors for all channels, entry #1
...
EntryLenN	int	4	Length of entry #N in bytes
Radiometer-IDN	int	4	1=TEMPRO, 2=HUMPRO, 3=HATPRO, 4=RPG-15-90, 5=LHATPRO, 6=RPG-150-90, 7= RPG-36-90, 8=RPG-LWP, 9=RPG-LWP-U90, 10 =RPG-DP150-90, 11=HALO-KV, 12=HALO-183, 13=HALO-119-90
Cal1TypeN	int	4	Calibration type receiver 1, entry #N (0: no calibration, 1: Abs. Cal. With LN, 2:Skydip calibration)
Cal2TypeN	int	4	Calibration type receiver 2, entry #N (0: no calibration, 1: Abs. Cal. With LN, 2:Skydip calibration)
T1_N	int	4	Time of calibration receiver 1 , entry #N (# of sec. since 1.1.2001)
T2_N	int	4	Time of calibration receiver 2 , entry #N (# of sec. since 1.1.2001)
ATemp1_N	float	4	Ambient temperature receiver 1, entry #N [K]



A _{Temp2} _N	float	4	Ambient temperature receiver 2, entry #N [K]
P1_N	float	4	Barom. pressure receiver 1, entry #N [mbar]
P2_N	float	4	Barom. pressure receiver 2, entry #N [mbar]
HL _{Temp1} _N	float	4	Hotload temp. receiver 1, entry #N [K]
HL _{Temp2} _N	float	4	Hotload temp. receiver 2, entry #N [K]
CL _{Temp1} _N	float	4	Coldload temp. receiver 1, entry #N [K]
CL _{Temp2} _N	float	4	Coldload temp. receiver 2, entry #N [K]
Spare[5]	float	4x5	20 spare bytes, entry #N
NRec1Ch	int	4	Number of receiver 1 channels, entry #N
ChF1[1... NRec1Ch]	float	4x NRec1Ch	Frequencies of receiver 1, entry #N
NRec2Ch	int	4	Number of receiver 2 channels, entry #N
ChF2[1... NRec2Ch]	float	4x NRec2Ch	Frequencies of receiver 2, entry #N
Calibrated1[]	int	4x(NRec1Ch+ NRec2Ch)	Calibration flags for all channels, entry #N (0=not calibrated, 1=calibrated)
GainN[]	float	4x(NRec1Ch+ NRec2Ch)	Receiver gains for all channels, entry #N [V/K]
NoiseTN[]	float	4x(NRec1Ch+ NRec2Ch)	Noise diode temperature for all channels, entry #N [K]
TSysN[]	float	4x(NRec1Ch+ NRec2Ch)	System noise temperature for all channels, entry #N [K]
AlphaN[]	float	4x(NRec1Ch+ NRec2Ch)	Non-linearity factors for all channels, entry #N

A20: LV0-Files (*.LV0), Level Zero (Detector Voltages) Data Files

Variable Name	Type	# Bytes	Description
LV0Code	int	4	HIS-File Code (=111111)
N	int	4	Number of samples
MasterID ⁽¹⁾	int	4	ID number of Master Radiometer
SlaveID ⁽¹⁾	int	4	ID number of Slave Radiometer
TimeRef	int	4	Time Reference (0=Local, 1=UTC)
FreqNo	int	4	Number of Frequencies
Freqs[]	float	4*FreqNo	Frequencies [GHz]
Longitude	float	4	GPS longitude (refer to FN (3), HKD-files)
Latitude	float	4	GPS latitude (refer to FN (3), HKD-files)
Alpha[] ⁽²⁾	float	4*FreqNo	Alpha calibration parameters
DelT[] ⁽³⁾	float	4*FreqNo	DelT calibration Parameters [K]
T_1	int	4	Time of sample 1 (# of sec. since 1.1.2001)
Ud_1[]	float	4*FreqNo	Detector Voltages [V] of sample 1
Elevation_1	float	4	Elevation Angle [°] of sample 1
Azimuth_1	float	4	Azimuth Angle [°] of sample 1
MaTambient_1	float	4	Black Body Temperature [K] of Master radiometer, sample 1
MaDigFlags_1	int	4	Digital Flags of Master radiometer, sample 1, refer to FN (5) of HKD-files



SITambient_1	float	4	Black Body Temperature [K] of Slave radiometer, sample 1 (only if SlaveID ≠ 0)
SIDigFlags_1	int	4	Digital Flags of Slave radiometer, sample 1, refer to FN (5) of HKD-files (only if SlaveID ≠ 0)
G_1[]	float	4*FreqNo	Gain calibration parameters [V/K], sample 1
Tsys_1[]	float	4*FreqNo	System Noise Temperature calibration parameters Tsys [K], sample 1
Tn_1[]	float	4*FreqNo	Noise Diode Temperature calibration parameters Tn [K], sample 1
Tenv_1	float	4	Environmental Temperature [K] of sample 1
P_1	float	4	Barometric Pressure [mbar] of sample 1
RH_1	float	4	Relative Humidity [%] of sample 1
IRT_1	float	4	Infrared Radiometer Temperature [K] of sample 1
...
T_N	int	4	Time of sample N (# of sec. since 1.1.2001)
Ud_N[]	float	4*FreqNo	Detector Voltages [V] of sample N
Elevation_N	float	4	Elevation Angle [°] of sample N
Azimuth_N	float	4	Azimuth Angle [°] of sample N
MaTambient_N	float	4	Black Body Temperature [K] of Master radiometer, sample N
MaDigFlags_N	int	4	Digital Flags of Master radiometer, sample N, refer to FN (5) of HKD-files
SITambient_N	float	4	Black Body Temperature [K] of Slave radiometer, sample N (only if SlaveID ≠ 0)
SIDigFlags_N	int	4	Digital Flags of Slave radiometer, sample N, refer to FN (5) of HKD-files (only if SlaveID ≠ 0)
G_N[]	float	4*FreqNo	Gain calibration parameters [V/K], sample N
Tsys_N[]	float	4*FreqNo	System Noise Temperature calibration parameters Tsys [K], sample N
Tn_N[]	float	4*FreqNo	Noise Diode Temperature calibration parameters Tn [K], sample N
Tenv_N	float	4	Environmental Temperature [K] of sample N
P_N	float	4	Barometric Pressure [mbar] of sample N
RH_N	float	4	Relative Humidity [%] of sample N
IRT_N	float	4	Infrared Radiometer Temperature [K] of sample N

⁽¹⁾ ID number coding: 0=no rad., 1=RPG-TEMPRO, 2=RPG-HUMPRO, 3=RPG-HATPRO, 4=RPG-15-90, 5=RPR-LHUMPRO, 6=RPG-150-90, 7=RPG-36-90, 8=RPG-DP150-90

⁽²⁾ Alpha Parameter: Non-Linearity Parameter for radiometer which are not operated in Full-Dicke Switching mode (Dicke Switching + Noise Switching) like RPG-TEMPRO, RPG-HUMPRO, RPG-HATPRO, RPG-LHUMPRO, RPG-36-90, RPG-DP150-90



- Dicke Switch Leakage for radiometers that are operated in Full-Dicke Switching mode (Dicke Switching + Noise Switching) like RPG-150-90, RPG-15-90 and RPG-HATPRO-U
- ⁽³⁾ DelT Parameter: Difference between radiometric (T_{DSr}) and physical (T_{Dsp}) Dicke Switch temperature: $DelT = T_{DSr} - T_{Dsp}$, only relevant for Full Dicke Switching radiometers

Notes on Calibrations

Relation between detector voltages U_d and scene temperatures T_{sc} :

$U_d = G (T_{sys} + T_{sc})^{Alpha}$, for radiometers without Full Dicke Switching Mode (Type 1)
 $U_d = G (T_{sys} + T_{sc})$, for radiometers with Full Dicke Switching Mode (Type 2)

System Noise Temperature T_{sys} , Noise Diode Temp. T_N and Gain G :

Absolute Calibrations (Hot / Cold): detector voltages on black body target (temperature $T_H = T_{amb}$): U_H , cold target (LN or Skydip, temperature T_C): U_C :

$Y = (U_H / U_C)^{1/Alpha}$, $T_{sys} = (T_H - Y * T_C)/(Y - 1)$, $0.95 < Alpha <= 1$ (sec. 4.1.3.1), Type 1

$Y = (U_H / U_C)$, $T_{sys} = (T_H - Y * T_C)/(Y - 1)$, Type 2

$G = U_H / (T_{sys} + T_H)^{Alpha}$, Type 1

$G = U_H / (T_{sys} + T_H)$, Type 2

On black body target (T_{amb}), noise diode turned off: U_{-N} , noise diode turned on: U_{+N}

$T_N = (U_{+N} / G)^{1/Alpha} - T_{sys} - T_{amb}$, Type 1

$T_N = (U_{+N} - U_{-N}) / G$, Type 2

Type 2 only: Dicke Switch (DS) ON, radiometer pointing to amb. temp. target:

$DelT = U_{DS} / G - T_{sys} - T_{Dsp}$,

Dicke Switch (DS) leakage (Type 2 only): DS ON, radiometer pointing to cold target:

$Alpha = (T_{Dsp} + DelT - (U_{DS} / G - T_{sys})) / (T_{Dsp} + DelT - T_C)$

If a liquid nitrogen cooled target is used, the following correction has to be applied:

$T_C [K] = 77.36 - 8.2507e-3 * (1013.25 - P) + 1.9$, P in mbar, 1.9 K is correction for surface reflection on LN (n = 1.2)

Continuous full calibration on scene (Type 2 only): Noise Diode turned off: U_{-N} , noise diode turned on: U_{+N} , radiometers looking on scene temperature T_{sc} , Dicke switch turned ON (blocking scene), physical Dicke switch temperature T_{Dsp} :

$G = (U_{+N} - U_{-N}) / T_N$, $T_{sys} = U_{-N} / G - (T_{Dsp} + DelT - Alpha * (T_{Dsp} - T_{sc}))$, Alpha= DS leakage (determined in absolute calibration)

Continuous noise switching on scene (Type 1 only): noise diode turned off: U_{-N} , noise diode turned on: U_{+N} (10 Hz), radiometers pointing to scene (temperature T_{sc}):

$D = (U_{+N} / U_{-N})^{1/Alpha} - 1$, $T_{sc} = (T_N - D * T_{sys}) / D$, $G = U_{-N} / (T_{sys} + T_{sc})^{Alpha}$

Calibration on ambient temp. black body target (T_{amb}): $T_{sys} = (U_d / G)^{1/Alpha} - T_{amb}$

Type 1, no noise switching:



gain calibration on ambient temp. target (T_{amb}): $G = U_d / (T_{sys} + T_{amb})^{Alpha}$

noise calibration on ambient temp. target (T_{amb}):

$$D = (U_{+N} / U_{-N})^{1/Alpha} - 1, T_{sys} = (T_N - D * T_{amb}) / D, G = U_{-N} / (T_{sys} + T_{amb})^{Alpha}$$

Appendix B (ASCII File Formats)

Fig.B1 shows an example of an ASCII data file structure (LWP). All ASCII files start with a header giving information about the number of samples in the file, Minimum and Maximum values of the measured or retrieved quantities for scaling purposes, the time reference (UTC or local time) and the type of retrieval if any (0 = linear regression, 1 = quadratic regression, 2 = neural network). Comments are preceded by '#'.

Each sample line starts with the date and time (Ye = Year, Mo = Month, Da = Day, Ho = Hour, Mi = Minute, Se = Second) this sample was measured followed by the rain flag (0 = no rain, 1 = raining). All data columns are separated by ',' from each other. Each line ends with CR/LF.

```
# LWP File
7177 # Number of Samples
-55.6 # Minimum LWP in File
605.3 # Maximum LWP in File
1 # Time Reference (1=UTC, 0=Local)
1 # Retrieval Algorithm (0=LR, 1=QR, 2=NN)
# Ye, Mo, Da, Ho, Mi, Se, Rain Flag, LWP [g/m^2]
05, 04, 09, 04, 00, 01, 0, -23.6
05, 04, 09, 04, 00, 02, 0, -22.8
05, 04, 09, 04, 00, 04, 0, -22.8
05, 04, 09, 04, 00, 05, 0, -27.5
05, 04, 09, 04, 00, 06, 0, -25.8
05, 04, 09, 04, 00, 08, 0, -18.9
05, 04, 09, 04, 00, 09, 0, -21.3
05, 04, 09, 04, 00, 11, 0, -26.2
05, 04, 09, 04, 00, 12, 0, -21.2
05, 04, 09, 04, 00, 13, 0, -26.8
05, 04, 09, 04, 00, 15, 0, -20.6
05, 04, 09, 04, 00, 16, 0, -17.8
05, 04, 09, 04, 00, 18, 0, -31.9
05, 04, 09, 04, 00, 19, 0, -25.1
05, 04, 09, 04, 00, 21, 0, -22.9
05, 04, 09, 04, 00, 22, 0, -26.3
05, 04, 09, 04, 00, 23, 0, -23.3
05, 04, 09, 04, 00, 25, 0, -29.7
05, 04, 09, 04, 00, 26, 0, -26.3
05, 04, 09, 04, 00, 28, 0, -19.5
05, 04, 09, 04, 00, 29, 0, -32.0
05, 04, 09, 04, 00, 31, 0, -21.0
05, 04, 09, 04, 00, 32, 0, -27.1
```

Fig.B1: LWP ASCII data file structure.

Fig.B2 is an example of a temperature profile ASCII file. The header contains additional information about the number of altitude levels and the altitudes in m. The altitude levels are designated with H1, H2, ... The data lines are a sequence of temperature values corresponding to these levels.



```

050429.TPC.ASC - Editor
Datei Bearbeiten Format Ansicht ?
# TPC File
841 # Number of Samples
235.6 # Minimum Temperature in File
301.8 # Maximum Temperature in File
0 # Time Reference (1=UTC, 0=Local)
0 # Retrieval Algorithm (0=LR, 1=QR, 2=NN)
36 # Number of Altitude Levels
0, 50, 100, 150, 200, 250, 325, 400, 475, 550, 625, 700, 800, 900, 1000, 1150, 1300, 1450, 1600, 180
# Ye, Mo, Da, Ho, Mi, Se, Rain Flag, T(H1) [K], T(H2) [K], ..., T(Hn) [K]
05, 04, 29, 00, 01, 24, 0, 299.4, 298.9, 298.4, 298.2, 297.9, 297.7, 297.4, 297.1, 29
05, 04, 29, 00, 02, 48, 0, 299.2, 298.6, 298.1, 297.9, 297.5, 297.3, 297.0, 296.8, 29
05, 04, 29, 00, 07, 41, 0, 299.4, 299.0, 298.5, 298.2, 297.9, 297.6, 297.3, 297.0, 29
05, 04, 29, 00, 09, 05, 0, 299.3, 299.0, 298.5, 298.2, 297.9, 297.6, 297.3, 297.0, 29
05, 04, 29, 00, 10, 29, 0, 299.2, 299.0, 298.6, 298.3, 298.0, 297.7, 297.4, 297.0, 29
05, 04, 29, 00, 11, 54, 0, 299.4, 299.3, 298.9, 298.5, 298.2, 297.9, 297.6, 297.2, 29
05, 04, 29, 00, 13, 18, 0, 299.1, 298.9, 298.5, 298.2, 297.9, 297.7, 297.4, 297.1, 29
05, 04, 29, 00, 15, 23, 0, 299.1, 298.9, 298.5, 298.2, 297.9, 297.6, 297.3, 297.0, 29
05, 04, 29, 00, 16, 47, 0, 299.2, 298.9, 298.5, 298.2, 297.9, 297.6, 297.2, 296.9, 29
05, 04, 29, 00, 18, 11, 0, 299.2, 299.0, 298.6, 298.2, 297.9, 297.6, 297.3, 296.9, 29
05, 04, 29, 00, 19, 35, 0, 299.1, 299.0, 298.6, 298.3, 298.0, 297.7, 297.4, 297.0, 29
05, 04, 29, 00, 20, 59, 0, 299.0, 298.9, 298.5, 298.2, 297.9, 297.6, 297.3, 297.0, 29
05, 04, 29, 00, 22, 23, 0, 299.2, 299.0, 298.5, 298.2, 297.9, 297.6, 297.3, 296.9, 29
05, 04, 29, 00, 24, 27, 0, 299.3, 299.0, 298.6, 298.3, 298.0, 297.7, 297.4, 297.0, 29
05, 04, 29, 00, 25, 51, 0, 299.3, 299.0, 298.5, 298.3, 297.9, 297.7, 297.3, 297.0, 29
05, 04, 29, 00, 30, 45, 0, 299.3, 299.1, 298.7, 298.4, 298.1, 297.8, 297.5, 297.1, 29
05, 04, 29, 00, 32, 50, 0, 299.3, 299.3, 298.9, 298.6, 298.3, 298.0, 297.7, 297.3, 29
05, 04, 29, 00, 34, 14, 0, 299.3, 299.2, 298.8, 298.4, 298.1, 297.9, 297.5, 297.2, 29
05, 04, 29, 00, 35, 39, 0, 299.4, 299.3, 298.9, 298.6, 298.3, 298.0, 297.7, 297.4, 29
05, 04, 29, 00, 37, 03, 0, 299.6, 299.6, 299.2, 298.9, 298.6, 298.3, 298.0, 297.6, 29
05, 04, 29, 00, 38, 27, 0, 299.7, 299.7, 299.3, 299.0, 298.7, 298.4, 298.1, 297.7, 29

```

Fig.B2: TPC profile ASCII data file structure.

The brightness temperature data file in Fig.B3 specifies the frequency list in the header instead of altitudes. The data lines list the brightness temperatures related to these frequencies and end with the observation elevation angle for the sample.

```

050429.OLC.ASC - Editor
Datei Bearbeiten Format Ansicht ?
# OLC File
50427 # Number of Samples
130.6 # Minimum Brightness Temp. in File
302.5 # Maximum Brightness Temp. in File
0 # Time Reference (1=UTC, 0=Local)
7 # Number of Frequencies
51.26, 52.28, 53.86, 54.94, 56.66, 57.30, 58.00 # Frequencies
# Ye, Mo, Da, Ho, Mi, Se, Rain Flag, BT(F1) [K], BT(F2) [K], ..., BT(Fn), Ang [DEG]
05, 04, 29, 00, 01, 0, 262.62, 272.65, 290.41, 295.21, 297.45, 297.55, 297.35, 90.00
05, 04, 29, 00, 02, 0, 261.91, 270.95, 289.81, 295.22, 297.21, 297.40, 297.43, 90.00
05, 04, 29, 00, 03, 0, 262.06, 271.77, 290.60, 296.33, 297.87, 298.02, 297.72, 90.00
05, 04, 29, 00, 04, 0, 262.15, 269.88, 289.40, 295.37, 296.84, 297.47, 297.58, 90.00
05, 04, 29, 00, 06, 0, 260.65, 269.02, 289.88, 295.34, 297.99, 298.70, 298.46, 90.00
05, 04, 29, 00, 07, 0, 260.11, 269.14, 289.59, 295.04, 297.64, 297.89, 297.15, 90.00
05, 04, 29, 00, 09, 0, 262.02, 268.99, 290.40, 295.66, 298.06, 297.42, 297.76, 90.00
05, 04, 29, 00, 10, 0, 260.34, 272.79, 290.16, 296.21, 298.05, 297.81, 297.25, 90.00
05, 04, 29, 00, 12, 0, 260.64, 265.77, 291.06, 295.45, 298.16, 298.41, 297.92, 90.00
05, 04, 29, 00, 13, 0, 260.05, 269.64, 290.08, 295.38, 298.11, 298.38, 297.38, 90.00
05, 04, 29, 00, 14, 0, 259.72, 268.99, 287.61, 295.92, 297.06, 297.48, 297.55, 90.00
05, 04, 29, 00, 15, 0, 258.74, 270.65, 289.71, 295.72, 298.38, 298.00, 297.96, 90.00
05, 04, 29, 00, 18, 0, 258.92, 269.13, 290.69, 295.18, 297.04, 297.88, 297.65, 90.00
05, 04, 29, 00, 19, 0, 258.87, 267.83, 291.08, 296.20, 297.91, 297.76, 297.87, 90.00
05, 04, 29, 00, 20, 0, 258.25, 266.92, 288.93, 295.39, 296.42, 297.37, 297.08, 90.00

```

Fig.B3: OLC brightness temperature ASCII data file structure.

Fig.B4 is an example for a meteorological surface sensor data file (MET). Here the header lists minimum and maximum values for each sensor type.

In Fig.B5 the file contains both the absolute and relative humidity chart. The latter is preceded by the minimum and maximum relative humidity values in the appended chart.



```
050429.MET.ASC - Editor
Datei Bearbeiten Format Ansicht ?
# MET File
65687 # Number of Samples
999.8 # Minimum Pressure Value in File [mbar]
1003.8 # Maximum Pressure Value in File [mbar]
297.2 # Minimum Temperature Value in File [K]
303.1 # Maximum Temperature Value in File [K]
79.6 # Minimum Rel. Humidity Value in File [%]
93.2 # Maximum Rel. Humidity in File [%]
0 # Time Reference (1=UTC, 0=Local)
# Ye, Mo, Da, Ho, Mi, Se, Rain Flag, P [mbar], T [K], H [%]
05, 04, 29, 00, 00, 00, 0, 1003.2, 300.3, 92.1
05, 04, 29, 00, 00, 01, 0, 1003.2, 300.3, 92.1
05, 04, 29, 00, 00, 02, 0, 1003.2, 300.3, 92.1
05, 04, 29, 00, 00, 03, 0, 1003.2, 300.3, 92.1
05, 04, 29, 00, 00, 05, 0, 1003.2, 300.3, 92.2
05, 04, 29, 00, 00, 06, 0, 1003.2, 300.3, 92.2
05, 04, 29, 00, 00, 07, 0, 1003.1, 300.3, 92.2
05, 04, 29, 00, 00, 09, 0, 1003.2, 300.3, 92.2
05, 04, 29, 00, 00, 11, 0, 1003.2, 300.3, 92.2
05, 04, 29, 00, 00, 12, 0, 1003.2, 300.3, 92.2
05, 04, 29, 00, 00, 13, 0, 1003.2, 300.3, 92.2
05, 04, 29, 00, 00, 14, 0, 1003.1, 300.3, 92.2
05, 04, 29, 00, 00, 16, 0, 1003.2, 300.3, 92.3
```

Fig.B4: MET meteorological sensor ASCII data file structure.

```
05043021.HPC.ASC - Editor
Datei Bearbeiten Format Ansicht ?
# HPC File
21 # Number of Samples
0.3 g/m^3 # Minimum absolute Humidity in File
13.3 g/m^3 # Maximum absolute Humidity in File
0 # Time Reference (1=UTC, 0=Local)
1 # Retrieval Algorithm (0=LR, 1=QR, 2=NN)
36 # Number of Altitude Levels
0, 50, 100, 150, 200, 250, 325, 400, 475, 550, 625, 700, 800, 900, 1000, 1150, 1300, 1450, 1600, 1800, 2000
# Ye, Mo, Da, Ho, Mi, Se, Rain Flag, H(HL) [g/m^3], H(H2) [g/m^3], ..., H(Hn) [g/m^3]
05, 04, 30, 21, 29, 06, 0, 9.6, 10.2, 9.7, 9.7, 9.6, 9.2, 8.7, 8.1, 7.7,
05, 04, 30, 21, 30, 30, 0, 9.5, 10.1, 9.6, 9.5, 9.1, 8.6, 8.0, 7.7,
05, 04, 30, 21, 31, 54, 0, 9.7, 10.3, 9.8, 9.8, 9.7, 9.3, 8.9, 8.2, 7.9,
05, 04, 30, 21, 33, 19, 0, 9.7, 10.4, 9.9, 9.8, 9.7, 9.4, 8.9, 8.3, 8.0,
05, 04, 30, 21, 34, 43, 0, 9.8, 10.5, 10.0, 10.0, 9.8, 9.5, 9.0, 8.4, 8.1,
05, 04, 30, 21, 36, 07, 0, 9.7, 10.4, 9.9, 9.8, 9.7, 9.3, 8.9, 8.2, 7.9,
05, 04, 30, 21, 37, 31, 0, 9.7, 10.4, 10.0, 9.9, 9.8, 9.4, 9.0, 8.4, 8.1,
05, 04, 30, 21, 42, 27, 0, 9.7, 10.4, 9.9, 9.8, 9.7, 9.4, 8.9, 8.3, 8.0,
05, 04, 30, 21, 43, 51, 0, 9.7, 10.3, 9.8, 9.8, 9.7, 9.3, 8.9, 8.2, 7.9,
05, 04, 30, 21, 45, 15, 0, 9.7, 10.3, 9.8, 9.7, 9.6, 9.3, 8.8, 8.1, 7.8,
05, 04, 30, 21, 46, 39, 0, 9.6, 10.3, 9.8, 9.7, 9.6, 9.3, 8.8, 8.1, 7.8,
05, 04, 30, 21, 48, 03, 0, 9.5, 10.1, 9.6, 9.5, 9.4, 9.0, 8.5, 7.9, 7.5,
05, 04, 30, 21, 49, 27, 0, 9.7, 10.2, 9.7, 9.6, 9.5, 9.2, 8.7, 8.0, 7.7,
05, 04, 30, 21, 50, 52, 0, 9.7, 10.3, 9.8, 9.7, 9.6, 9.3, 8.8, 8.1, 7.8,
05, 04, 30, 21, 52, 16, 0, 9.7, 10.3, 9.8, 9.8, 9.7, 9.3, 8.9, 8.2, 7.9,
05, 04, 30, 21, 53, 40, 0, 9.7, 10.3, 9.8, 9.8, 9.7, 9.3, 8.8, 8.2, 7.8,
05, 04, 30, 21, 55, 04, 0, 9.7, 10.3, 9.8, 9.8, 9.7, 9.3, 8.8, 8.2, 7.8,
05, 04, 30, 21, 56, 28, 0, 9.7, 10.4, 9.8, 9.8, 9.7, 9.3, 8.8, 8.2, 7.8,
05, 04, 30, 21, 57, 52, 0, 9.7, 10.4, 9.9, 9.9, 9.8, 9.4, 8.9, 8.3, 7.9,
05, 04, 30, 21, 59, 17, 0, 9.7, 10.4, 9.9, 9.9, 9.8, 9.4, 8.9, 8.3, 7.9,
05, 04, 30, 21, 59, 58, 0, 9.8, 10.6, 10.0, 10.0, 9.9, 9.5, 8.4, 7.9,
39.5% # Minimum relative Humidity in File
100.0% # Maximum relative Humidity in File
# Ye, Mo, Da, Ho, Mi, Se, Rain Flag, H(HL) [%], H(H2) [%], ..., H(Hn) [%]
05, 04, 30, 21, 29, 06, 0, 45.7, 49.7, 48.5, 49.3, 49.7, 48.7, 46.9, 43.9, 41.8,
05, 04, 30, 21, 30, 30, 0, 45.4, 49.0, 47.9, 48.6, 49.1, 48.1, 46.4, 43.4, 41.4,
05, 04, 30, 21, 31, 54, 0, 46.4, 50.2, 49.0, 49.9, 50.4, 49.4, 47.8, 45.0, 42.9,
05, 04, 30, 21, 33, 19, 0, 46.5, 50.9, 49.7, 50.5, 51.0, 50.0, 48.3, 45.4, 43.3,
05, 04, 30, 21, 34, 43, 0, 46.8, 51.5, 50.3, 51.2, 51.7, 50.7, 49.1, 46.3, 44.3,
05, 04, 30, 21, 36, 07, 0, 46.6, 50.8, 49.6, 50.4, 50.8, 49.7, 48.1, 45.2, 43.1,
05, 04, 30, 21, 37, 31, 0, 46.7, 51.3, 50.2, 51.0, 51.5, 50.4, 48.8, 45.9, 43.8,
05, 04, 30, 21, 42, 27, 0, 46.9, 50.9, 49.8, 50.7, 51.2, 50.2, 48.6, 45.7, 43.6,
05, 04, 30, 21, 43, 51, 0, 46.1, 50.4, 49.2, 50.1, 50.6, 49.5, 48.0, 45.1, 43.0,
05, 04, 30, 21, 45, 15, 0, 46.1, 50.0, 48.8, 49.7, 50.2, 49.1, 47.5, 44.6, 42.6,
05, 04, 30, 21, 46, 39, 0, 46.2, 50.4, 49.2, 50.0, 50.5, 49.4, 47.8, 44.9, 42.8,
05, 04, 30, 21, 48, 03, 0, 46.2, 49.8, 48.6, 49.3, 49.7, 48.6, 46.7, 43.7, 41.5,
05, 04, 30, 21, 49, 27, 0, 46.3, 49.9, 48.7, 49.6, 50.0, 48.9, 47.1, 44.1, 42.0,
05, 04, 30, 21, 50, 52, 0, 46.5, 50.4, 49.1, 50.0, 50.4, 49.3, 47.7, 44.7, 42.6,
05, 04, 30, 21, 52, 16, 0, 46.5, 50.5, 49.3, 50.3, 50.8, 49.8, 48.3, 45.4, 43.4,
05, 04, 30, 21, 53, 40, 0, 46.1, 50.2, 49.0, 50.0, 50.4, 49.3, 47.7, 44.8, 42.6,
05, 04, 30, 21, 55, 04, 0, 47.0, 51.2, 49.9, 50.9, 51.3, 50.1, 48.4, 45.4, 43.2,
05, 04, 30, 21, 56, 28, 0, 46.8, 51.1, 49.8, 50.7, 51.1, 50.0, 48.2, 45.3, 43.1,
05, 04, 30, 21, 57, 52, 0, 46.9, 51.7, 50.4, 51.4, 51.8, 50.7, 49.0, 46.0, 43.8,
05, 04, 30, 21, 59, 17, 0, 46.6, 51.0, 49.7, 50.7, 51.2, 50.1, 48.6, 45.8, 43.7,
05, 04, 30, 21, 59, 58, 0, 47.0, 52.2, 50.9, 52.0, 52.4, 51.4, 49.8, 46.9, 44.6,
```

Fig.B5: HPC humidity profile ASCII data file structure with appended relative humidity chart.



```

050624_28.STA.ASC - Editor
Datei Bearbeiten Format Ansicht ?
# Stability Indices File
3476 # Number of Samples
-463.9 # Minimum Index in File
107.0 # Maximum Index in File
1 # LI Flag (1=available, 0=not available)
1 # KOI Flag (1=available, 0=not available)
1 # TTI Flag (1=available, 0=not available)
1 # KI Flag (1=available, 0=not available)
0 # SI Flag (1=available, 0=not available)
0 # CAPE Flag (1=available, 0=not available)
0 # Time Reference (1=UTC, 0=Local)
# Ye, Mo, Da, Ho, Mi, Se, Rain Flag, LI [K], KOI [K], TTI [K], KI [K]
05, 06, 24, 00, 01, 19, 0, 0.1, -4.0, 44.7, 26.7
05, 06, 24, 00, 02, 34, 0, -0.1, -4.0, 44.9, 26.9
05, 06, 24, 00, 03, 49, 0, 0.1, -4.2, 44.7, 26.5
05, 06, 24, 00, 06, 11, 0, -0.0, -4.1, 44.9, 26.7
05, 06, 24, 00, 10, 53, 0, 0.2, -4.3, 44.4, 26.1
05, 06, 24, 00, 12, 08, 0, 0.2, -4.2, 44.5, 26.3
05, 06, 24, 00, 13, 23, 0, 0.3, -4.2, 44.3, 25.9
05, 06, 24, 00, 14, 38, 0, 0.2, -4.2, 44.6, 26.3
05, 06, 24, 00, 15, 53, 0, 0.2, -4.1, 44.8, 26.6
05, 06, 24, 00, 17, 08, 0, 0.4, -4.2, 44.4, 26.0
05, 06, 24, 00, 18, 23, 0, 0.2, -4.2, 44.7, 26.0
05, 06, 24, 00, 23, 05, 0, 0.3, -4.0, 44.7, 25.8
05, 06, 24, 00, 24, 21, 0, 0.3, -4.1, 44.6, 25.8
05, 06, 24, 00, 26, 43, 0, 0.1, -4.2, 44.7, 25.9
05, 06, 24, 00, 27, 58, 0, 0.2, -4.1, 44.8, 25.9
05, 06, 24, 00, 29, 13, 0, 0.3, -4.3, 44.4, 25.3
05, 06, 24, 00, 30, 28, 0, 0.0, -4.2, 45.0, 26.0
05, 06, 24, 00, 31, 43, 0, 0.1, -4.2, 45.0, 25.8
05, 06, 24, 00, 36, 26, 0, 0.0, -4.3, 45.0, 25.8
05, 06, 24, 00, 37, 41, 0, 0.1, -4.4, 44.8, 25.3
05, 06, 24, 00, 38, 56, 0, 0.3, -4.5, 44.4, 24.8
05, 06, 24, 00, 40, 11, 0, 0.2, -4.4, 44.7, 25.1
05, 06, 24, 00, 41, 26, 0, 0.1, -4.5, 44.8, 25.3
05, 06, 24, 00, 42, 41, 0, 0.2, -4.4, 44.7, 25.3
05, 06, 24, 00, 43, 56, 0, 0.1, -4.5, 44.9, 25.3
05, 06, 24, 00, 49, 44, 0, 0.2, -4.4, 44.7, 25.8
05, 06, 24, 00, 50, 59, 0, 0.0, -4.4, 44.9, 26.0
05, 06, 24, 00, 52, 14, 0, -0.2, -4.3, 45.3, 26.3

```

Fig.B6: Stability indices ASCII data file structure.

B1 Housekeeping ASCII file format

Fig.B7 shows the ASCII version of a HKD file (housekeeping data). The explanations for the abbreviations in the legend line are the following:

- **Ye, Mo, Da, Ho, Mi, Se:** Year, Month, Day, Hour, Minute and Second of the sample time
- **AF:** Alarm flag, refer to Appendix A17
- **GPS Long:** GPS Longitude
- **GPS Lat.:** GPS latitude
- **TAmb1:** temperature of ambient target sensor 1
- **TAmb2:** temperature of ambient target sensor 2
- **TRec1:** temperature of receiver 1 (humidity profiler)
- **TRec2:** temperature of receiver 2 (temperature profiler)
- **SRec1:** stability of receiver 1
- **SRec2:** stability of receiver 2
- **Flash D:** remaining flash disk capacity
- **QF LWP,...,QF LPR:** quality flags of LWP, ..., LPR (liquid profile)
- **HP CH:** humidity profiler channel status flags, refer to A17



- **TP CH:** temperature profiler channel status flags, refer to A17
- **RF:** rain flag, refer to A17
- **DB:** dew blower speed status, refer to A17
- **BLM:** boundary layer mode status, refer to A17
- **SCa:** skydip calibration status, refer to A17
- **GCa:** gain calibration status, refer to A17
- **NCa:** noise calibration status, refer to A17
- **ND1:** noise diode receiver 1 status, refer to A17
- **ND2:** noise diode receiver 2 status, refer to A17
- **R1St:** receiver 1 stability status, refer to A17
- **R2St:** receiver 2 stability status, refer to A17
- **PF:** power failure status, refer to A17
- **TarSt:** ambient target stability status, refer to A17

```

07081416.HKD.ASC - Editor
Datei Bearbeiten Format Ansicht 2
# HKD File
2996 # Number of Samples
0 # Time Reference (1=UTC, 0=Local)
1 # 0=GPS position not recorded, 1=GPS position recorded
1 # 0=receiver / ambient temperatures not recorded, 1=receiver / ambient temperatures recorded
1 # 0=receiver stability not recorded, 1=receiver stability recorded
1 # 0=Flash Disk capacity not recorded, 1=Flash Disk capacity recorded
1 # 0=quality flags not recorded, 1=quality flags recorded
1 # 0=instrument status flags not recorded, 1=instrument status flags recorded
#Ye,Mo,Da,Ho,Mi,Se,AF, GPS Long. , GPS Lat. ,TAmb1,TAmb2,TRec1,TRec2,SRec1,SRec2,Flash D,QF LWP,QF IWV,QF
07,08,14,16,00,08,0 , 701.5922, 5038.7744,313.8, 0.0,311.3,313.6,0.003,0.000,0238784, 0000 , 0000 , C
07,08,14,16,00,10,0 , 701.5922, 5038.7744,313.8, 0.0,311.3,313.6,0.003,0.000,0238784, 0000 , 0000 , C
07,08,14,16,00,11,0 , 701.5922, 5038.7744,313.8, 0.0,311.3,313.6,0.003,0.000,0238784, 0000 , 0000 , C
07,08,14,16,00,12,0 , 701.5922, 5038.7744,313.8, 0.0,311.3,313.6,0.002,0.000,0238784, 0000 , 0000 , C
07,08,14,16,00,13,0 , 701.5922, 5038.7744,313.8, 0.0,311.3,313.6,0.002,0.000,0238784, 0000 , 0000 , C
07,08,14,16,00,16,0 , 701.5922, 5038.7744,313.8, 0.0,311.3,313.6,0.002,0.000,0238784, 0000 , 0000 , C
07,08,14,16,00,17,0 , 701.5922, 5038.7744,313.8, 0.0,311.3,313.6,0.002,0.000,0238784, 0000 , 0000 , C
07,08,14,16,00,18,0 , 701.5922, 5038.7744,313.8, 0.0,311.3,313.6,0.002,0.000,0238784, 0000 , 0000 , C
07,08,14,16,00,19,0 , 701.5922, 5038.7744,313.8, 0.0,311.3,313.6,0.002,0.000,0238784, 0000 , 0000 , C
07,08,14,16,00,19,0 , 701.5922, 5038.7744,313.8, 0.0,311.3,313.6,0.002,0.000,0238784, 0000 , 0000 , C
07,08,14,16,00,22,0 , 701.5922, 5038.7744,313.8, 0.0,311.3,313.6,0.002,0.000,0238784, 0000 , 0000 , C
07,08,14,16,00,23,0 , 701.5922, 5038.7744,313.8, 0.0,311.3,313.6,0.002,0.000,0238784, 0000 , 0000 , C
07,08,14,16,00,24,0 , 701.5922, 5038.7744,313.8, 0.0,311.3,313.6,0.002,0.001,0238784, 0000 , 0000 , C
07,08,14,16,00,24,0 , 701.5922, 5038.7744,313.8, 0.0,311.3,313.6,0.002,0.001,0238784, 0000 , 0000 , C
07,08,14,16,00,26,0 , 701.5922, 5038.7744,313.8, 0.0,311.3,313.6,0.002,0.001,0238784, 0000 , 0000 , C
07,08,14,16,00,28,0 , 701.5922, 5038.7744,313.8, 0.0,311.3,313.6,0.002,0.001,0238784, 0000 , 0000 , C
07,08,14,16,00,29,0 , 701.5922, 5038.7744,313.8, 0.0,311.3,313.6,0.002,0.001,0238784, 0000 , 0000 , C
07,08,14,16,00,29,0 , 701.5922, 5038.7744,313.8, 0.0,311.3,313.6,0.002,0.001,0238784, 0000 , 0000 , C
07,08,14,16,00,31,0 , 701.5922, 5038.7744,313.8, 0.0,311.3,313.6,0.002,0.001,0238784, 0000 , 0000 , C
07,08,14,16,00,32,0 , 701.5922, 5038.7744,313.8, 0.0,311.3,313.6,0.002,0.001,0238784, 0000 , 0000 , C
07,08,14,16,00,34,0 , 701.5922, 5038.7744,313.8, 0.0,311.3,313.6,0.002,0.001,0238784, 0000 , 0000 , C
07,08,14,16,00,35,0 , 701.5922, 5038.7744,313.8, 0.0,311.3,313.6,0.002,0.001,0238784, 0000 , 0000 , C
07,08,14,16,00,35,0 , 701.5922, 5038.7744,313.8, 0.0,311.3,313.6,0.002,0.001,0238784, 0000 , 0000 , C
07,08,14,16,00,37,0 , 701.5922, 5038.7744,313.8, 0.0,311.3,313.6,0.002,0.001,0238784, 0000 , 0000 , C
07,08,14,16,00,38,0 , 701.5922, 5038.7744,313.8, 0.0,311.3,313.6,0.002,0.001,0238784, 0000 , 0000 , C
07,08,14,16,00,40,0 , 701.5922, 5038.7744,313.8, 0.0,311.3,313.6,0.002,0.001,0238784, 0000 , 0000 , C
07,08,14,16,00,41,0 , 701.5922, 5038.7744,313.8, 0.0,311.3,313.6,0.002,0.001,0238784, 0000 , 0000 , C
07,08,14,16,00,41,0 , 701.5922, 5038.7744,313.8, 0.0,311.3,313.6,0.002,0.001,0238784, 0000 , 0000 , C

```

Fig.B7: HKD ASCII sample file.



Appendix C (Examples)

C1. Introduction

The RPG-HATPRO humidity and temperature profiling passive microwave radiometer measures a variety of atmospheric quantities with high temporal and spatial resolution. Due to its two 7 channel filterbank receivers it offers a high speed parallel detection of all 14 channels. In contrast to other systems that utilize a sequential channel scanning e.g. with a synthesizer (the classical spectrum analyzer concept) the RPG-HATPRO is capable of performing fast LWP (Liquid Water Path) sampling with 1 second time resolution and outstanding noise performance of $< 2 \text{ g/m}^2 \text{ RMS}$ while simultaneously measuring full troposphere (up to 10 km altitude) profiles of temperature and humidity.

In addition the instrument supports two different scanning modes to achieve a maximum accuracy and vertical resolution for temperature profiling in the full troposphere ($< 10000 \text{ m}$, vertical resolution $150 - 250 \text{ m}$) and boundary layer ($< 1000 \text{ m}$, vertical resolution 50 m). These two modes are referred to as zenith mode (observation only in zenith direction for full troposphere temperature and humidity profiling, LWP, IWV) and boundary layer mode (observation in 6 different elevation angles for boundary layer temperature profiling). In boundary layer mode the system scans the sky in elevation to increase the amount of acquired information by sampling all channels in different directions (down to 5° elevation angle). It has been shown that this method increases the vertical resolution and accuracy of temperature profiles in the atmospheric boundary layer while the zenith mode is best for profiling the whole troposphere with lower vertical resolution. A high vertical resolution in the boundary layer is essential in order to resolve temperature inversions which mainly occur in that layer.

C2. Temperature Profiling

C2.1 Zenith Observation Mode

In zenith observation mode the radiometer only measures in the vertical direction while scanning the water vapour and oxygen lines in Fig.1 continuously. Atmospheric quantities like LWP, IWV and absolute / relative humidity profiles are retrieved from the water vapour line shape and a window channel at 31.4 GHz. The oxygen line complex is only used for temperature profiling of the troposphere.

The RPG-HATPRO radiometer comprises 7 channels on the water vapour line / window and 7 channels on the oxygen line. The frequencies and channel bandwidths are listed in table 1:

f_c [GHz]	22.24	23.04	23.84	25.44	26.24	27.84	31.40	51.26	52.28	53.86	54.94	56.66	57.30	58.00
b[MHz]	230	230	230	230	230	230	230	230	230	230	230	600	1000	2000

Table 1: RPG-HATPRO channel centre frequencies and corresponding bandwidths.

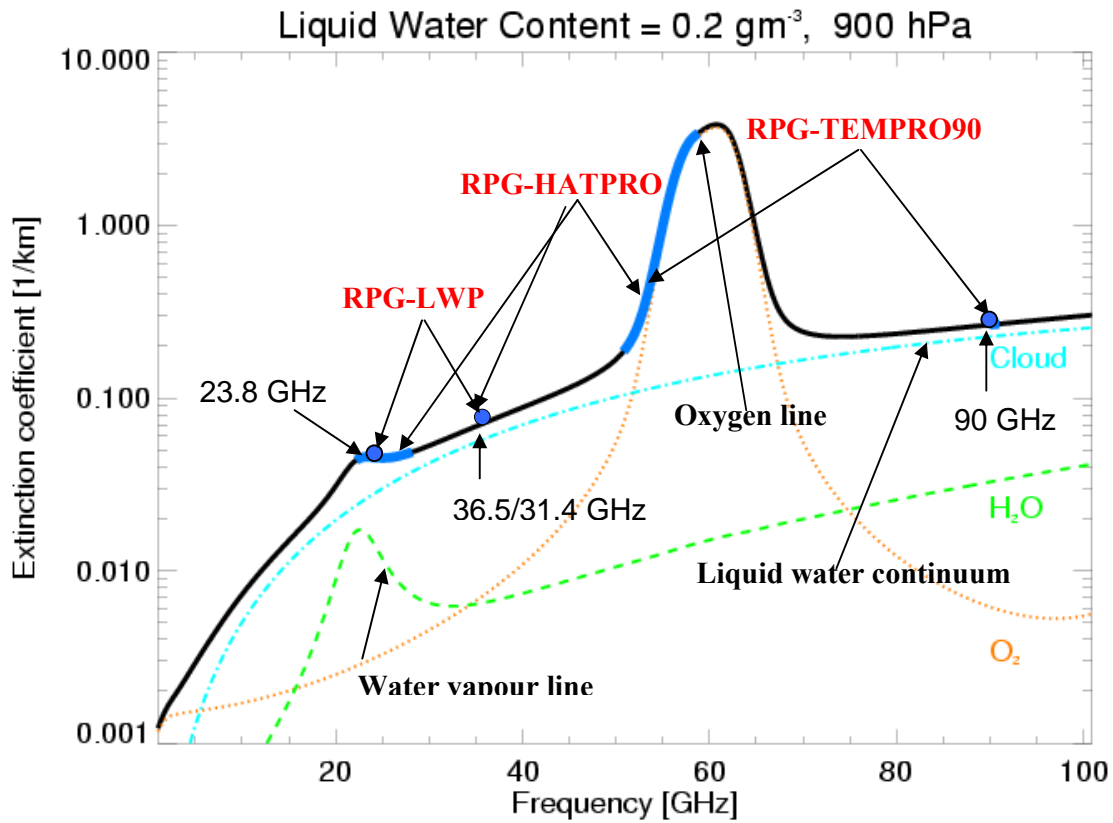

Fig.1: Frequency sets observed in zenith observation mode by various RPG instruments.

C2.2 Boundary Layer Scanning Mode

In boundary layer mode the radiometer scans the atmosphere in elevation to acquire more information about the lower atmospheric layer ($<1000 \text{ m}$) as shown in Fig.2.

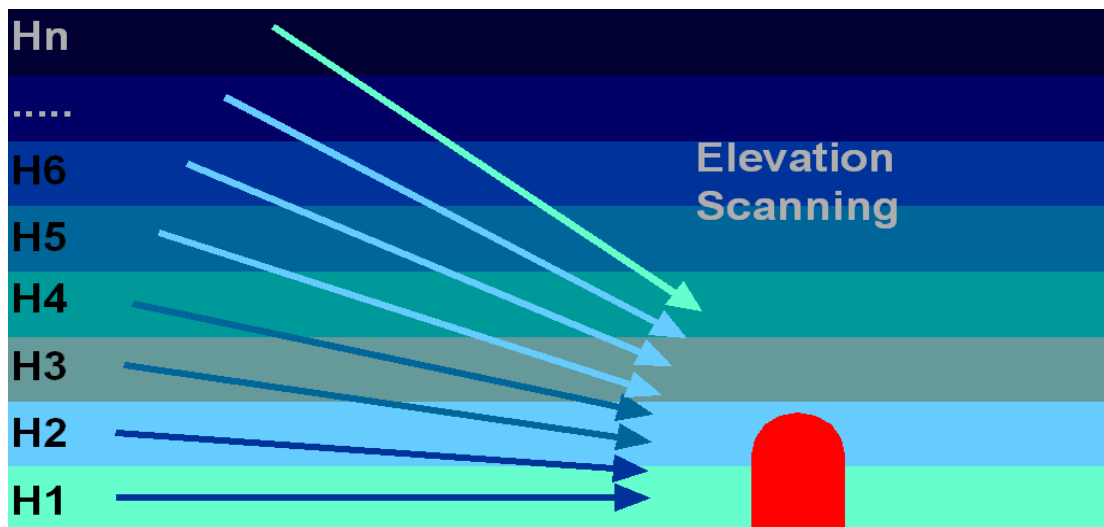

Fig.2: Boundary layer scanning mode with different elevation angles.



For the retrieval of boundary layer temperature profiles only the upper four channels in table 1 are used which show the highest absorption below 1000 m. The variation of brightness temperature in a scan is typically in the order of 1 to 4 K. Thus a sensitive receiver and long integration times are required for the method to achieve the required accuracy. The RPG-HATPRO uses integration times of 20-60 seconds per angle (user selectable) with a total scan time of 2-6 minutes. During this time the zenith observation mode is disabled. A good compromise is a 3 minute scan with a repetition period of 10 to 20 minutes so that the zenith mode is active most of the observation time.

C2.3 Comparison Between the Two Modes

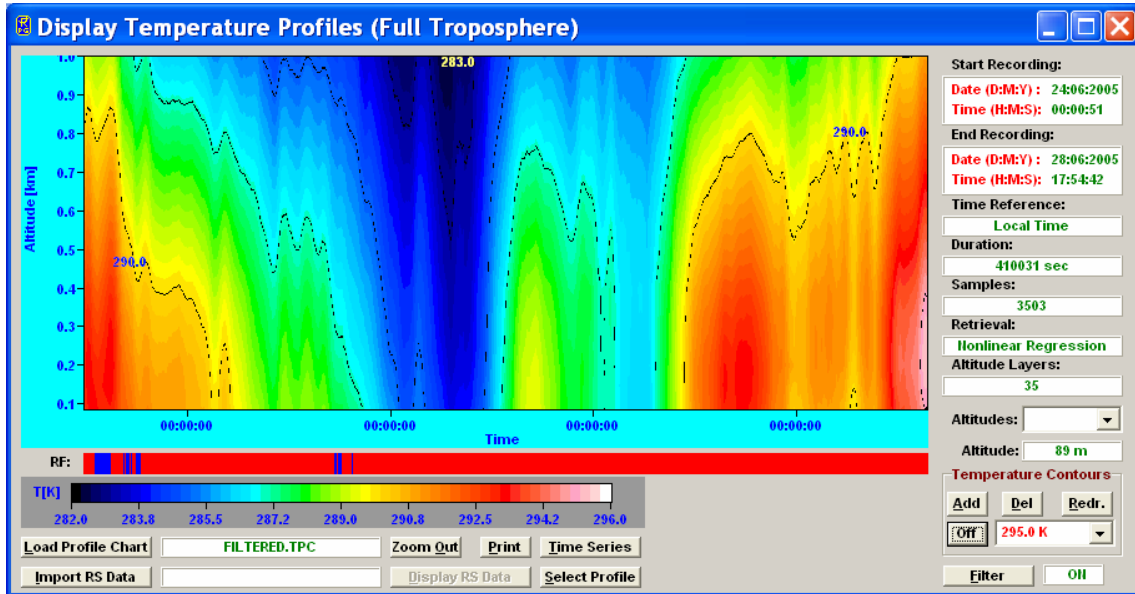

Fig.3a: Zenith observation mode. In the lower 500 m layer the vertical structure is hardly resolved.

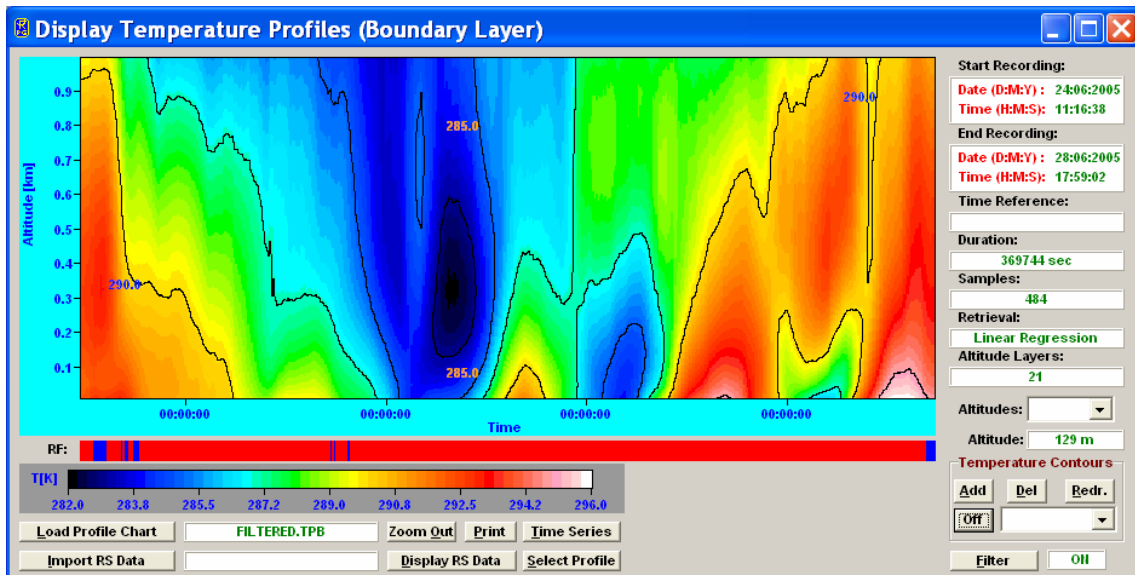

Fig.3b: Boundary layer scanning mode. The vertical structure even in the lowest layer <100 m is clearly resolved.



Fig.3a/b show temperature profile maps of the lowest 1000 m layer measured in zenith mode (Fig.3a) and boundary layer scanning mode (Fig.3b) for a period of 4 days. Only in the left part of the time chart (the first 1.7 days of the recording period) the boundary layer scanning mode observations do not significantly differ from the zenith mode observations. During that period no inversions occurred (see scan A in Fig.4) but after that the boundary layer cooled down (scans B and C in Fig.4) and the first elevated inversions occur (scan C). During the next days inversions are formed between midnight and the morning hours (scans E, H) and dissolved until noon time (scans F, I) by strong solar radiation.

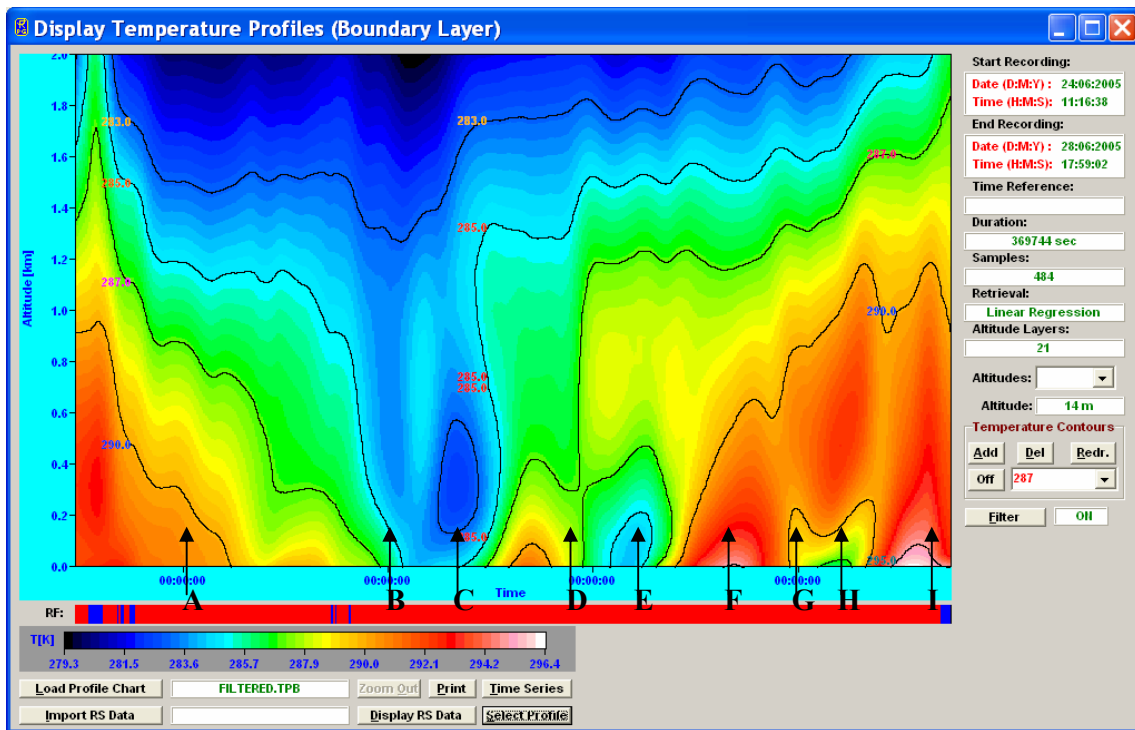
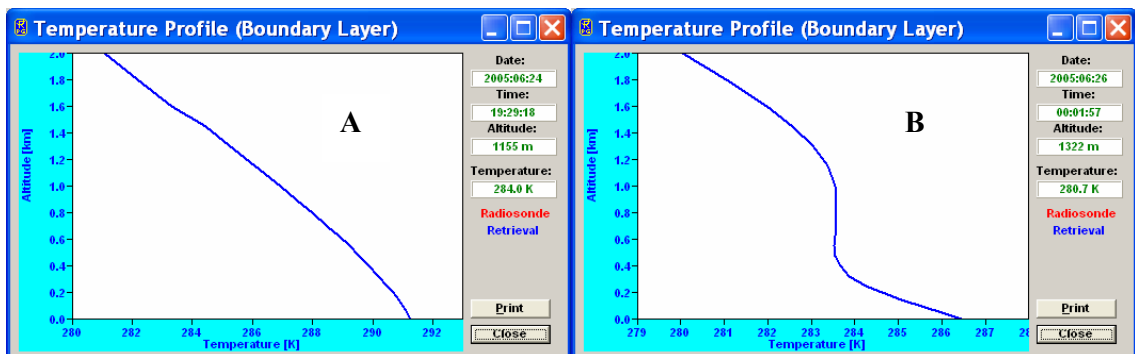
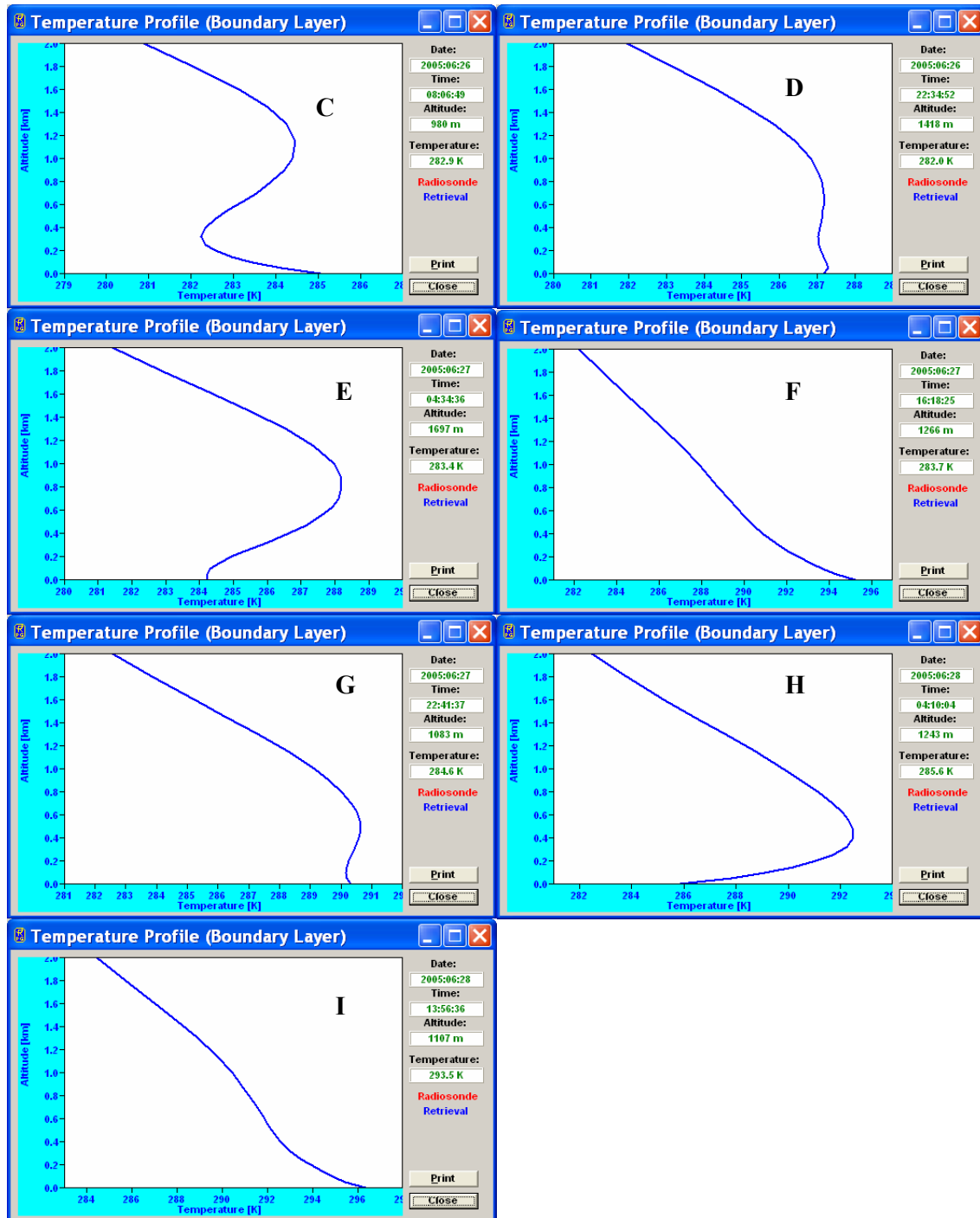

Fig.4: Boundary layer scan temperature profile map of the lowest 2000 m layer. Examples of different scans are given below. The time of the diagram is measured in UTC. 00:00:00 corresponds to midnight.





C2.3.1 Comparison with Radiosonde Data

Fig.5 is an example for a zenith mode observation of the full troposphere up to 10 km during the morning hours (6:00). The radiosonde (in red) was launched about 20 km away from the radiometer site. The RPG-HATPRO profile (in blue) matches well above 1 km altitude but deviates significantly in the lowest 500 m layer. Fig.6 shows the comparison between the radiosonde profile and the radiometer data when operated in boundary layer mode in the lowest 2000 m layer. The ground inversion is resolved much better than in zenith mode.

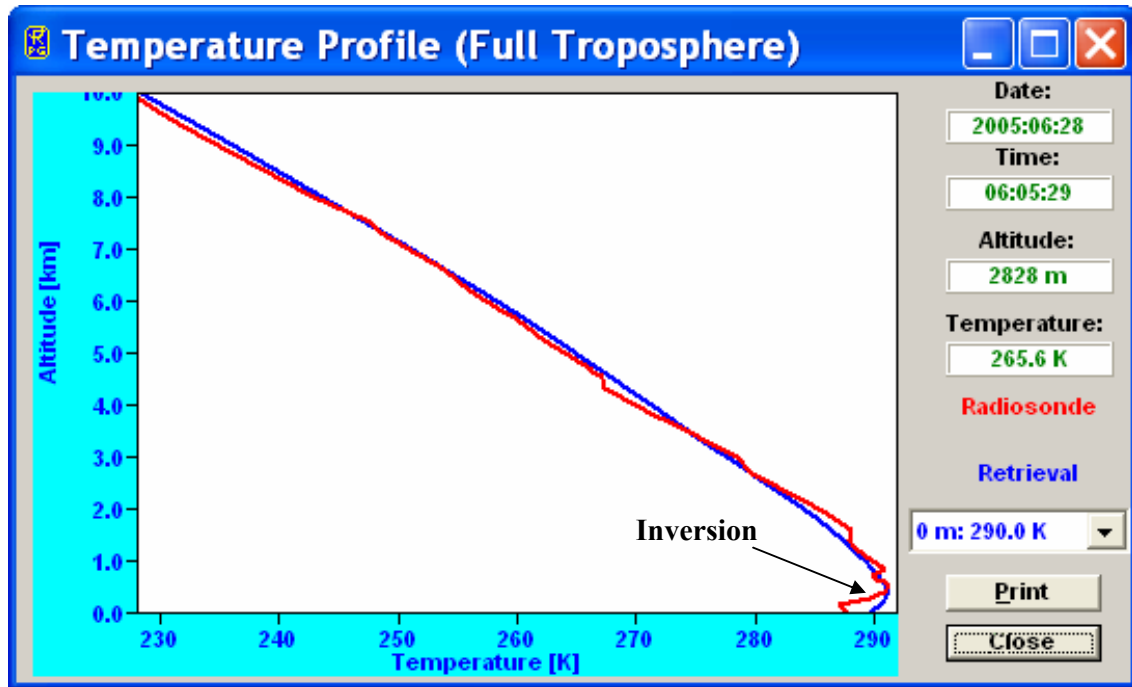

Fig.5: Full troposphere (zenith) scan. Inversion below 1 km is not well resolved (about 1 K)

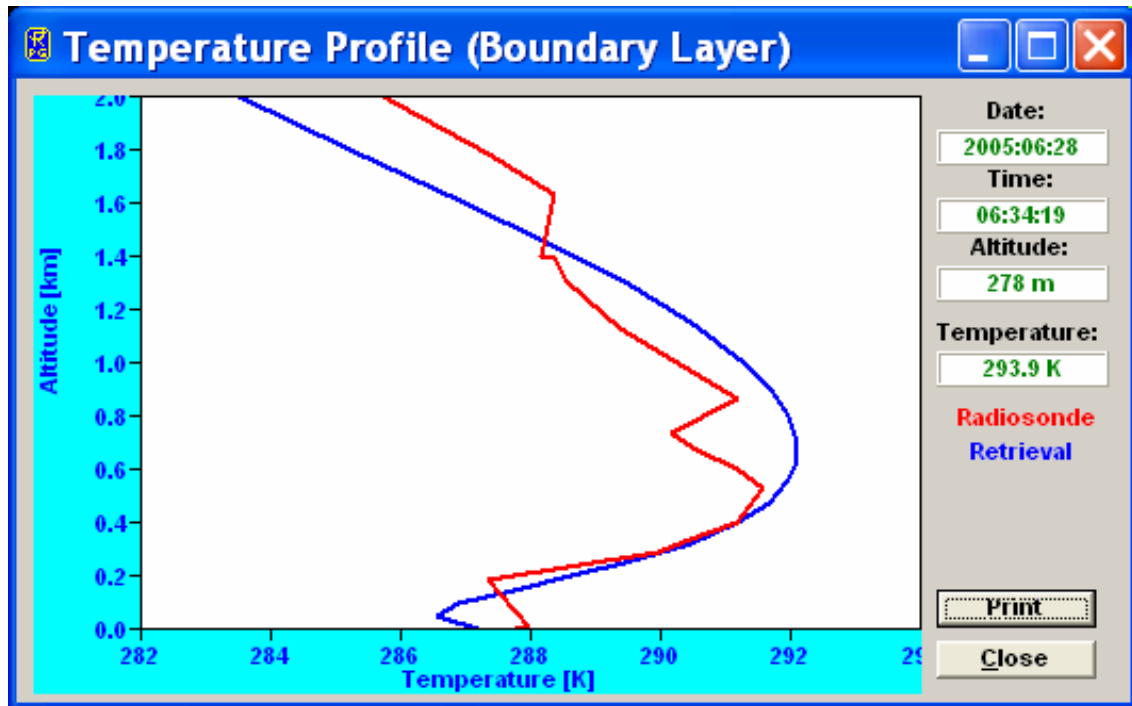

Fig.6: Radiosonde (red) and boundary layer scan (blue) profiles at the same time as above. A strong ground inversion of 4K is resolved.

Fig.7 is a boundary layer scan 6 hours later compared to the radiosonde profile. The inversion has disappeared.

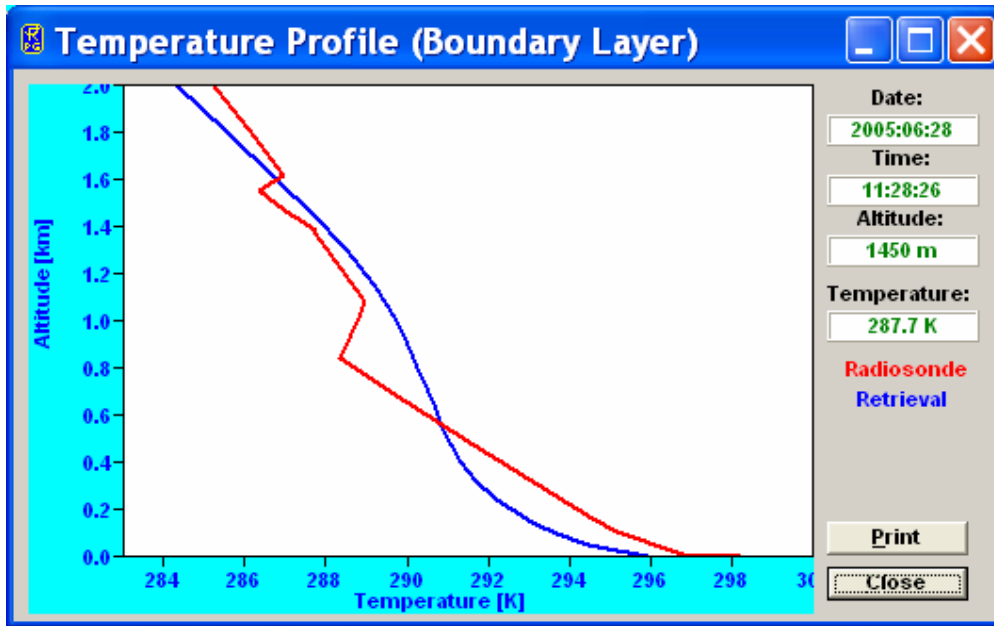
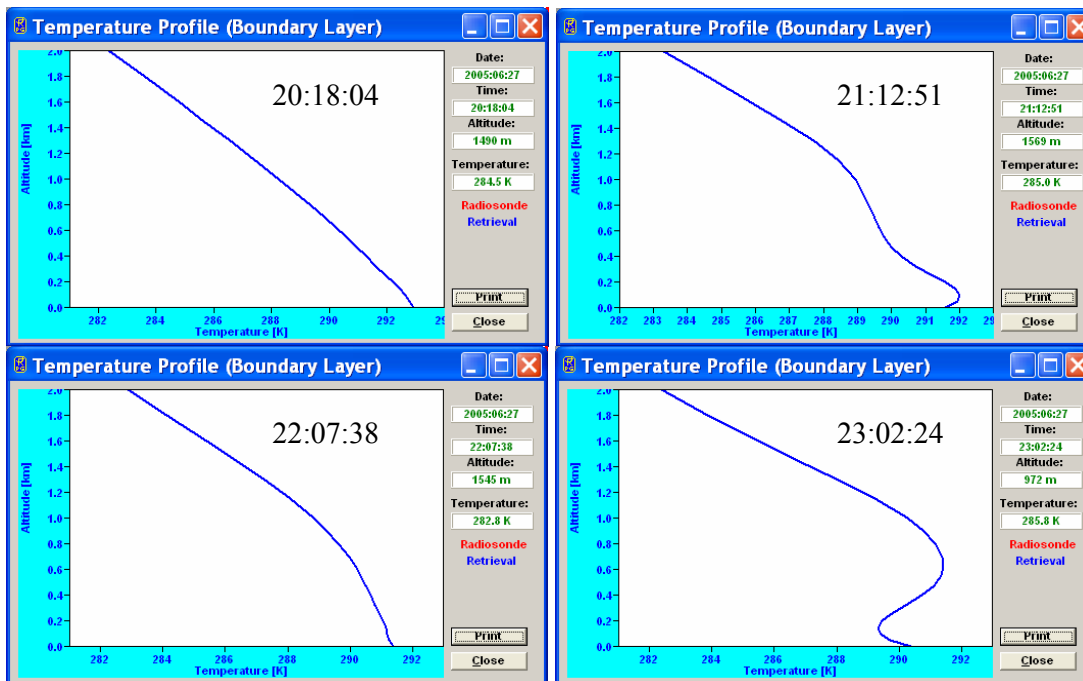
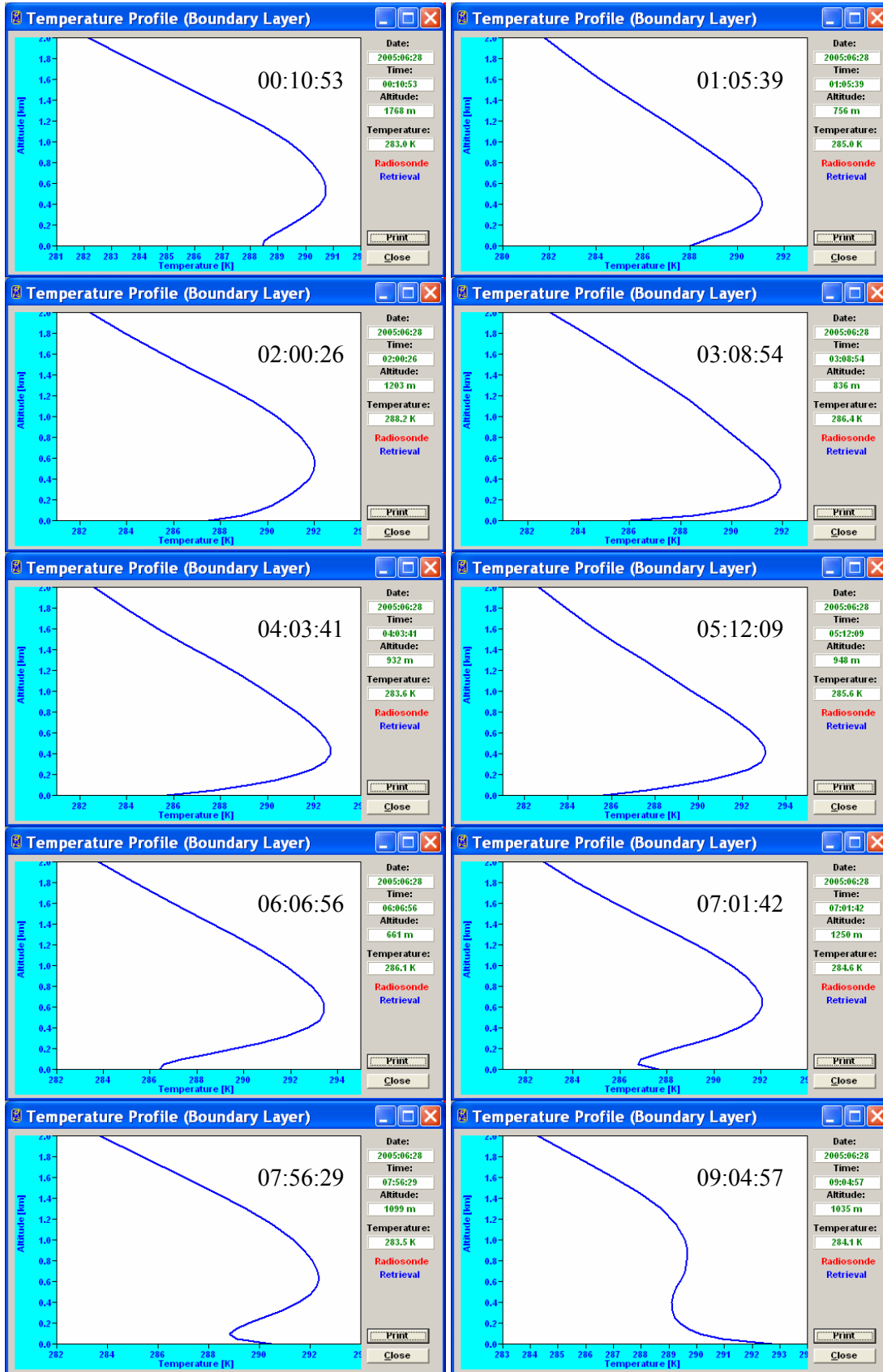

Fig.7: Boundary layer scan around 12:00 UTC.

C2.4 Development and decay of an inversion

In the time series below the development of an inversion and its decay is monitored (in boundary layer mode). The data was recorded in the night 27./28.6.2005:





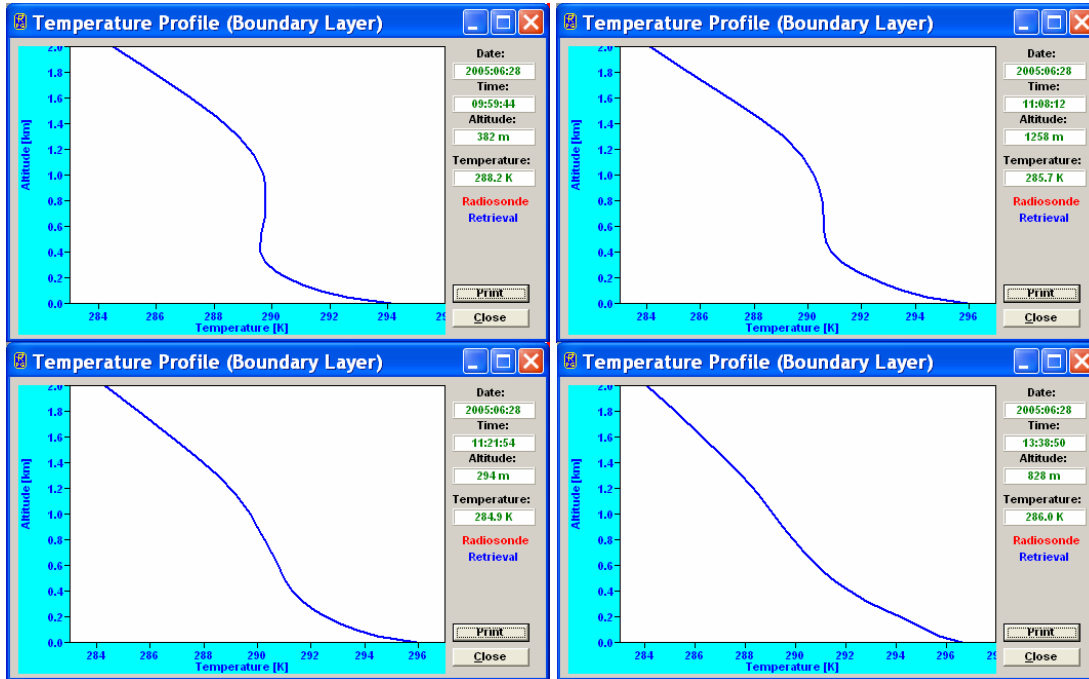

C2.5 Comparison with Meteorological Tower Observations

1) LAUNCH campaign in Lindenberg / Germany (September / October 2005) (Courtesy of Prof. Dr. S. Crewell, University of Munich)

The RPG-HATPRO was located about 40 m from a 99 m met. tower of the DWD (Germany Weather Service).

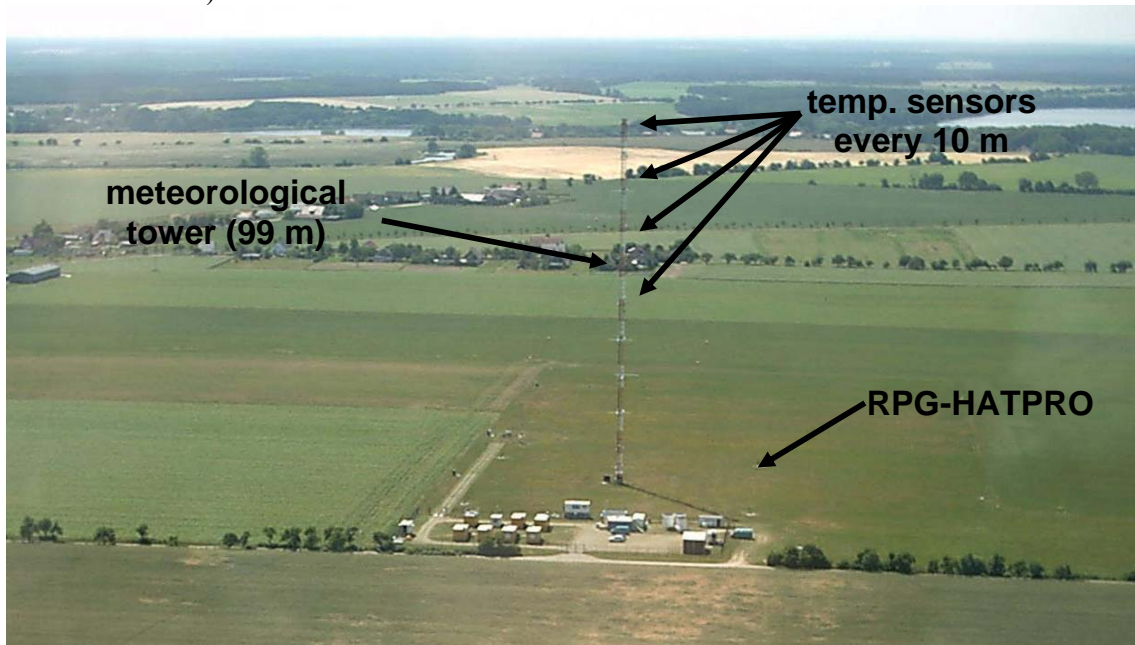

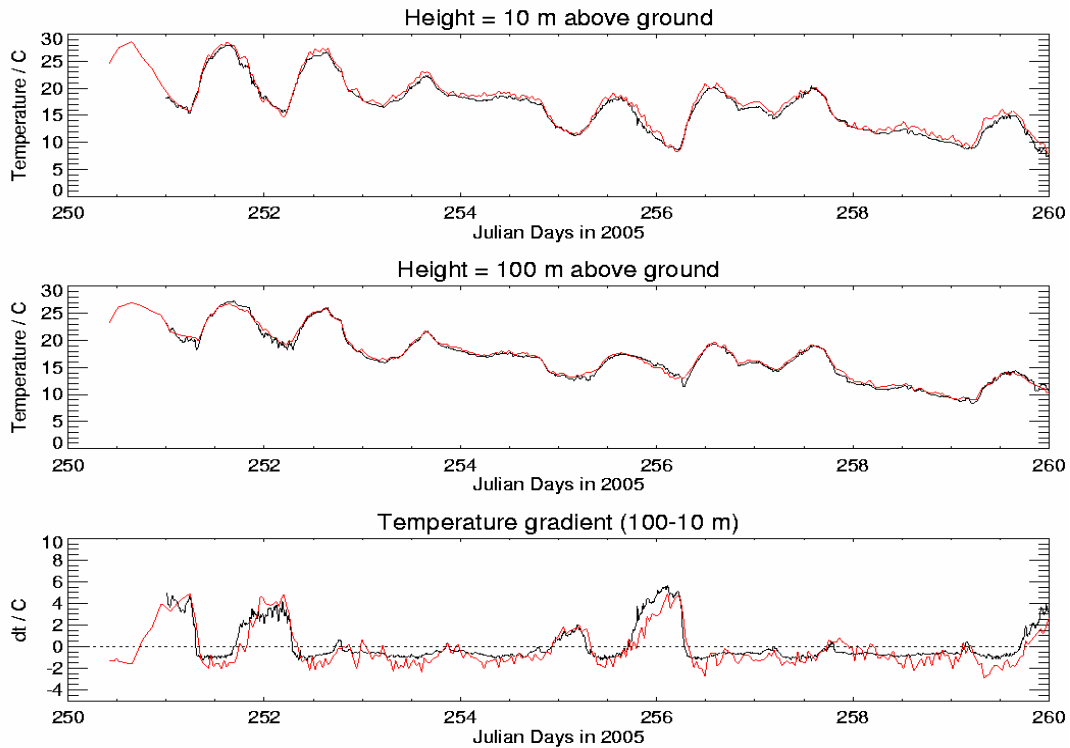

Fig.8a: Comparison of time series of tower temp. sensor (black) and HATPRO measurement (red) at 10 m and 100 m. Below is shown the gradient (difference) indicating that all low level inversions were captured by the instrument.

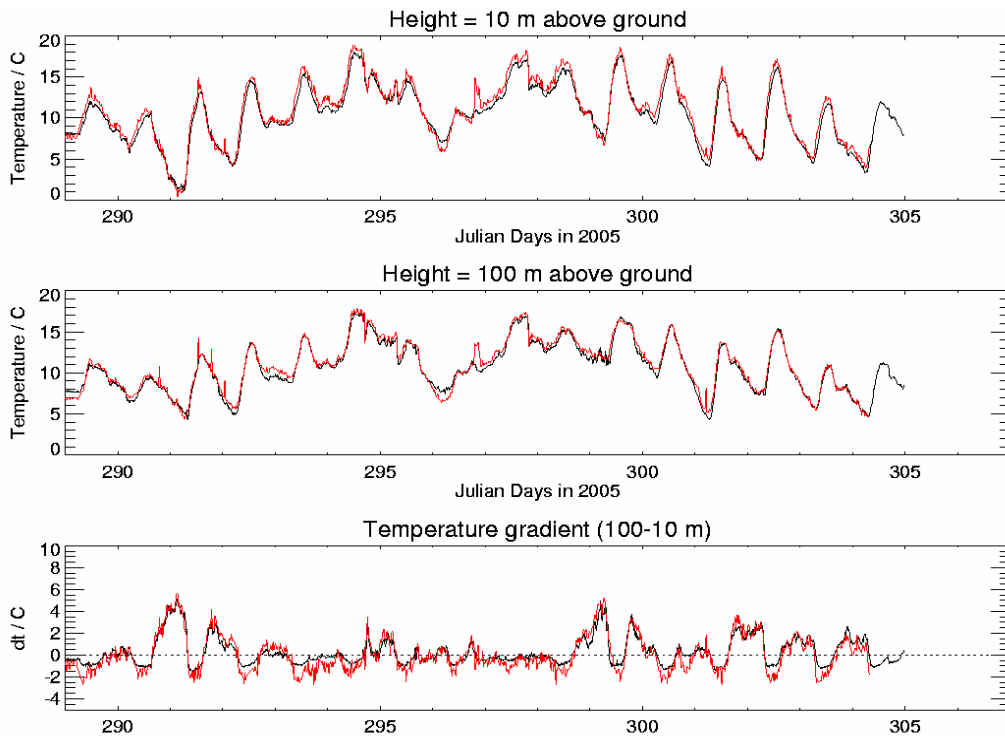

Fig.8b: The same measurement for another period of the campaign.

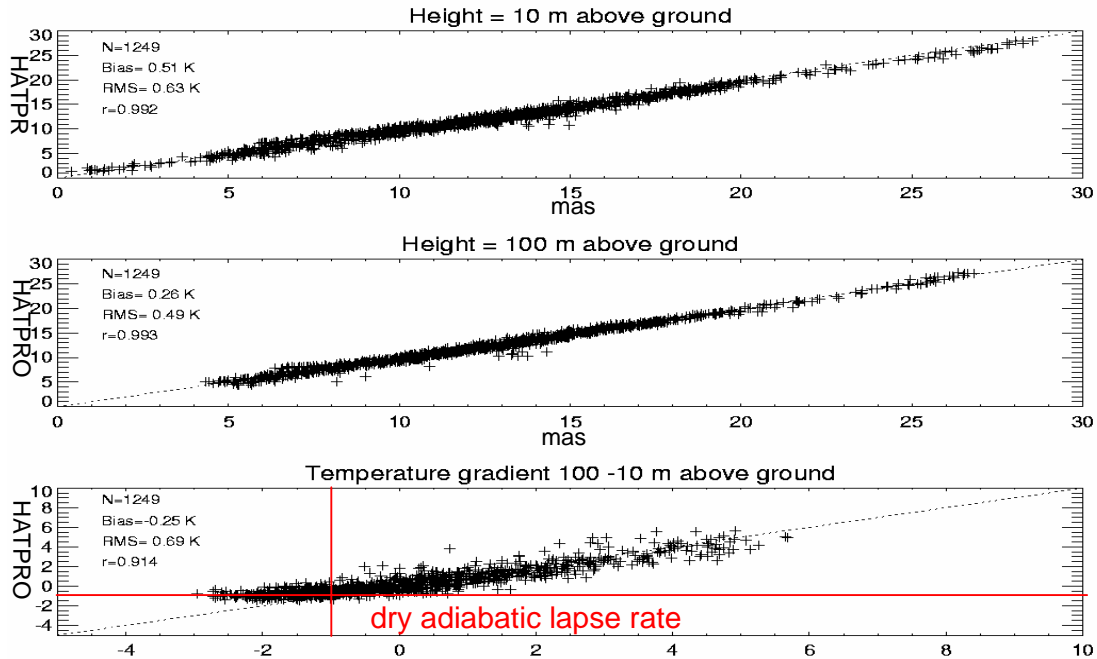

Fig.8c: Scatter plots of the comparison.

We also compared the HATPRO temperature profiles for both measurement modes with radiosonde data measured by a Vaisala RS92 sondes launched about 4 km from the radiometer site (4 times a day). Fig.9/10 show the statistical analysis of the data measured in BL mode and Z mode.

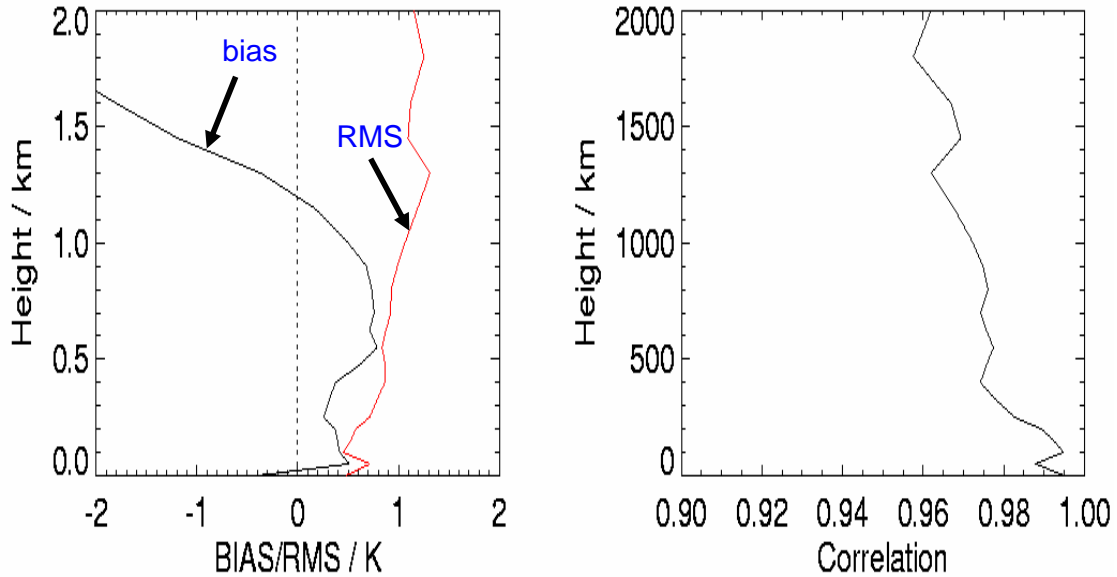

Fig.9: RMS and bias of the BLM temperature observations. Due to the 4 km distance between radio sounding and radiometer the details of the boundary layer are not necessarily the same. The BLM data is most accurate for altitudes < 1200 m.

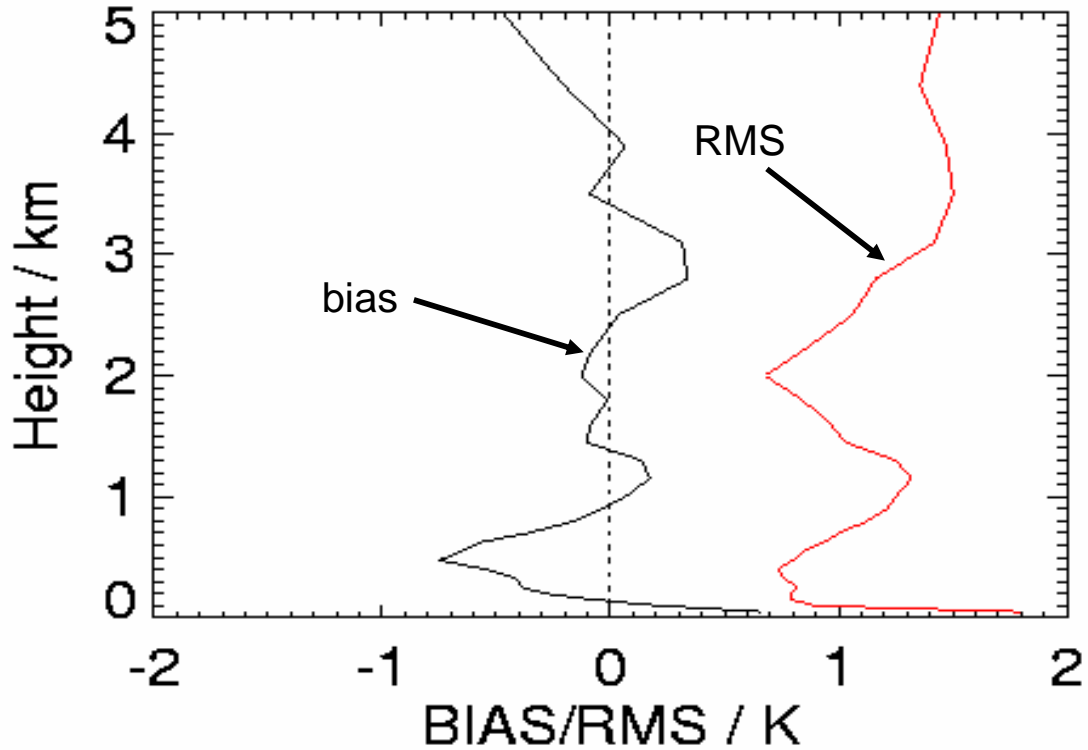

Fig.10: RMS and bias of the ZM temperature observations..

**2) KNMI Met. Tower Observations at Cabauw / Netherlands
(Courtesy of H.Baltink, KNMI Netherlands)**

The Dutch Weather Service operates a 200 m meteorological tower in Cabauw / Netherlands. Fig.13 shows a one month temperature comparison of the 200 m sensor with HATPRO BLM measurements.

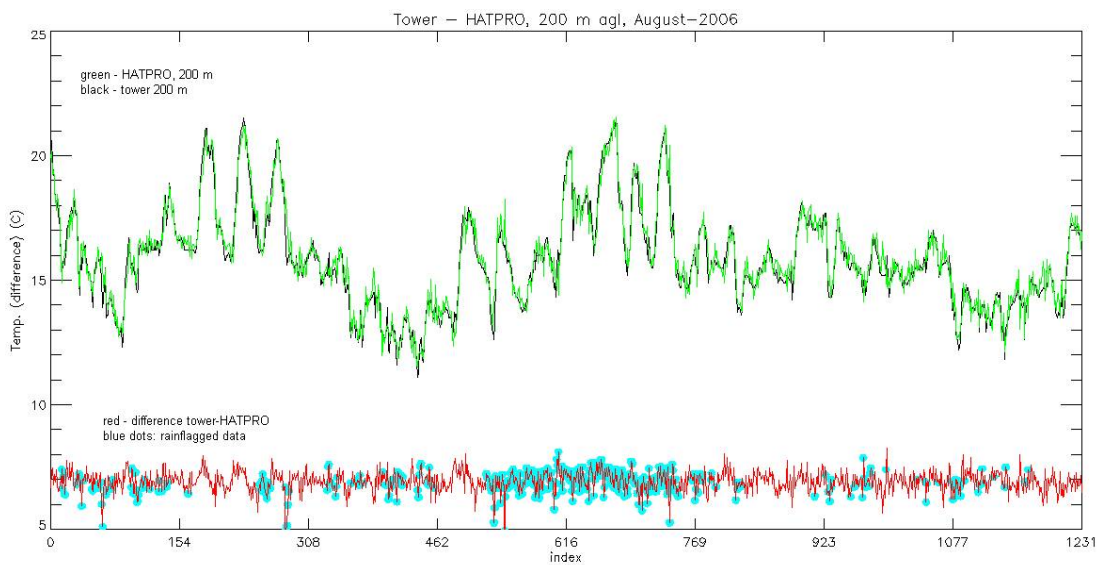

Fig.11: Comparison of retrieved HATPRO temperature at 200 m (green) with 200 m temperature sensor reading of met. tower (black) in Cabauw (KNMI) in August 2006. Total number of samples: 1232, no-rain: 836 samples (RMS: 0.36 K, bias: -0.04 K); 396



rain samples (RMS: 0.45 K, bias: -0.13 K). Rain samples are indicated as blue dots, rain rates are between 1 mm/h (drizzle) and 25 mm/h. BLM data remains accurate.

C2.6 Extreme Inversions

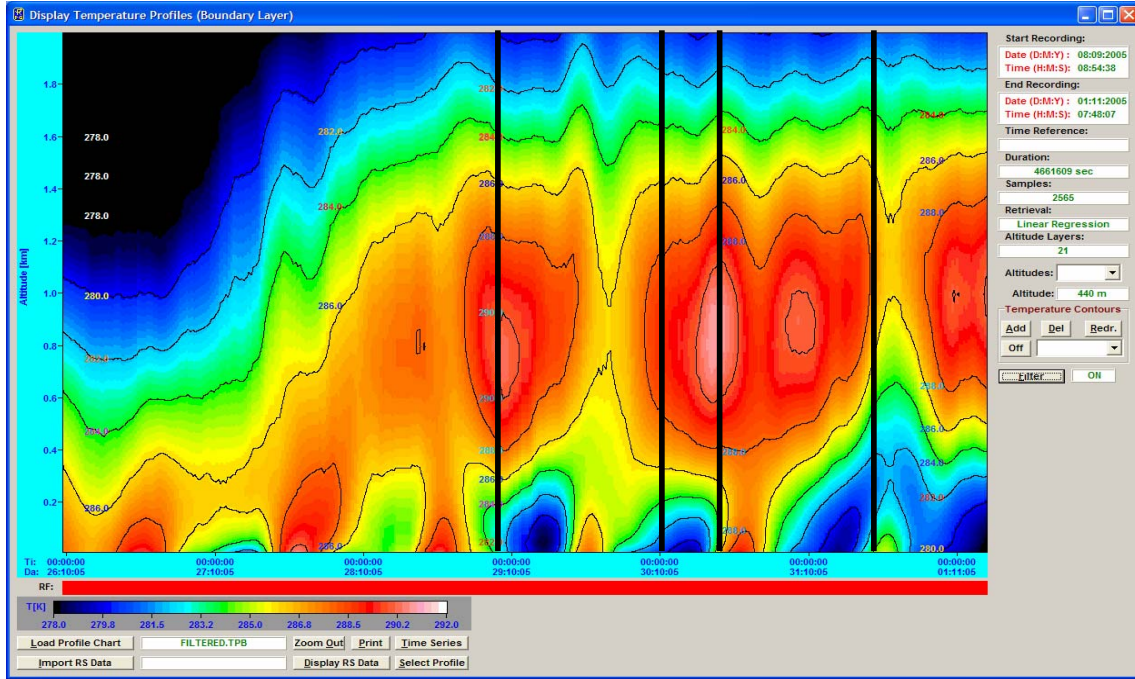

Fig.12: BLM map of one week period. Very strong inversions occurred in the second half of the period indicated by the black lines (Lindenberg, October 2005, courtesy of Univ. of Munich).

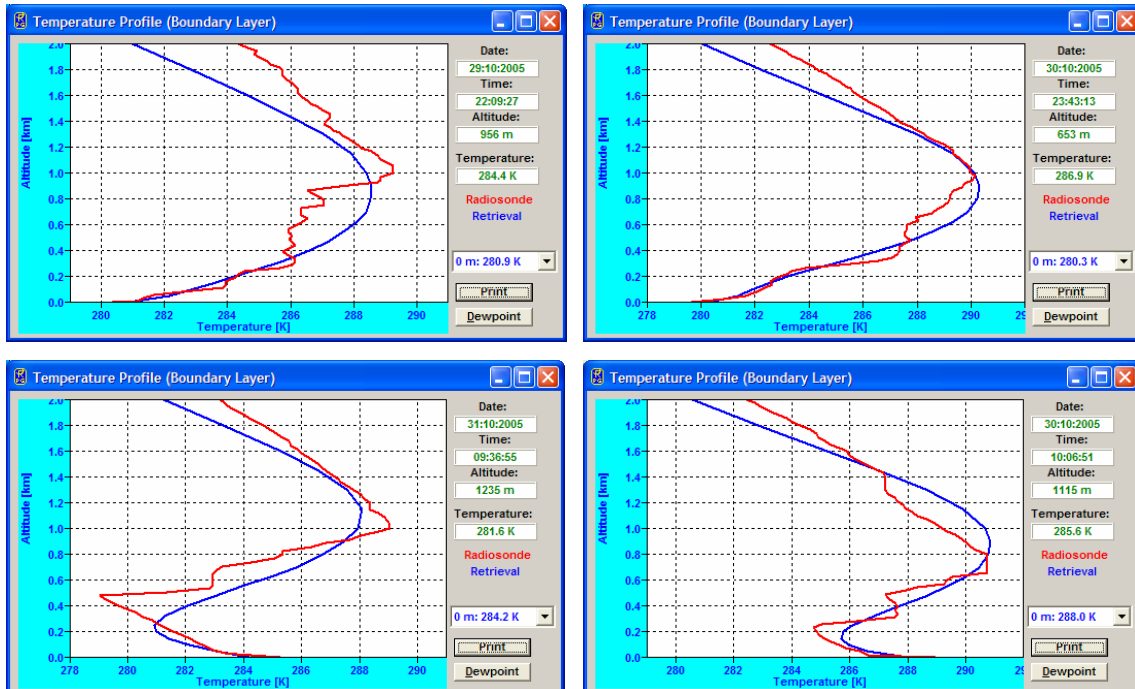

Fig.13: Inversion comparisons between radio sounding (red) and HATPRO BL mode observations (blue) for the four cases in fig.10 indicated by the black lines.

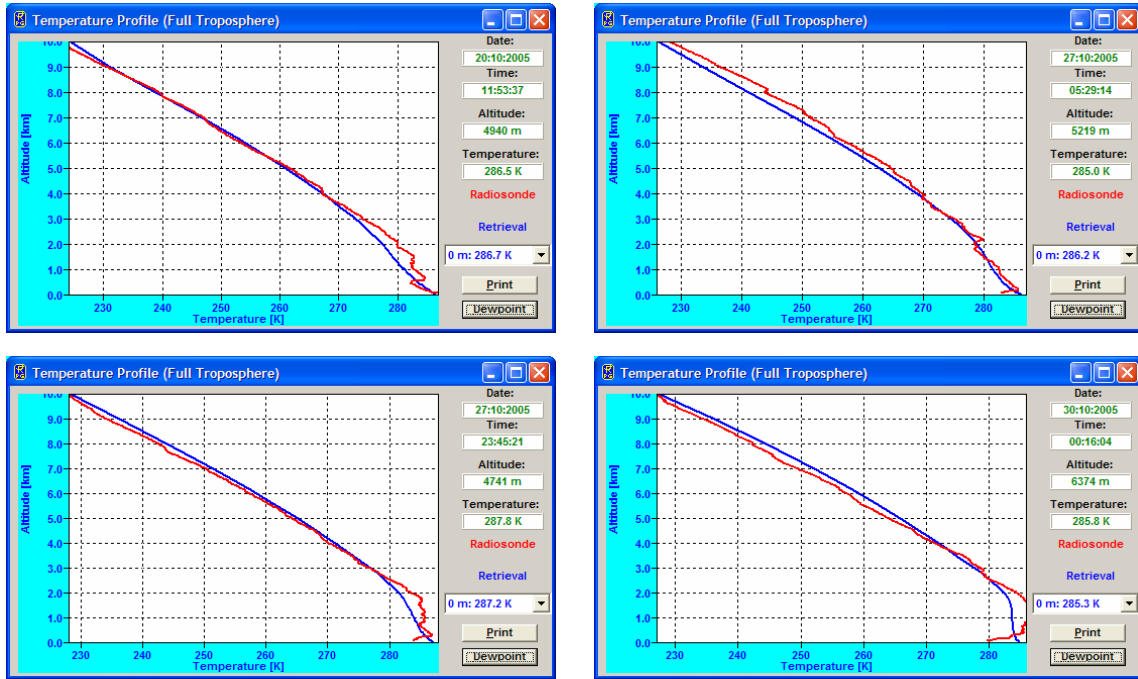

Fig.14a: Examples of comparisons between radio sounding (red) and HATPRO Z mode observations (blue). The boundary layer details are not always accurately resolved.

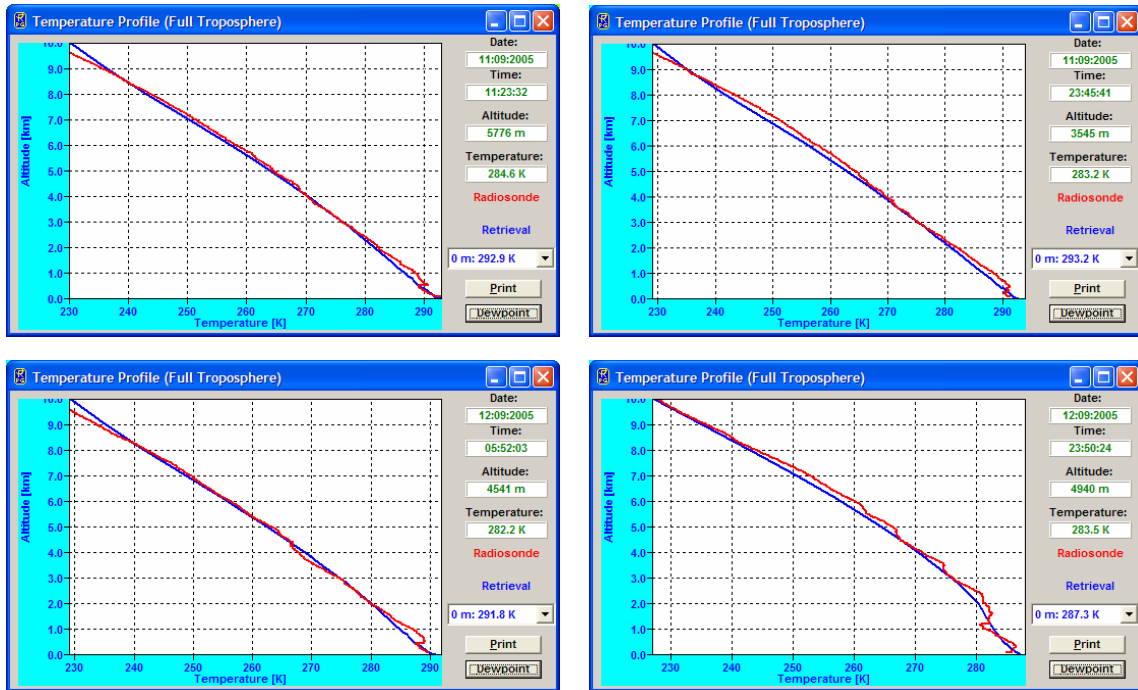

Fig.14b: The Z mode tends to smear out (average) the details of the boundary layer.

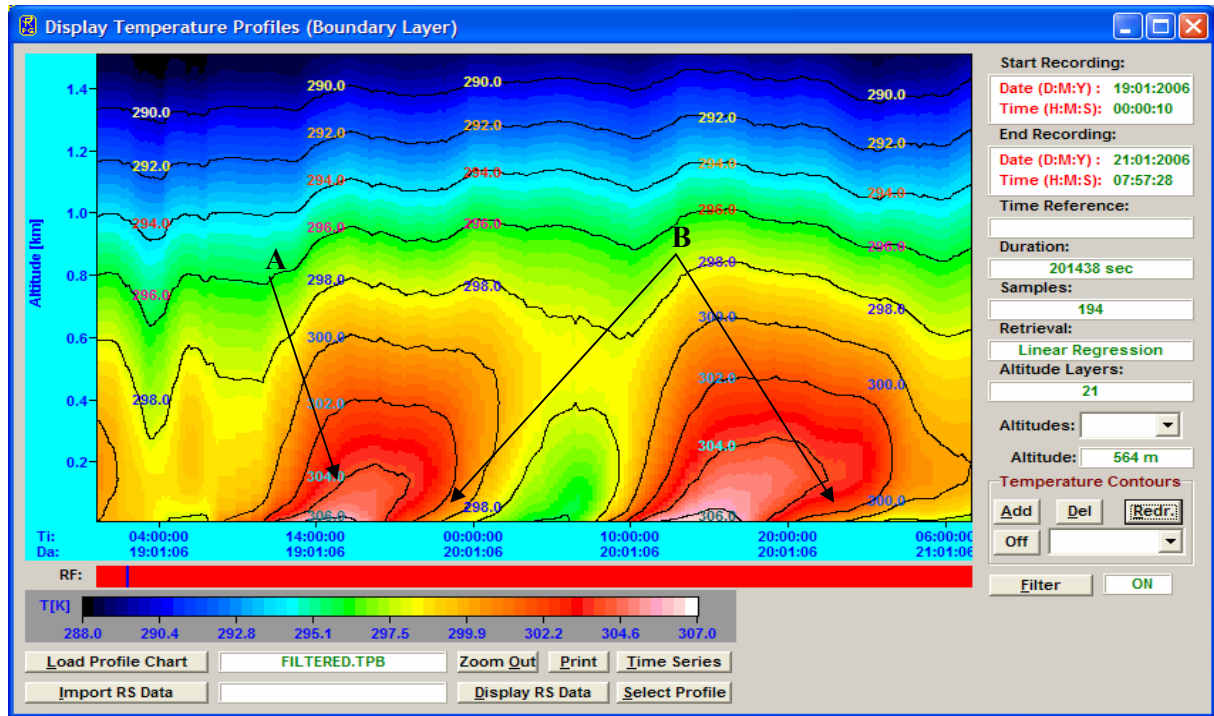

Fig.15: Strong solar heating (A) at day time and radiation cooling over night (B) (inversions!) during the AMMA campaign, January 2006, Benin / West Africa.

C3. Humidity Profiling

There is only a zenith mode for humidity measurements because at the water vapour line channel frequencies around 22 GHz the atmosphere is transparent. No saturation of the brightness temperatures occurs even at very low elevation angles like for the oxygen line center. Consequently an elevation scanning mode will not give significantly more information than the zenith mode. Nevertheless more accurate relative humidity profiles in the boundary layer can be generated by combining absolute humidity profiles with boundary layer temperature profiles and computing the relative humidity from these two profile types.

The microwave signals the radiometer observes are directly proportional to the absolute humidity above the instrument with offsets due to liquid water introduced by clouds. Consequently, for retrieving humidity by observations of the water vapour line, absolute humidity profiles (humidity measured in g/m^3) are the most 'natural' type of humidity profiles.

Relative humidity profiles can be generated in two ways:

- 1) Using directly a retrieval for relative humidity without taking into account any temperature profile information.
- 2) Using a retrieval for absolute humidity and combine this information with temperature profiles generated by zenith and boundary layer modes.

Both methods suffer from severe inaccuracies at high altitude (>5000 m) where the absolute humidity is so low (due to low temperatures) that the microwave detection of this contribution becomes impossible. But method 2 has advantages over method 1 in the boundary layer



because the higher accuracy and resolution of the boundary layer temperature profiles can be exploited for relative humidity profiling.

C3.1 Examples of Absolute and Relative Humidity Profiles

C3.1.1 RPG-HATPRO Measurements

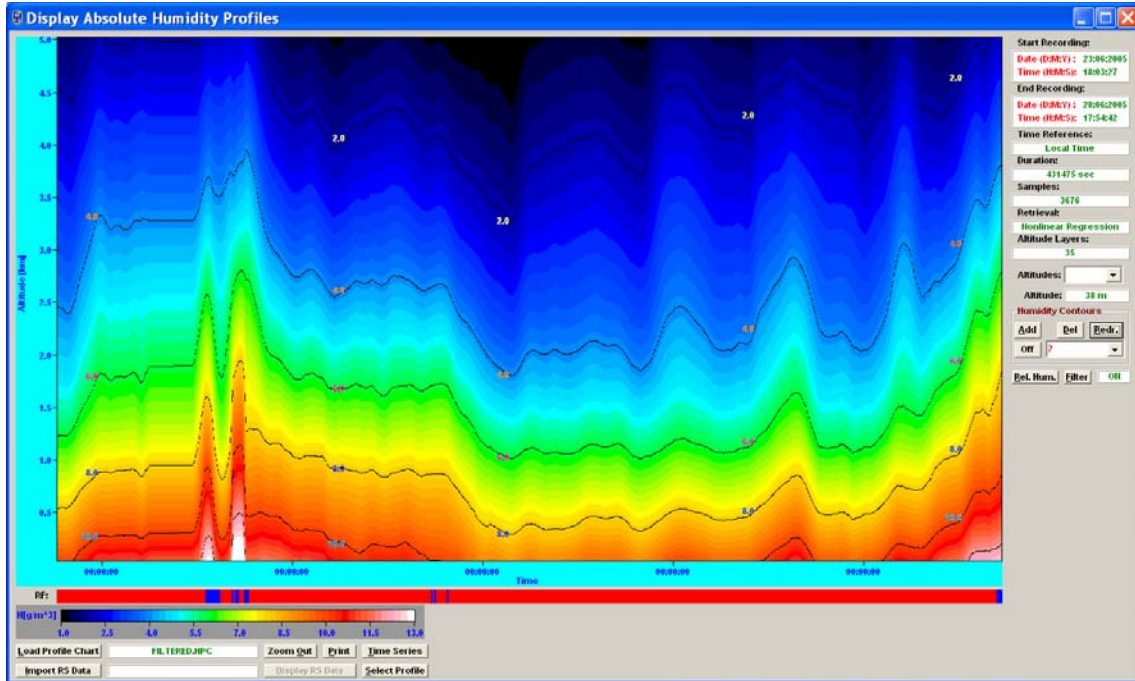

Fig.16: Absolute humidity profile map for a 5 day period.

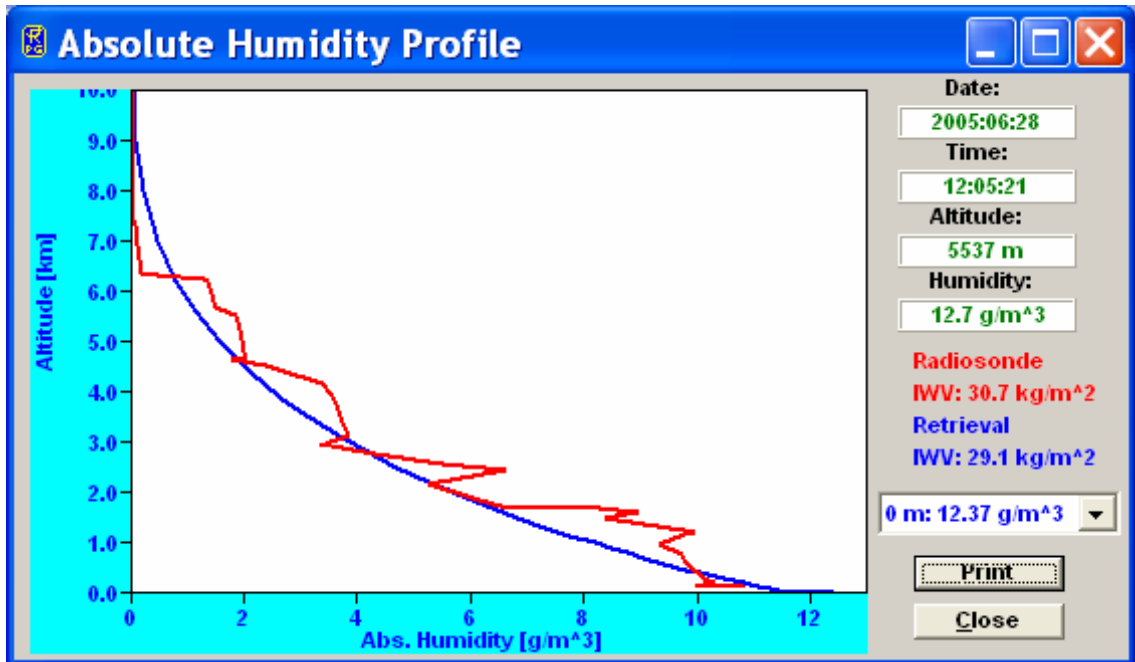

Fig.17: Sample profile taken from the map in Fig.16 at 12:00 UTC (noon time). In red is the data of a radiosonde for comparison (Larkhill, UK).

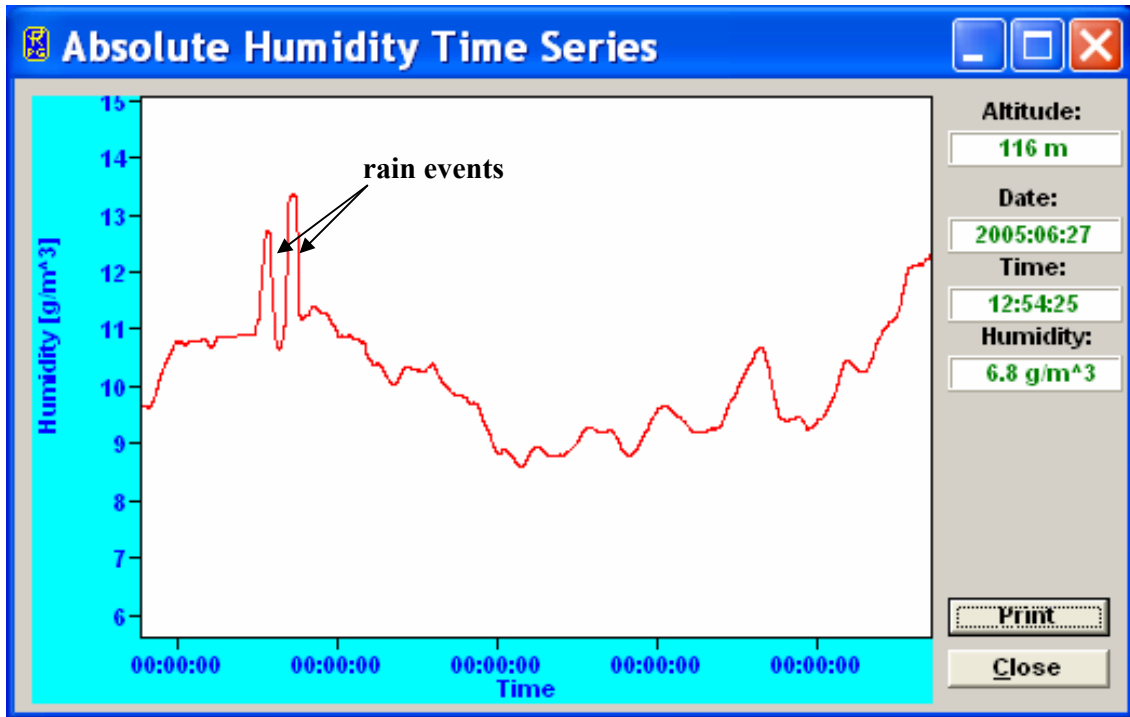

Fig. 18: Absolute humidity time series at 116 m altitude.

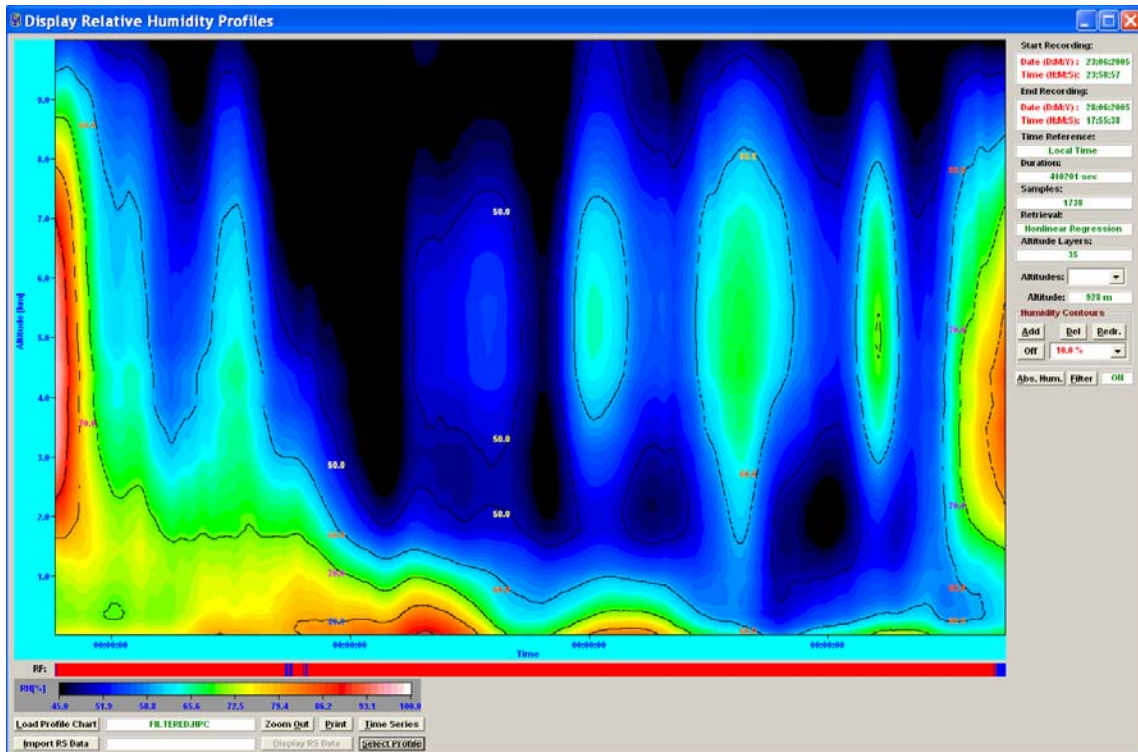

Fig.19: Relative humidity map for the full troposphere (up to 10 km) computed from absolute humidity profiles and temperature profiles both measured in zenith mode.

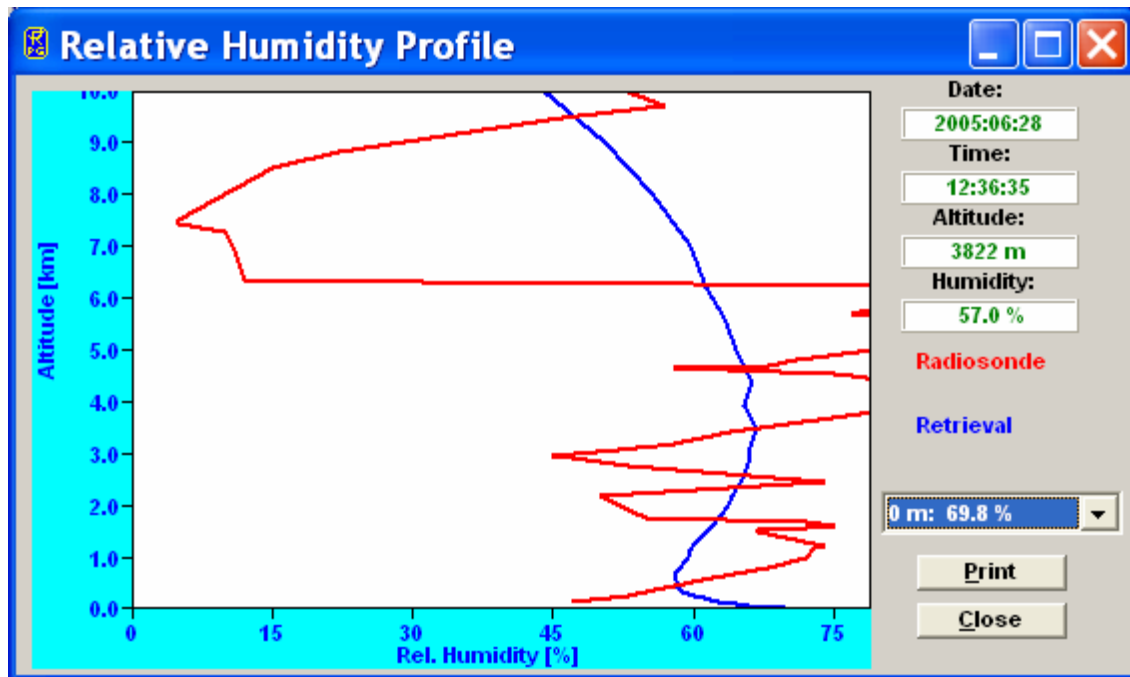

Fig.20: Comparison of relative humidity profile with radiosonde data. As mentioned above the microwave information does not allow for retrieving any details of humidity profiles above 5-6 km. A small error in absolute humidity at low temperatures produces a big error in relative humidity.

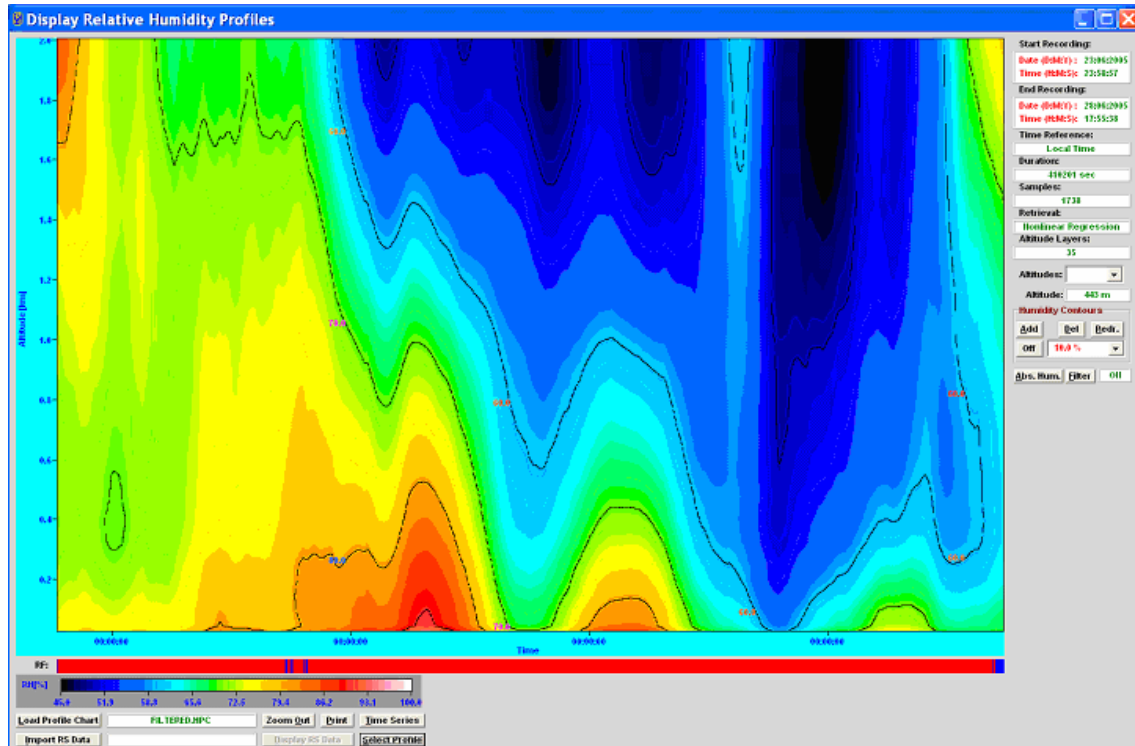

Fig.21: The lowest 2000 m layer map of Fig.11 computed from absolute humidity profiles and temperature profiles both measured in zenith mode.

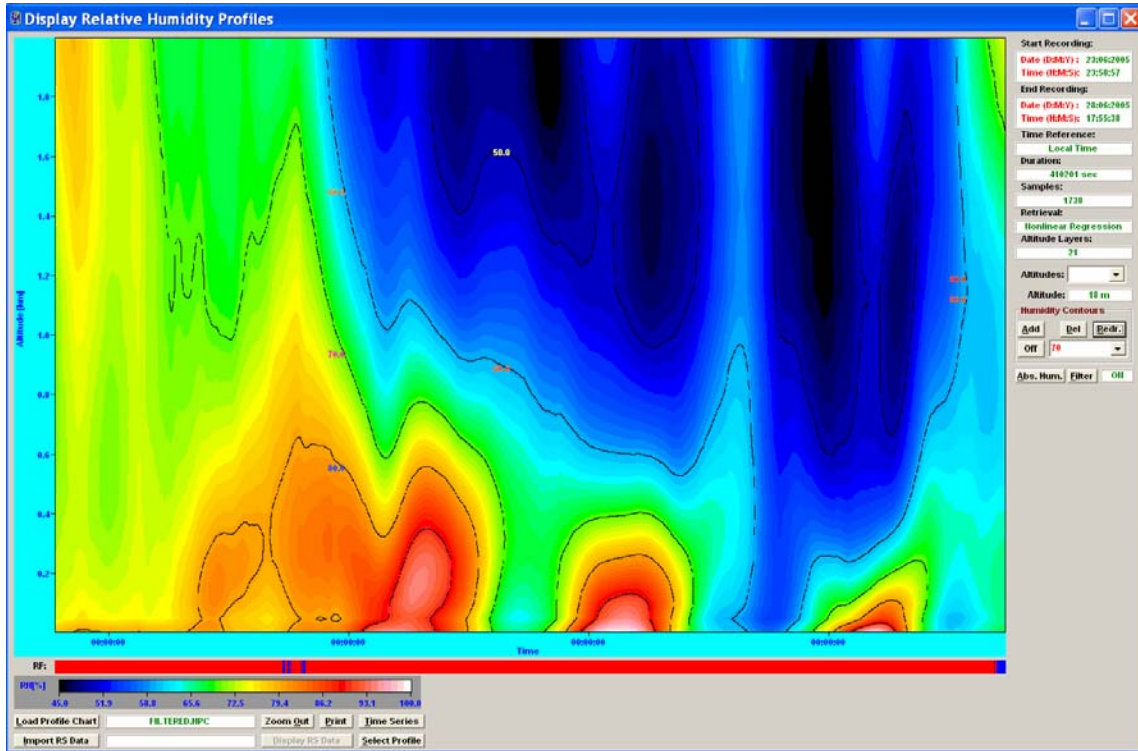
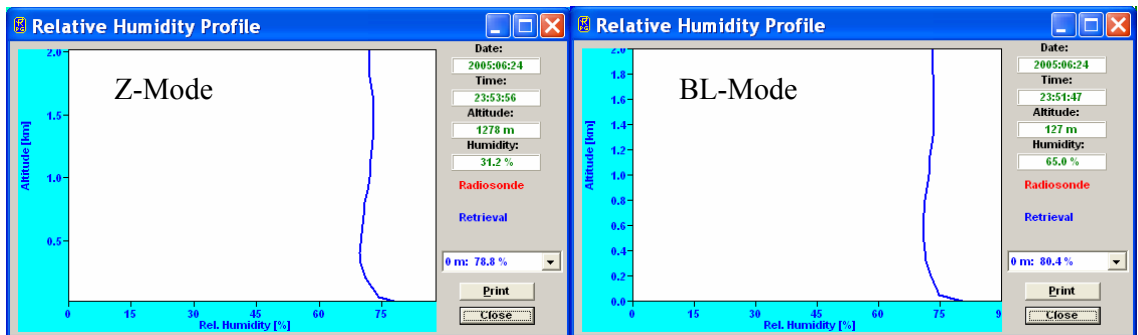

Fig.22: Relative humidity map for boundary layer (up to 2 km) computed from absolute humidity profiles and temperature profiles measured in boundary layer mode. A comparison with Fig.13 clearly shows that more details are resolved in the <500 m range. The relative humidity is modulated by the temperature inversions.

Below is shown a sequence of boundary layer humidity profile samples taken from Fig.21 (left profiles, Z-Mode (zenith mode)) and from Fig.22 (right profiles, BL-Mode (boundary layer mode)): Without temperature inversion the humidity profiles look almost the same.





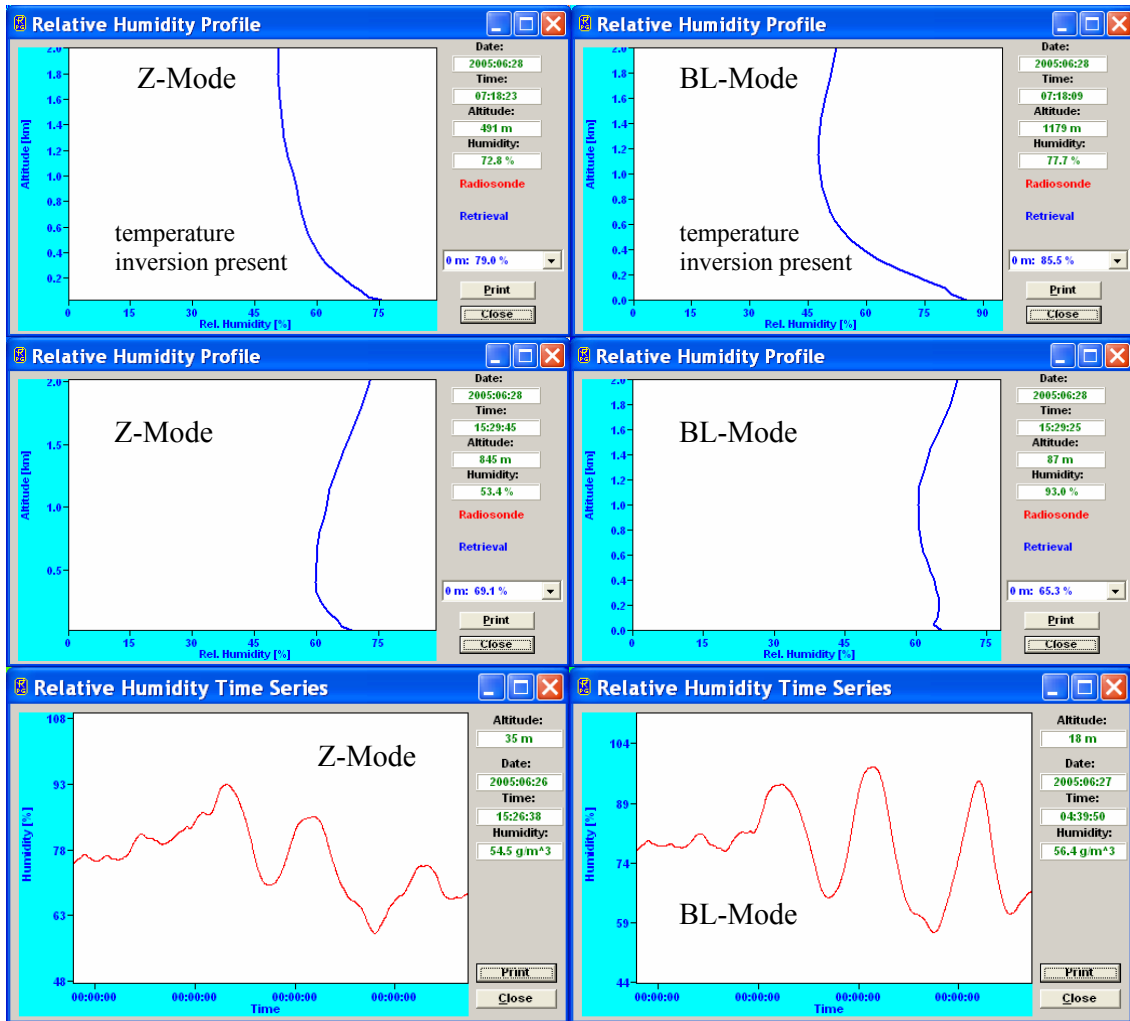

Fig:23: Relative humidity time series at low altitude measured in Z-mode and BL-mode. The BL-mode humidity maxima over night between 22:00 and 7:00 (when inversions are generated) are more pronounced than in Z-mode.

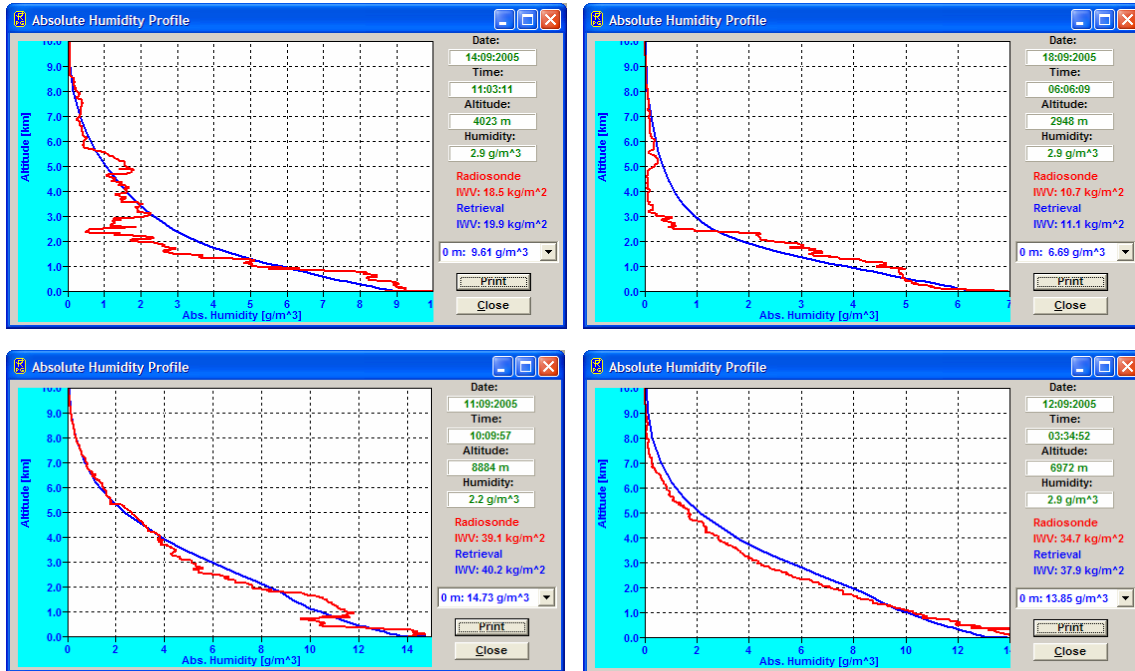

Fig:24: Absolute humidity profiles compared to radio soundings (red). Statistical analysis leads to RMS errors of 1 g/m³.

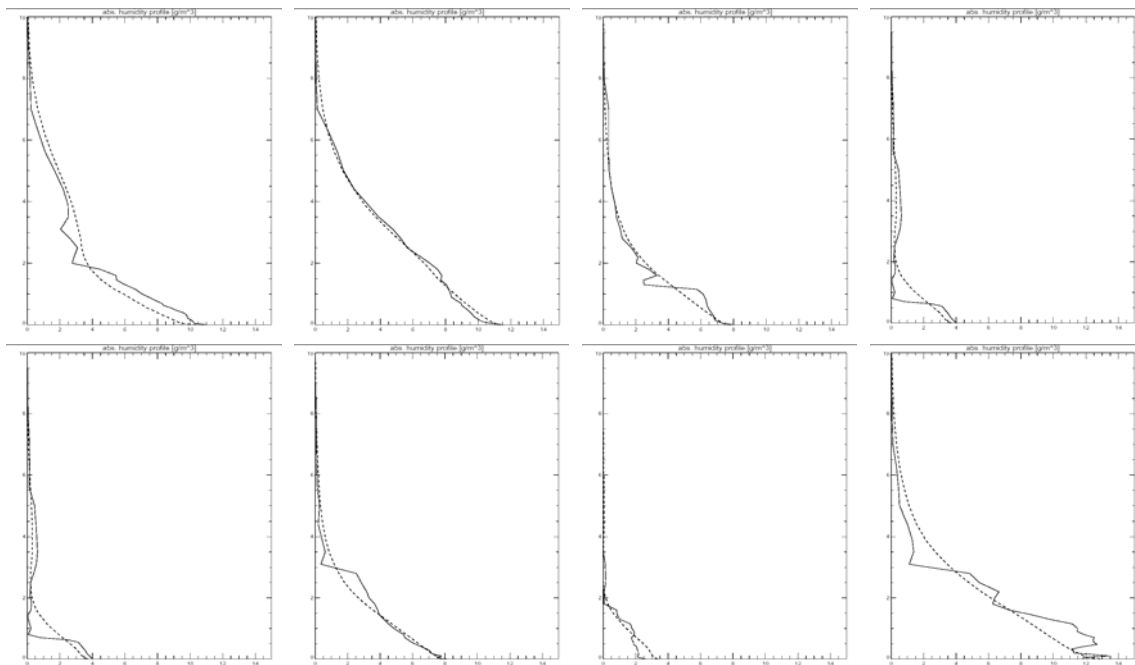

Fig:25: Due to the small number of degrees of freedom in the 22.4 GHz water vapour line the retrieval (dotted line) can only average through the real profiles but the integrated water vapour (IWV) measurement is quite accurate.

AMMA campaign, Benin / West Africa (Jan. 2006 to Jan. 2007)

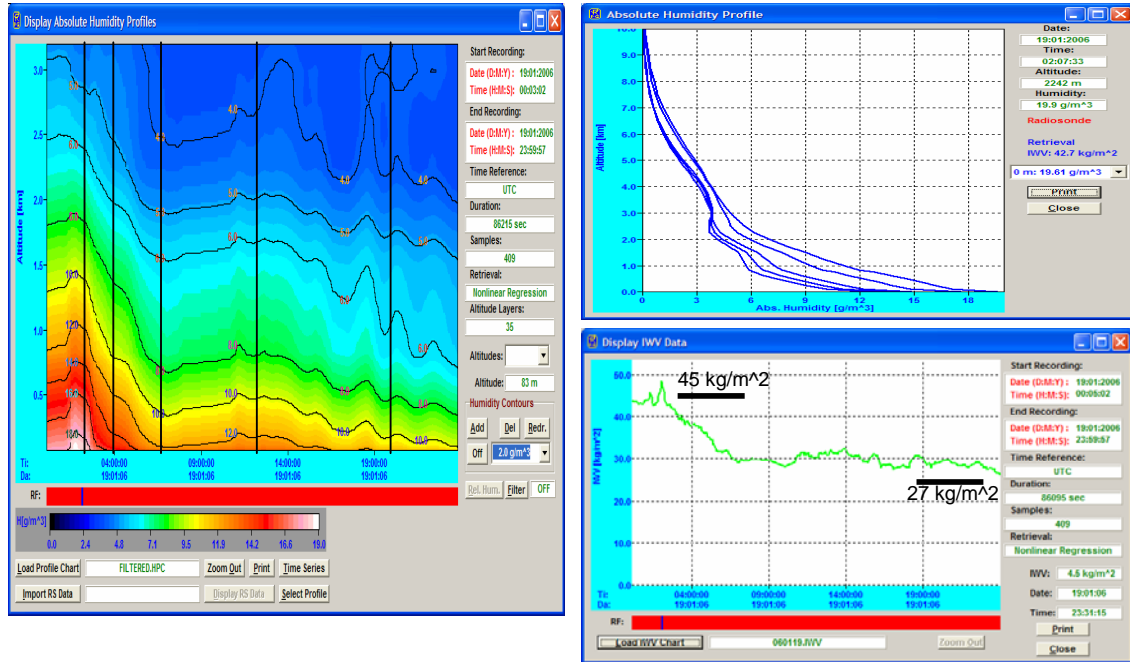

Fig.26: Example of a transition from wet to dry period by sea breeze effect in Benin / West Africa with development of absolute humidity profiles and integrated water vapour.

Morioka campaign, Japan (Oct. 2006 to Jan. 2007)

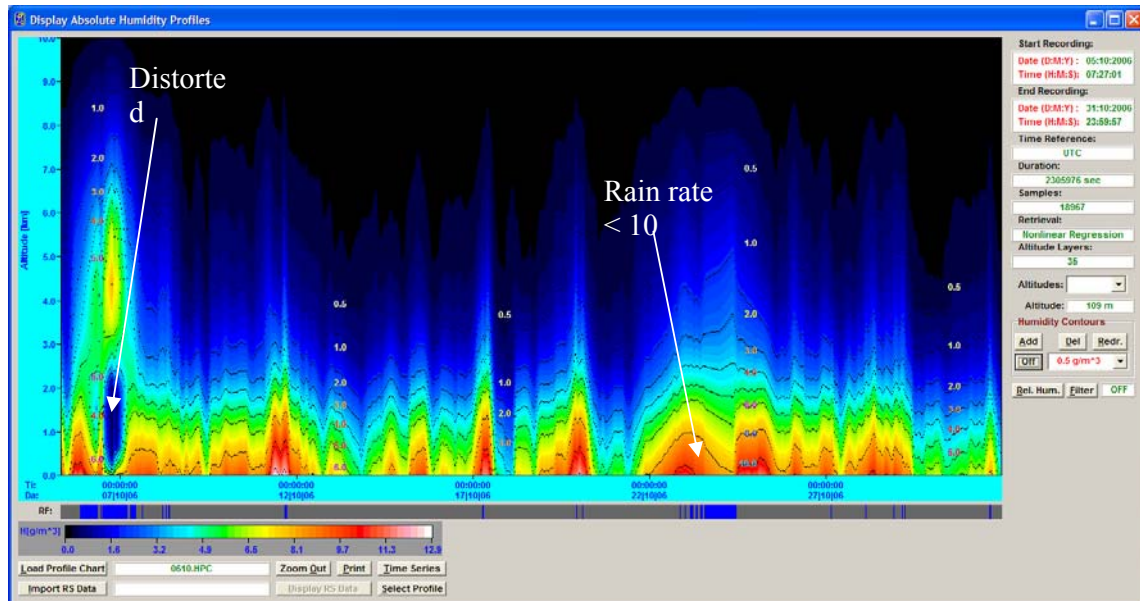

Fig.27: One month of absolute humidity data from Morioka / Japan. At rain rates >10 mm/h the profile is distorted while at rates < 5mm/h the profile accuracy is reduced by only 20%.

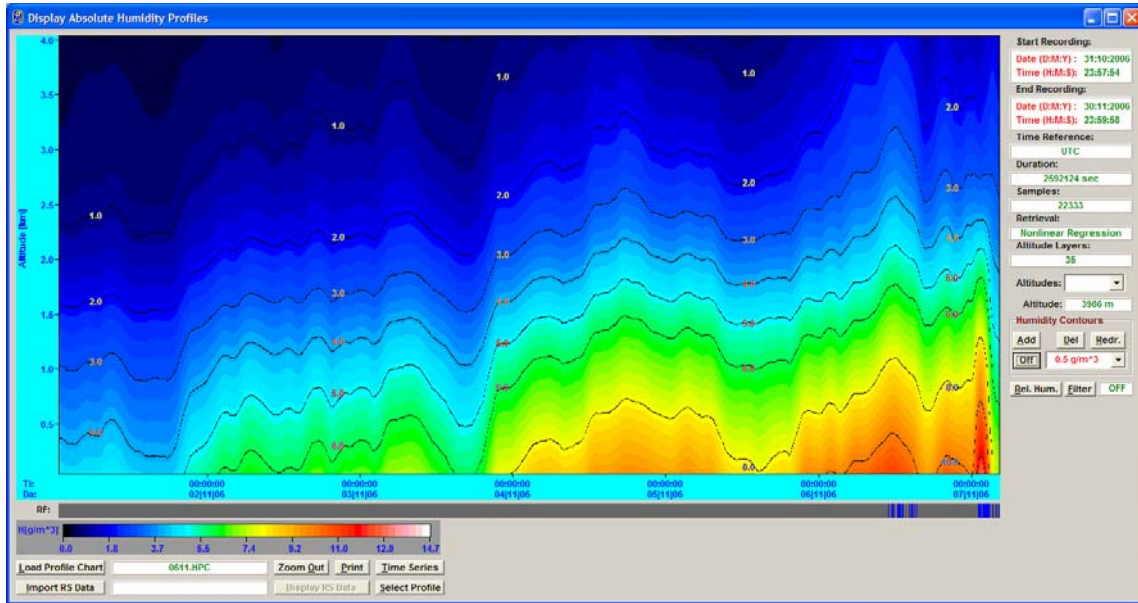

Fig.28: Absolute humidity profile map of the lowest 4000 m over 6 days.

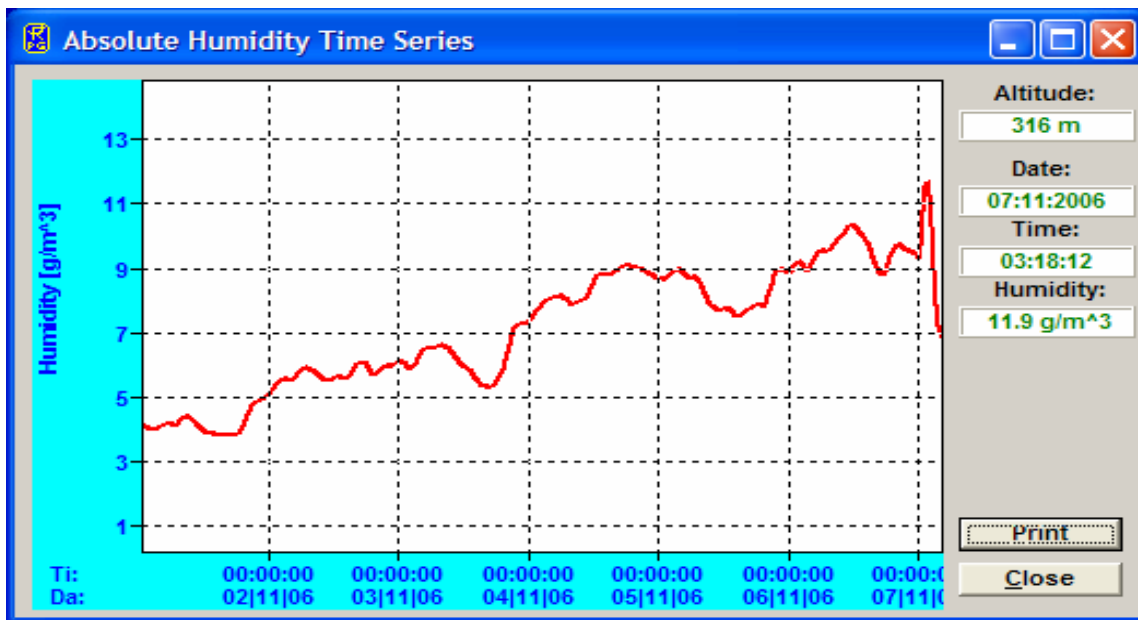

Fig.29: Absolute humidity time series @ 300 m level from period in Fig.28.

C3.1.2 RPG-LHATPRO Humidity Profiling

The same profiling observation modes as used for temperature profiles (BL and zenith) can be applied to humidity profiling with the 183 GHz line. Also the oxygen line channels are included in the humidity retrieval which is essential for resolving low altitude humidity inversions and relative humidity profiles. First results of radiative transfer calculations indicate the following vertical resolution and accuracies:



- Full troposphere humidity profiles (0-10000 m): 500 m (<4000 m altitude), 1000 m above, profile accuracy: +/- 0.02 g/m³ RMS (0-1000 m), +/- 0.04 g/m³ RMS (>2000 m)
- Boundary layer humidity profiles (0-2000 m), 100 m vertical resolution, profile accuracy: +/- 0.03 g/m³ K RMS (<2000 m).

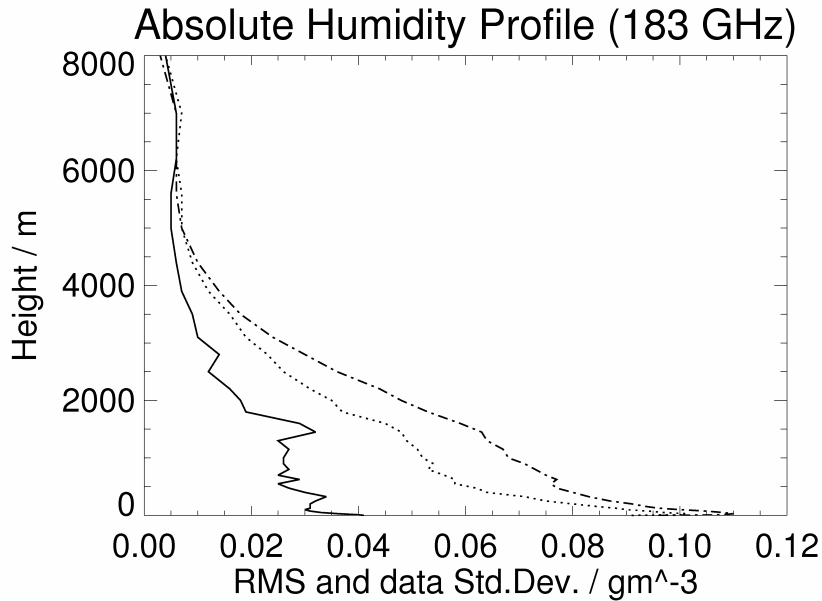
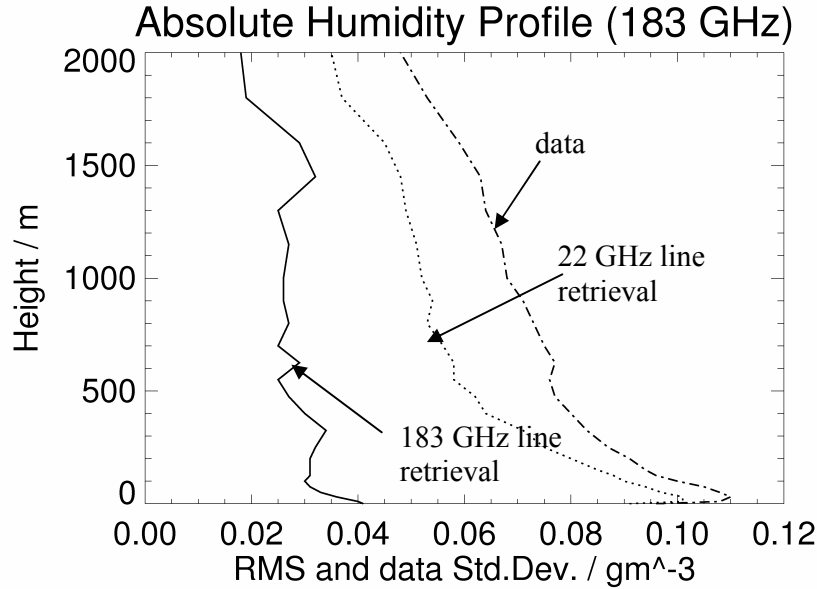

Fig.C3.1.2.1: Retrieval accuracy for humidity profiling with the 22 GHz and 183 GHz water vapour line.

For the IWV retrieval the following accuracies are expected at very low humidity levels like at DOME C (Antarctica):

IWV at Dome C

Natural variability (Std.Dev.): 0.189 kg/(m²)

retrieval with 183.31 GHz line: RMS=0.008, Correlation=0.999



LWP accuracy is about 10-20 g/m² with RMS noise of 5 g/m².

Retrieval Performance at Dome C / Antarctica

Based on the radiosonde data from the Concordia station (290 soundings from 2006), we calculated the microwave brightness temperatures (BT) for down-welling radiation at several elevation angles. By adding instrument noise (0.5 Kelvin RMS) we obtained a synthetic radiometer measurement. A multi-variate quadratic (sometimes only linear) regression established the inversion of forward-calculated brightness temperatures to atmospheric parameters.

Only 80% of the data (randomly chosen) were used for the regression, the rest were used for algorithm testing. The following algorithm performance estimates are based on the application of the regression methods on the unused 20% of the data. All results are preliminary. At a later stage, we will incorporate more data, maybe from Scott base or other similar locations.

Integrated water vapour

The total column water vapour is very low at Dome C. The brightness temperatures of the 22.235 GHz water vapour line are much too small for water vapour retrievals in low pressure and at very cold climates. We compare the retrieval performance of a sounder with 6 double-side-band channels around 183 GHz with the performance of a standard radiometer for mid-latitudes with 7 channels between 22.24 GHz and 31.4 GHz.

The 22 GHz system has a low information content in the BT, thus the retrieved IWV is basically the all-year mean value plus some scatter around it.

For the IWV retrieval the following accuracies are expected:

Natural variability (Std.Dev.): 0.189 kg/(m²)

retrieval with 22.235 GHz line, RMS=0.140, Cor=0.583

retrieval with 183.31 GHz line, RMS=0.008, Cor=0.999

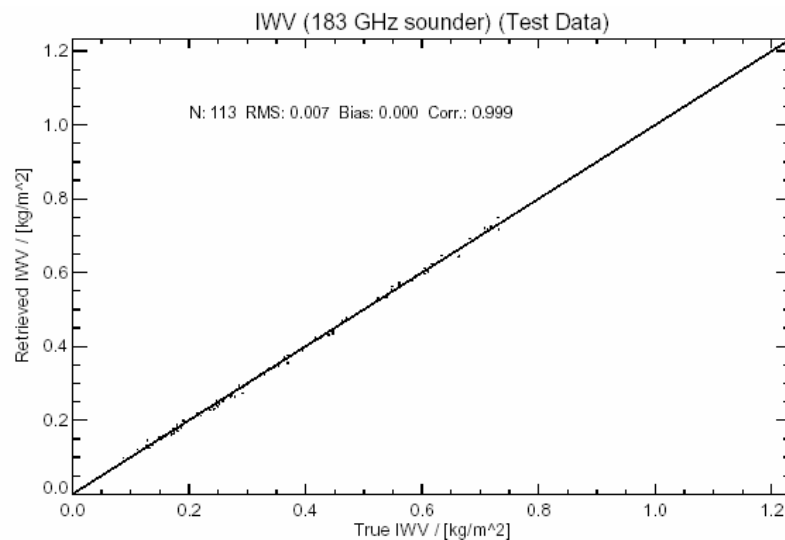

Fig.C3.1.2.2: IWV scatter plot.

Humidity profiles with 183 GHz WVL:

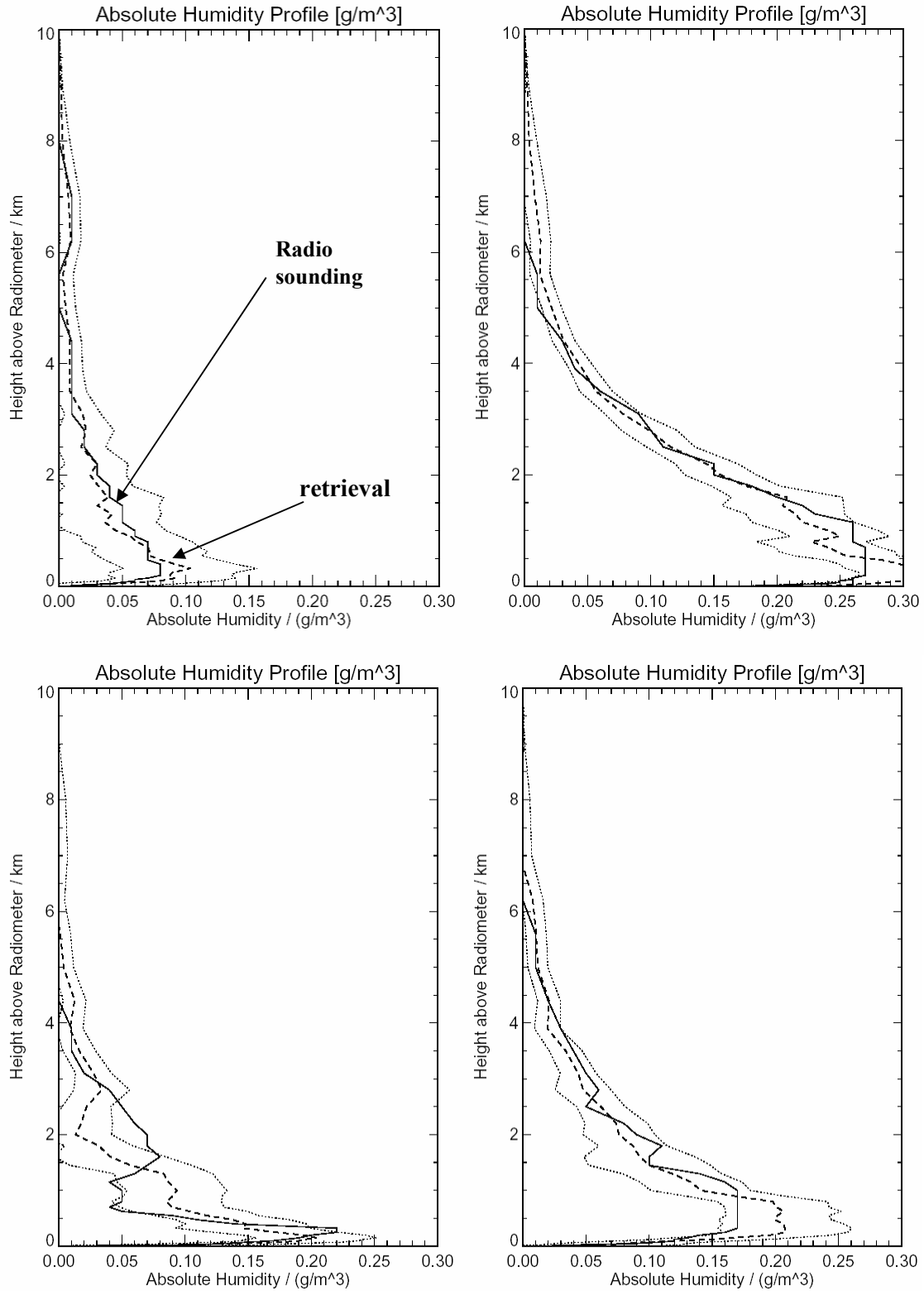

Fig.C3.1.2.3: Humidity profiling retrieval accuracy.

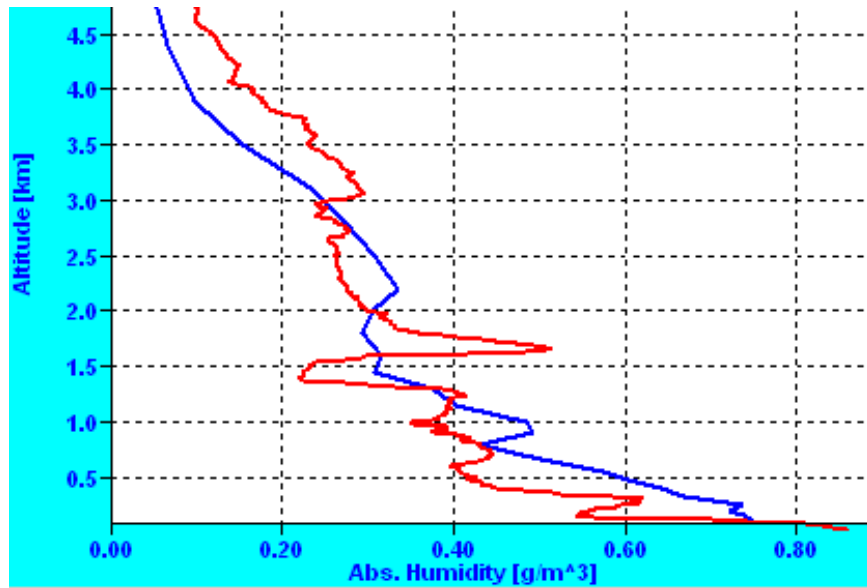

Fig.C3.1.2.4: Humidity profile comparison from Pic du Midi (French Pyrenees), courtesy of CNRS, Laboratoire d'Aerologie, Observatoire Midi-Pyrenees .

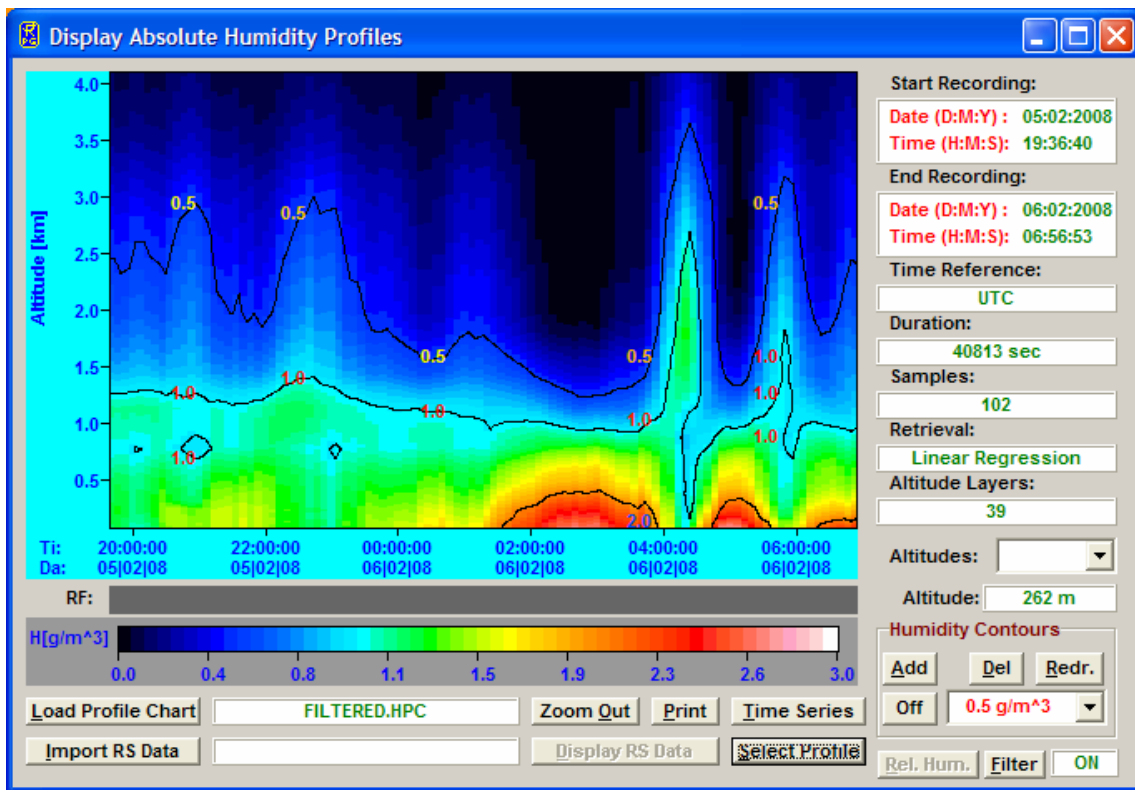

Fig.C3.1.2.5: Example of humidity profile chart from Pic du Midi (French Pyrenees), courtesy of CNRS, Laboratoire d'Aerologie, Observatoire Midi-Pyrenees .

C4. LWP and IWV Measurements

The RPG-HATPRO is capable of measuring liquid water path (LWP) with a 1 second temporal resolution due to its parallel receiver architecture. The variability of clouds can be



analyzed in detail also because of the relatively narrow beam width of 4° HPBW (half power beam width) for the water vapour channels.

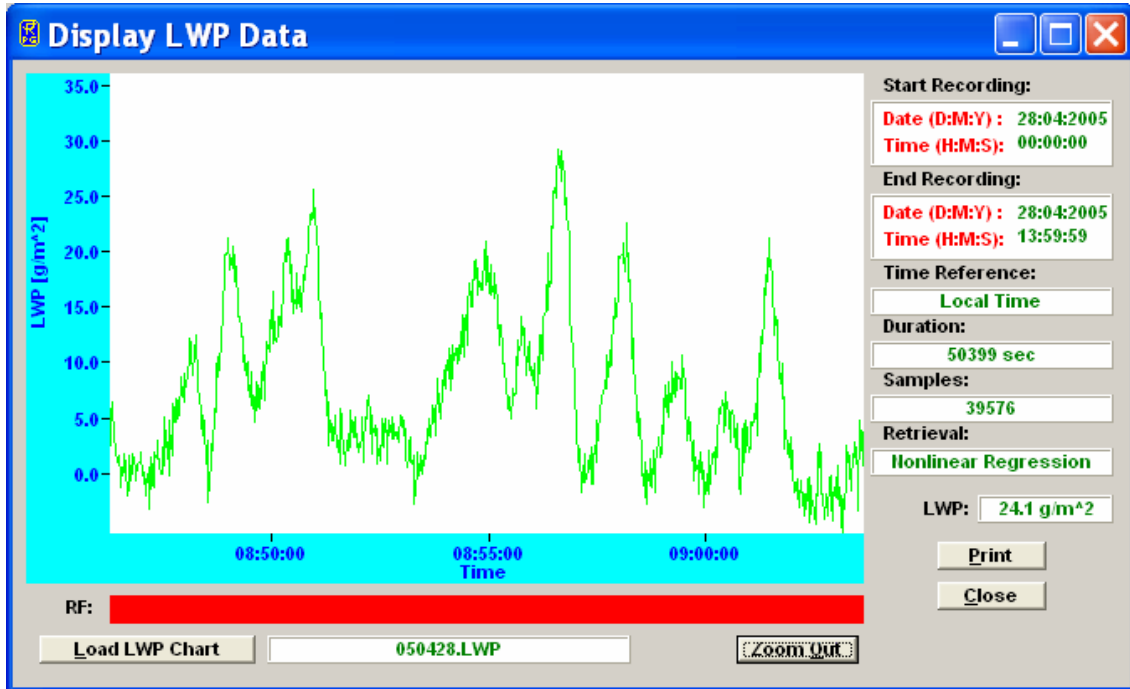

Fig.30: High temporal resolution (1 second sampling) LWP time series. The measurement noise is very low ($< 2 \text{ g/m}^2$ RMS).

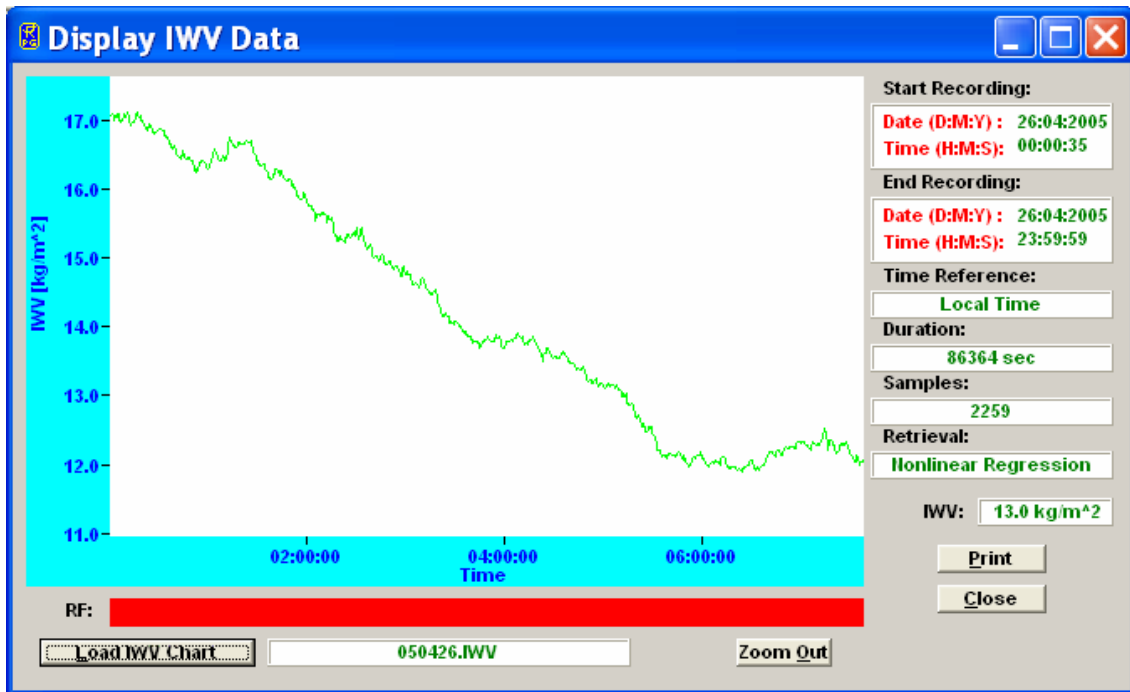

Fig.31: IWV time series. Absolute accuracy is $\pm 0.3 \text{ kg/m}^2$ with an RMS noise of $< 0.05 \text{ kg/m}^2$.



The LWP measurement noise is very low ($< 2 \text{ g/m}^2 \text{ RMS}$, see Fig.30), thus even thin clouds can be resolved.

For integrated water vapour measurements (see Fig.31) the temporal resolution is not important. A sample rate of 1/minute is sufficient to monitor all IWV details. IWV is the most accurately retrieved atmospheric parameter with an absolute accuracy of $\pm 0.3 \text{ kg/m}^2$ and an RMS noise of $< 0.05 \text{ kg/m}^2$.

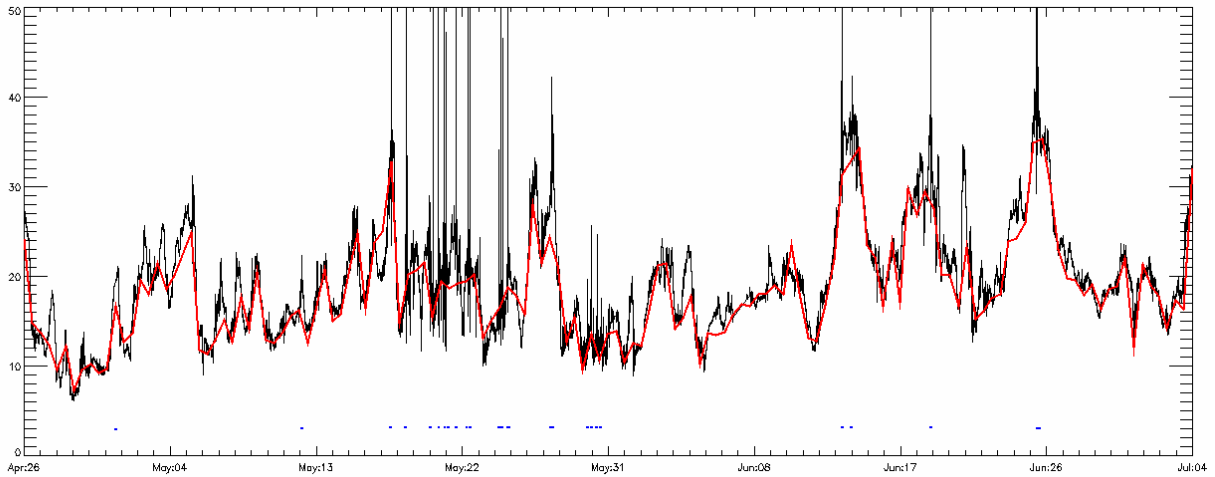

Fig.32: IWV time series over one month (KNMI, May 2006). 140 radio sondings (26. April to 4. July, Cabauw, KNMI). Radiosonds: Vaisala RS-92. No-Rain RMS: 0.43 kg/m^2 , Bias: 0.05 kg/m^2

C5. Stability Indices

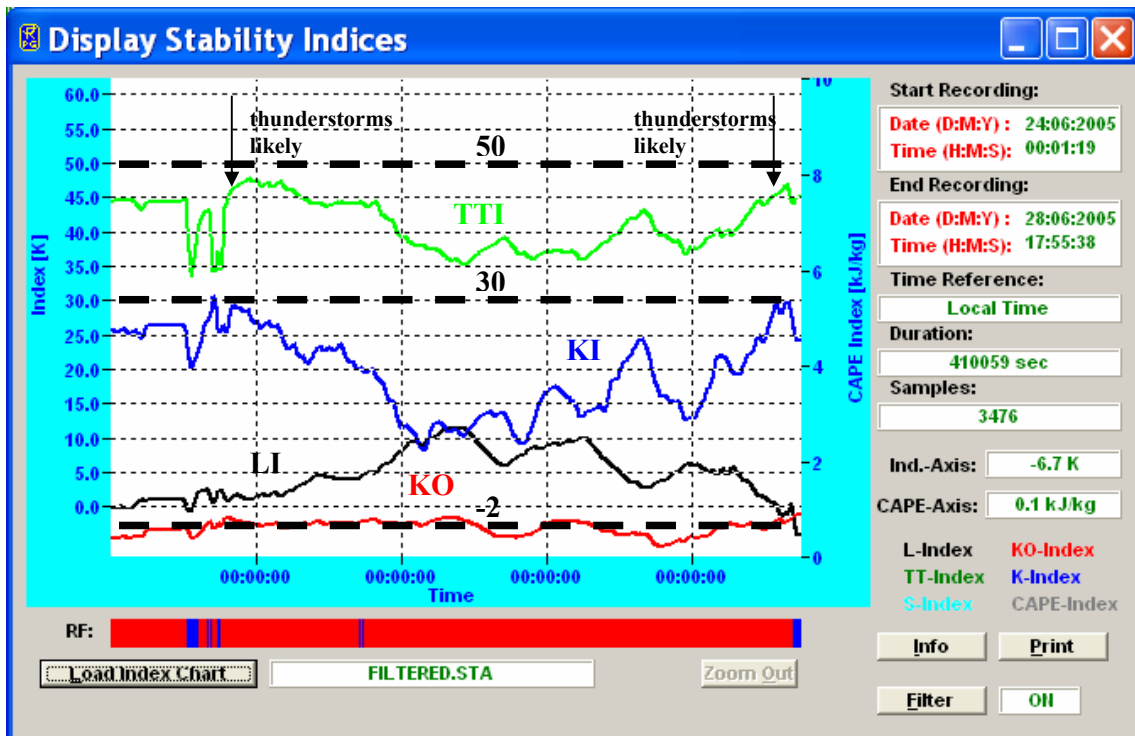

Fig.33: When TTI, KI and LI are approaching their critical limits, thunderstorms are likely to occur. This can be seen from the rain flag bar (blue indicates 'rain', red means 'no rain').

The RPG-HATPRO is delivered with retrievals for the most common atmospheric stability indices like:

- The Lifted Index (LI) shows the stability of an air parcel. It is computed by lifting the parcel of air pseudo-adiabatically to a 500 mb level, then comparing the temperature of the air parcel to that of the environmental air temperature. The temperature of the air parcel may be much higher than the surrounding air (e.g. due to condensation), causing it to be unstable in a sense that it wants to be displaced vertically. We look for negative numbers with this index. The more negative the number, the more unstable the air is and the more potential there is for a stronger thunderstorm. Values of zero or below are good indicator of general thunderstorms. Severe thunderstorms are possible when the values reach -4 or so.
- The Total Totals Index (TTI) combines the effect of the atmospheric lapse rate and low level moisture. It is computed by using the Cross Totals Index ($CT = Td_{850} - T_{500}$) and the Vertical Totals Index ($VT = T_{850} - T_{500}$). An index of 50 is a good starting point for thunderstorms.
- The K Index (KI) represents the thunderstorm potential as a function of vertical temperature lapse rate at 850 mb temperature and 500 mb temperature, low level moisture content at 850 mb dewpoint and the depth of the moist layer at 700 mb dewpoint (George, 1960). KI increases with decreasing static stability between 850 and 500 mb, increasing moisture at 850 mb and increasing relative humidity at 700 mb. KI can be used as an indicator of convection but not as a discriminator of severe versus non-severe convection. Values of $KI > 20$ generally represent a convective environment capable of producing scattered thunderstorms activity, while $KI > 30$ represents an atmospheric potential for numerous thunderstorms to occur (Haklander and Van Delden, 2003).

C6. Scanning

Scanning of IWV, LWP, water vapour field, temperature, and cloud coverage.

- In order to obtain sky scans, the radiometer needs (a) steerability, and (b) rapid integration (10 degree steps in azimuth and 9 degree steps in zenith result in 324 observations for one sky map).
- The RPG-HATPRO instrument has zenith scanning capabilities as a basic feature. The azimuth positioner is adding the second scan direction. The control of both angles for scanning is fully supported by the software.
- The RPG-HATPRO instrument can switch to a rapid scan mode with 0.4 s integration time. Adding some time for the movement of scan mirror (zenith) and positioning table (azimuth), one observation point can be acquired within 1 second, resulting in roughly 5 minutes for one hemispheric scan. Longer integration times would render the scanning capabilities for sky maps nearly useless, because the scan needs to be completed faster than the sky is changing it's pattern.

From the scanned data the software is automatically retrieving the directional dependent values for IWV, LWP, profile of absolute humidity, temperature profile, and cloud coverage. The software supports azimuth-zenith plotting.



Figure 34: A HATPRO instrument with azimuth positioner during full sky scan operation at the US ARM mobile facility.

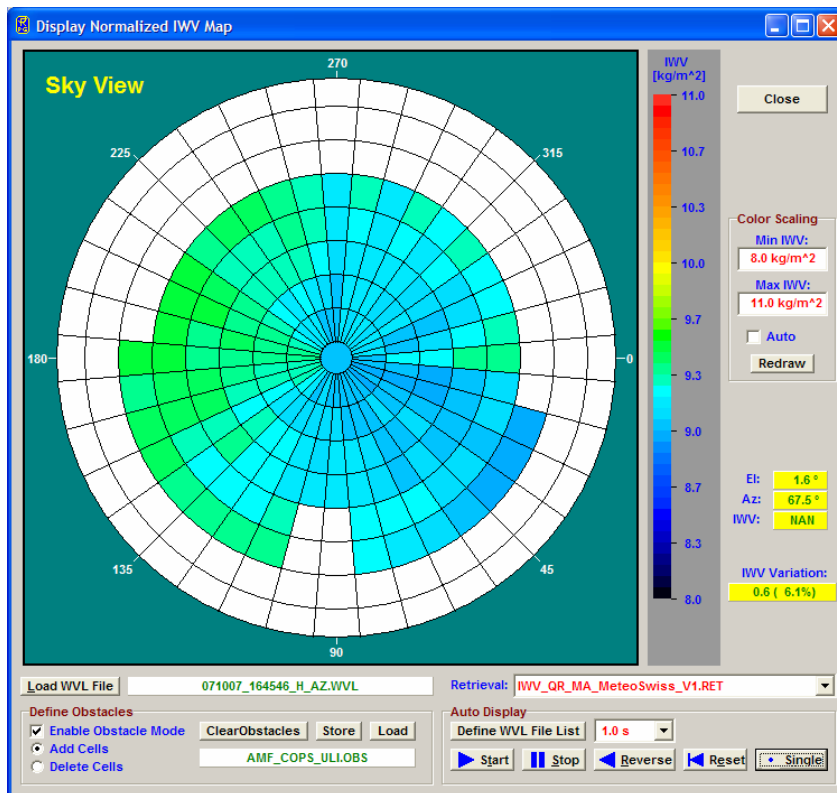

- Figure 35a: Normalized IWV map. The HATPRO software is fully supporting the sky scanning capabilities of the azimuth-scanned radiometer. Courtesy of U. Löhnert, Univ. of Cologne / Germany.

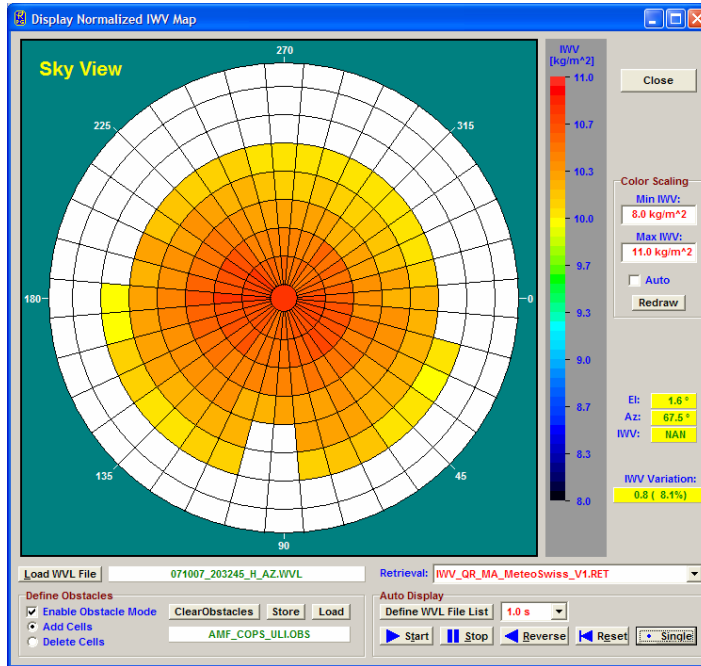

Figure 35b: Normalized IWV map. Humidity variations of up to 20% over the sky have been measured. Courtesy of U. Löhnert, Univ. of Cologne / Germany.

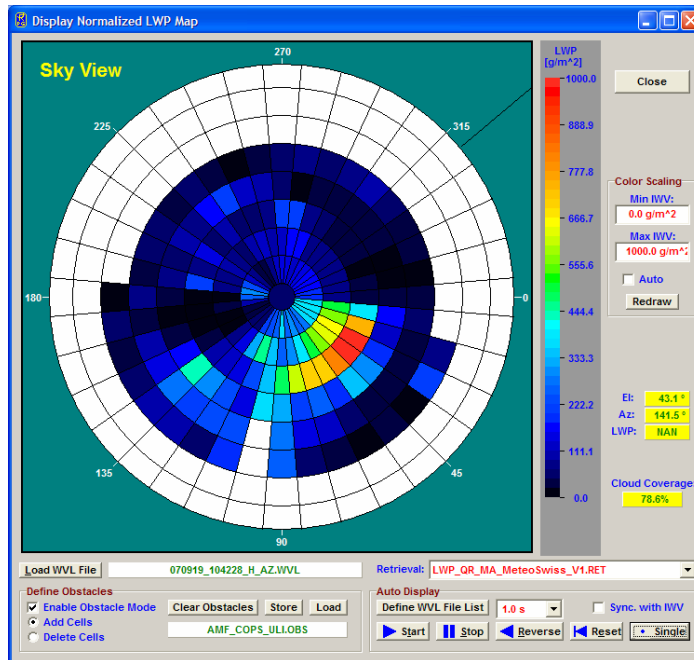

Figure 36: Normalized LWP map showing the cloud coverage and cloud thickness variations. Courtesy of U. Löhnert, Univ. of Cologne / Germany.

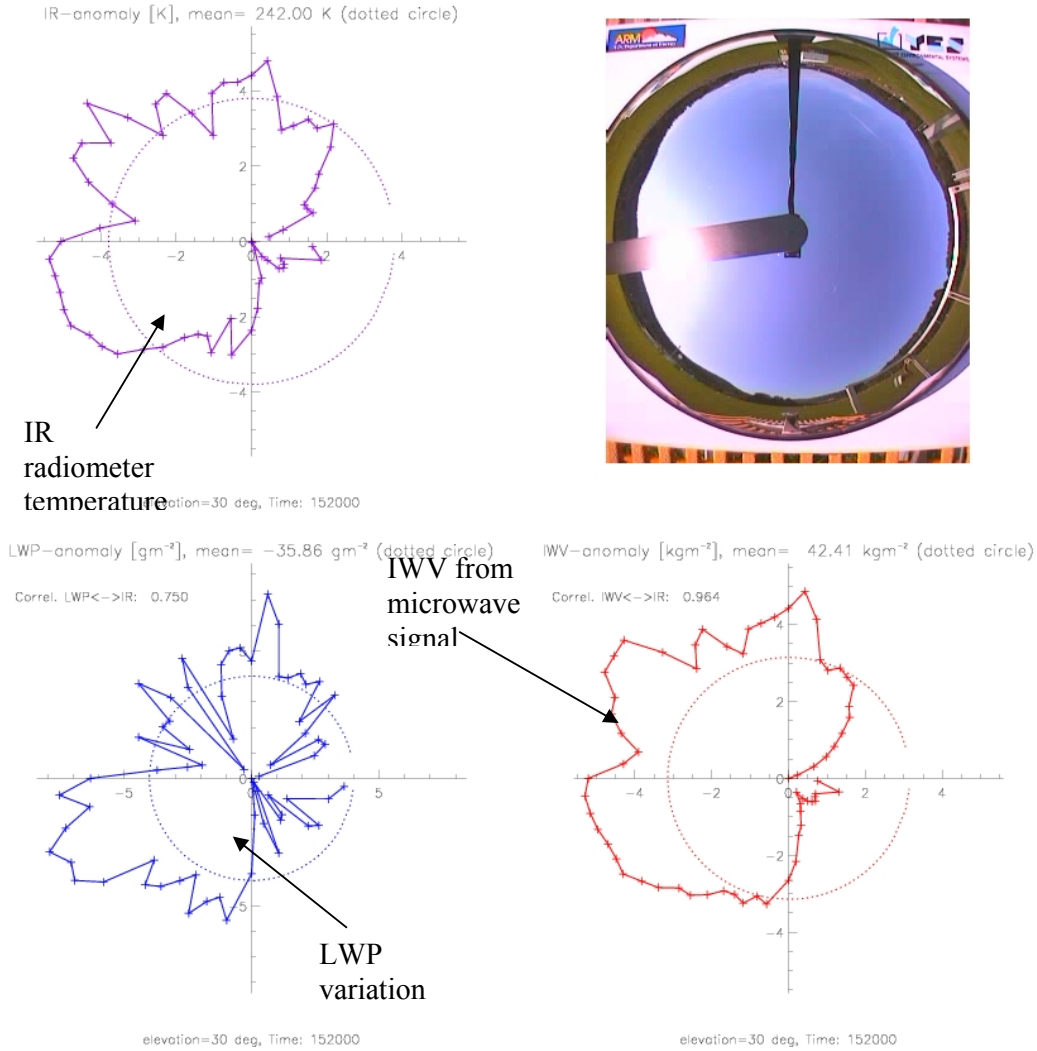

Fig.37: Azimuth scan under clear sky conditions. Displayed are the anomalies of IWV, IR radiometer temperature, LWP and optical camera (fish eye view). IR and IWV match nicely. The IWV variation is about 13% in this plot. Scanning azimuth pitch angle is 5°. A full scan takes 40 seconds. Courtesy of S. Kneifel, Univ. of Cologne and LMU Munich.

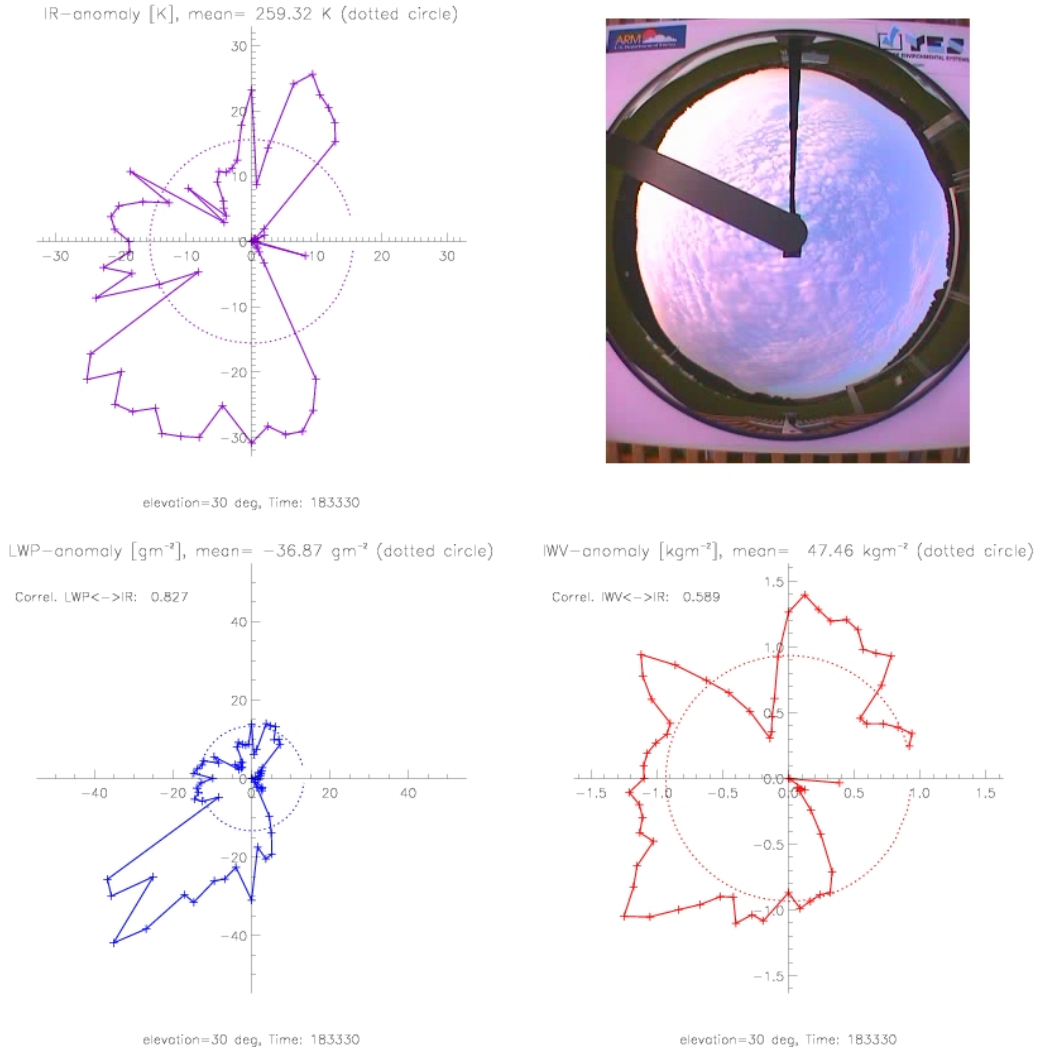

Fig.38: Under cloudy conditions, the IR radiometer signal is partially saturated while the microwave IWV is still reflecting the water vapour distribution. The IR gets saturated where the LWP level indicates clouds. Courtesy of S. Kneifel, Univ. of Cologne and LMU Munich.

C7. Acknowledgement

Data Sources:

1. CSIP (Convective Storms Initiation Project). The RPG-HATPRO instrument was run by the University of Salford who is a member of UFAM (Universities Facilities for Atmospheric Measurements).
2. LAUNCH campaign, University of Munich, Germany
3. AMMA campaign, University of Bonn Germany
4. Morioka / Japan, Japan Meteorological Agency
5. KMNI, Dutch Weather Service, Cabauw / Netherlands
6. CNRS, Laboratoire d'Aerologie, Observatoire Midi-Pyrenees



Appendix D (COMS.ADR File Adaptation)

The host software uses an RS-232 interface to communicate with the radiometer PC. The communication routines are accessing the interface via port addresses. If the serial interface is included in the host PC's mother board these addresses are predefined (from the good old DOS days) in the following way:

COM1: 3F8h COM2: 2F8h COM3: 3E8h COM4: 2E8h

The 'h'-character means hexadecimal number. When the radiometer shall be connected via a plug-in serial interface board, these addresses are not valid anymore. The operating system (like XP or Windows 2000) assigns different port addresses to the serial interfaces because they are treated as external hardware.

When the host software starts, it reads the file **COMS.ADR** from the home directory **MY_DIRECTORY** (see section 5.1.2). If this file is not present, the default COM port addresses listed above are used. Otherwise it takes the port addresses given in the **COMS.ADR** file (file format ASCII).

A typical content of this file might look like this:

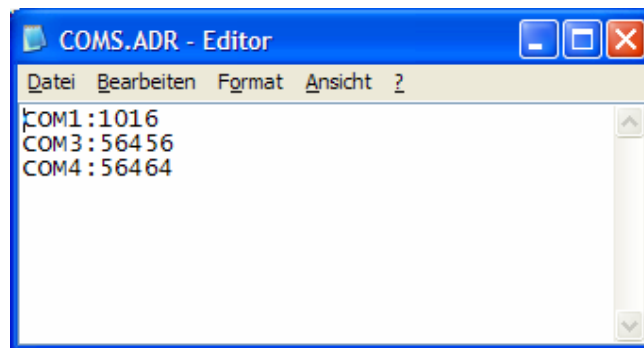

The numbers following the colon of each COM entry are the port addresses of the associated COM interfaces in **decimal format**.

The following procedure describes the way of how to get the port addresses from the operating system:

First select the Control Panel from the operating systems START page and follow the menu path to the Device Manager:

Control Panel->System->Hardware->Device Manager.

The following (similar) hardware list appears on the screen:

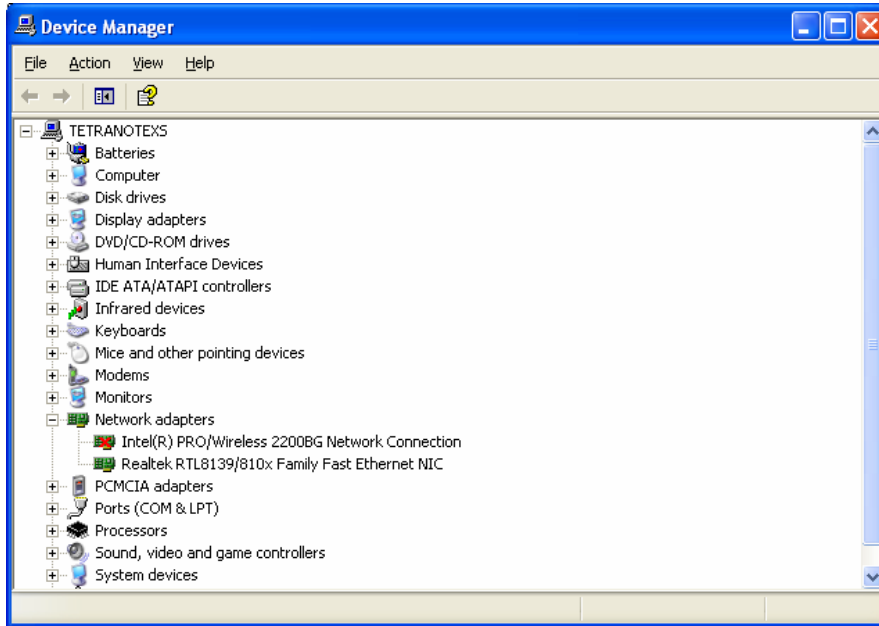

Click on the Ports (COM & LPT) entry. A list of installed COM and LTP interfaces is displayed:

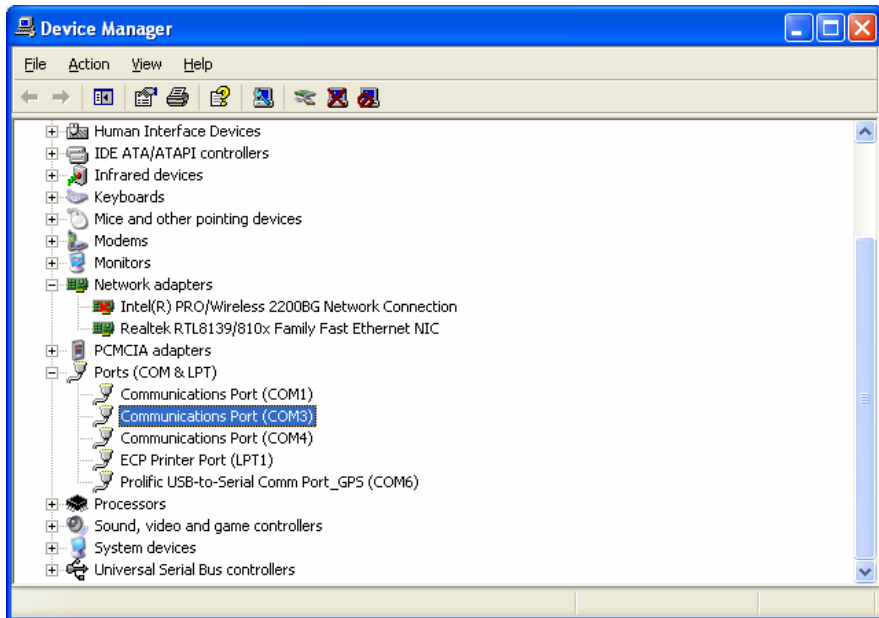

Double click on the COM port you want to use for the radiometer connection (COM3 in this example):

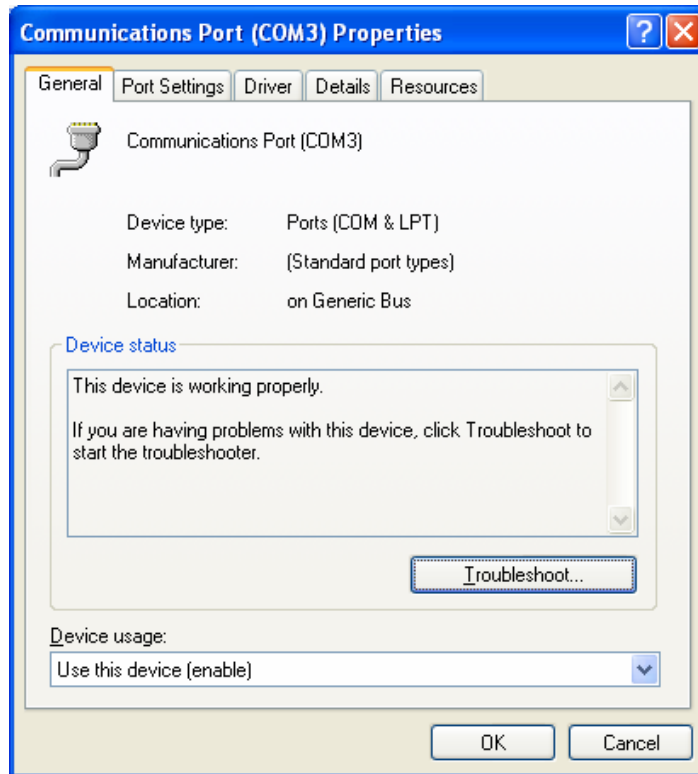

... and select the 'Resources' tag:

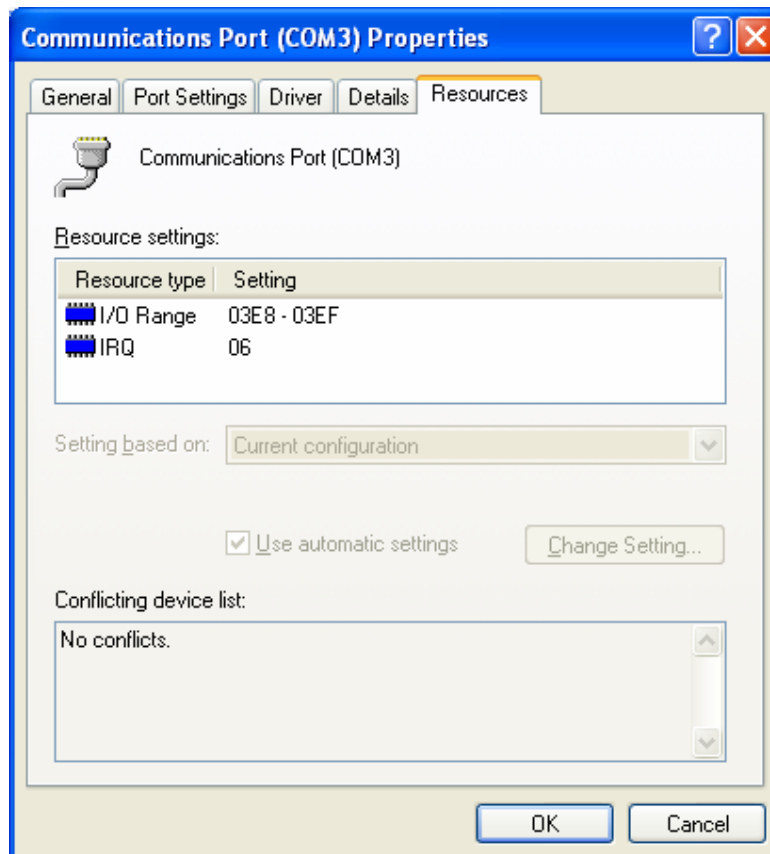

The port address we are looking for is the first value under 'Setting' in the 'I/O Range' resource type line (03E8 in this example). To enter this value into the *COMS.ADR* ASCII file, we have to convert this Hex number to Decimal. E.g. 3E8h → 1000d (use the systems Calculator to assist you in the conversion from Hex to Decimal). (3E8h is the default port address for COM3, so in this particular example you do not have to edit the *COMS.ADR* file). Then edit the decimal number for the port in the *COMS.ADR* file and save the file (overwrite the old one). Restart the R2CH.EXE host software to get access to the right COM interface port.

Appendix E (Physical Radiometer Dimensions)

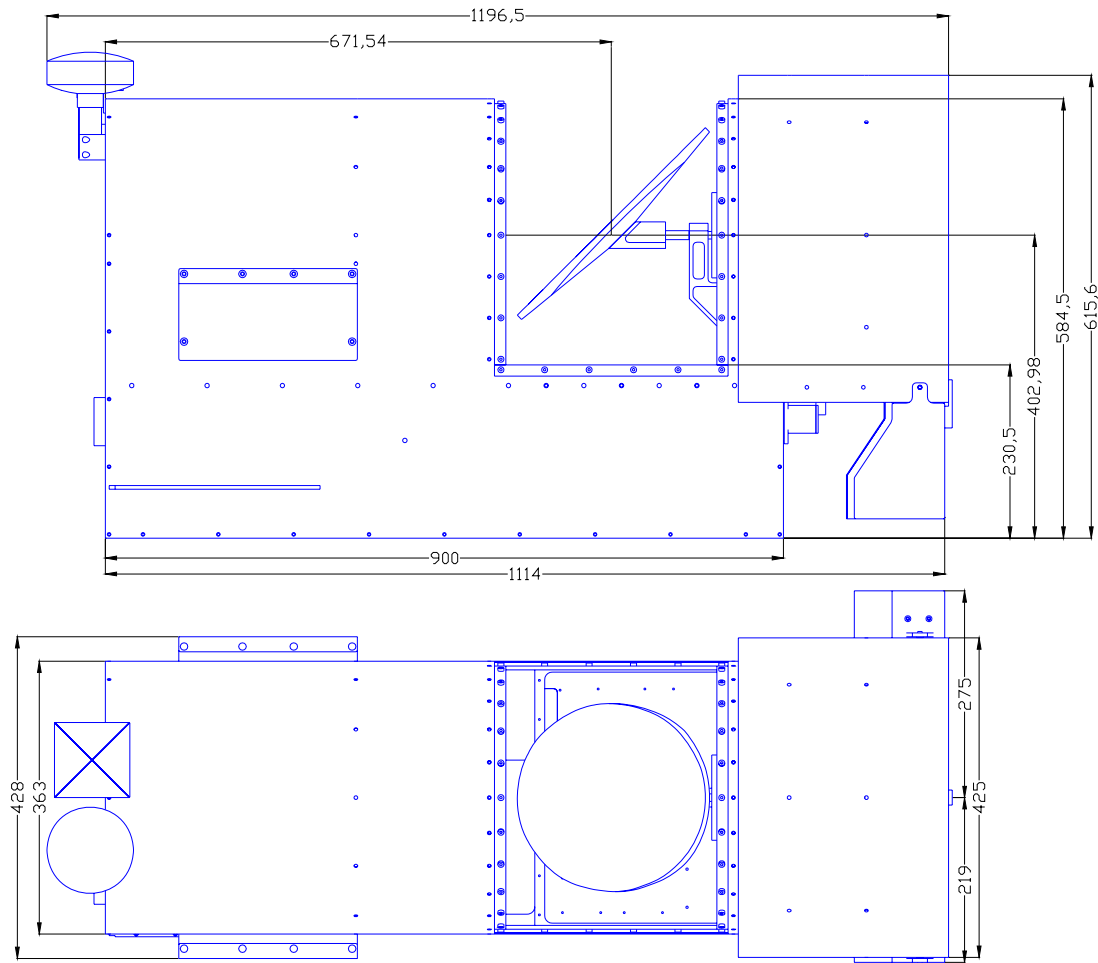

Appendix F (Interconnections)

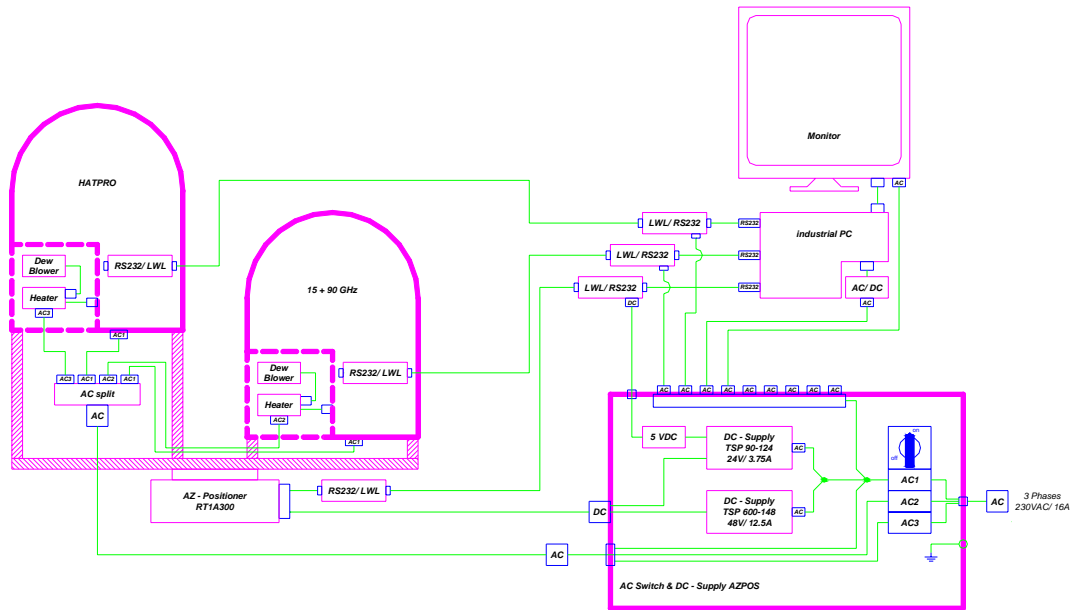

Appendix G (Inventory List)

The following components belong to the ATPROP system (packing list):

- RPG-HATPRO radiometer
- RPG-15-90 radiometer
- Heitronix IR radiometer KT-19 (9-11 μm)
- 2 rain sensors
- 2 GPS clocks
- 2 blower systems + 2 heater modules
- Instrument stand and turn table (azimuth positioner) with adjustable feet
- Azimuth controller supply unit with power switch
- Cold target frame + external target for HATPRO abs. calibrations
- 2 mounting screws for cold target
- 2 external calibration targets for RPG-15-90 abs. calibrations
- precision thermometer for RPG-15-90 hot target
- 2 Host computers with installed operating software (industrial type) + 2 monitors + 2 water proof keyboards
- Connector protectors for transportation purposes
- 1 power cable, 50 m
- 1 supply cable for azimuth driver
- 3 fiber optics cables for data transfer
- 1 screw driver tool set