

# Spectrum Analyzer (MP-3000) versus Filter Bank (RPG-HATPRO) Receiver Design for Profiling of Earth's Atmosphere

Thomas L. Rose  
Radiometer Development and System Engineering  
Radiometer Physics GmbH  
4 May 2009

## Introduction

Passive microwave radiometers are well suited to measure humidity and temperature profiles in the troposphere of the earth, as well as integrated quantities like the integrated water vapour (IWV) and liquid water content of clouds (LWP). The humidity information is taken from the shape of the single water vapour line at 22.24 GHz (line width approx. +/-6 GHz) while the temperature profile is derived from the shape of the oxygen line around 60 GHz (line width approx. +/- 8 GHz). Because the lines are symmetrical, only one half of the line has to be measured for profiling. The lines are strongly pressure broadened (see Fig.A).

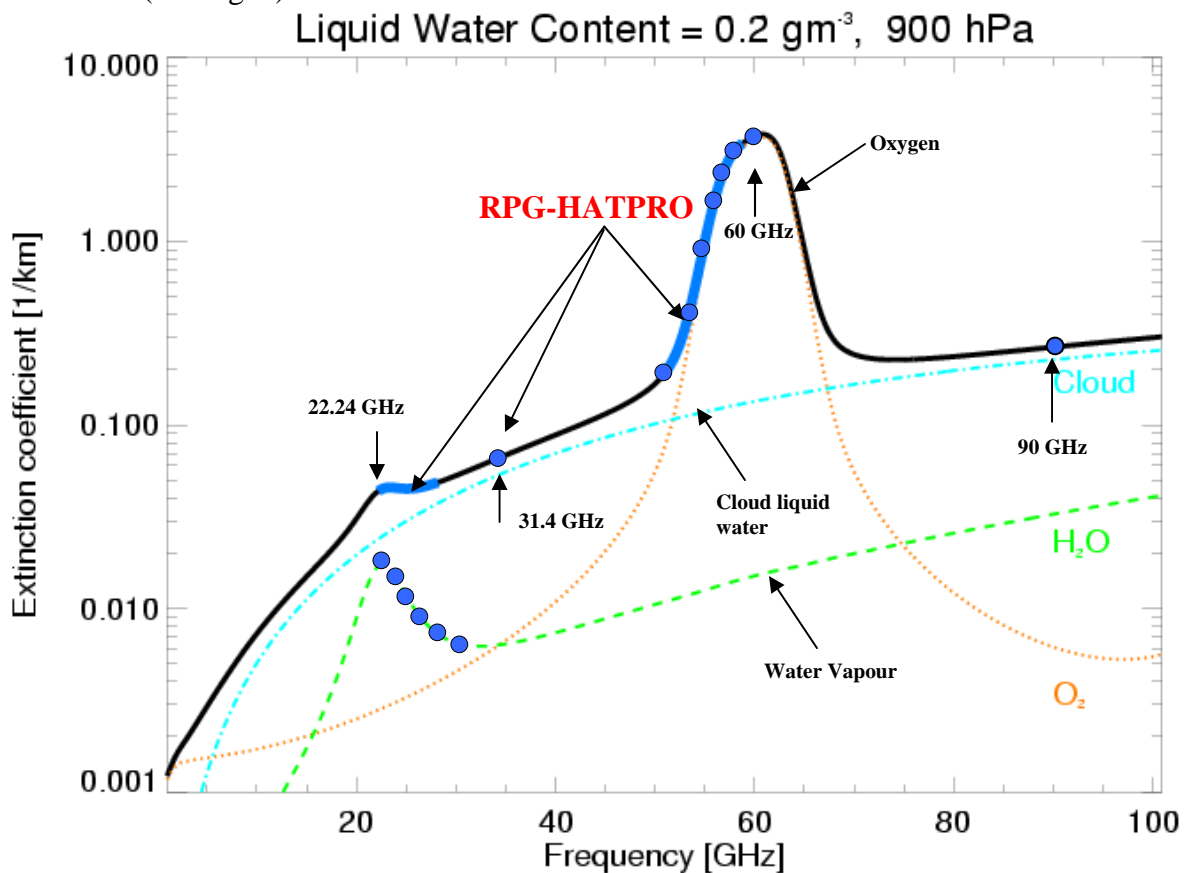

Fig.A

Because of the pressure broadened line shapes, the information content of the water vapour line and oxygen line are limited to 4 (water vapour) and 5 (oxygen line) independent degrees of freedom. This means that 4 numbers can completely characterize the shape of the water vapour line and 5 numbers can completely describe all the information in the oxygen line. This is similar to the fact that a point in space is uniquely defined by three numbers (three dimensions). Or in other words: A high spectral resolution is not required to measure a broad spectral line.

Consequently, in principle the measurement of four channels (at the right frequency points) is sufficient to capture the full information content in the water vapour line and 5 channels are sufficient for the oxygen line. A few more channels help to reduce noise (when measured simultaneously) and increase redundancy in the case of external interferences.

### Tunable single channel vs. multiple parallel channels

The aim of the radiometer is to measure the information content in the atmospheric lines as accurate as possible which means with the lowest possible measurement noise. In order to do this, the radiometer has to measure at multiple frequencies to capture the line shapes with a maximum integration time. Two concepts have been realized: The spectrum analyzer (MP-3000, Radiometrics) concept and the filter bank (RPG-HATPRO, RPG) receiver.

#### Spectrum Analyzer:

A spectrum analyzer uses basically a single amplifier, filter and detector chain. The receiver input can be tuned to different signal frequencies (by a synthesizer) but the detection of the signals is performed by only one detector (Fig.B).

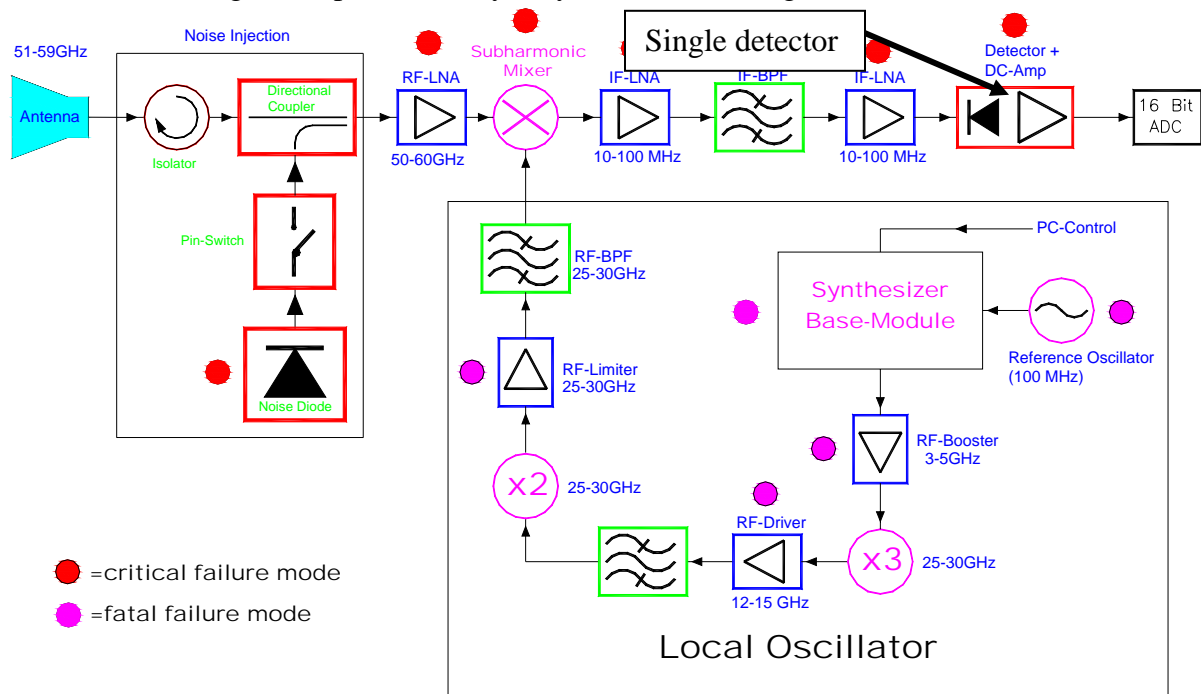
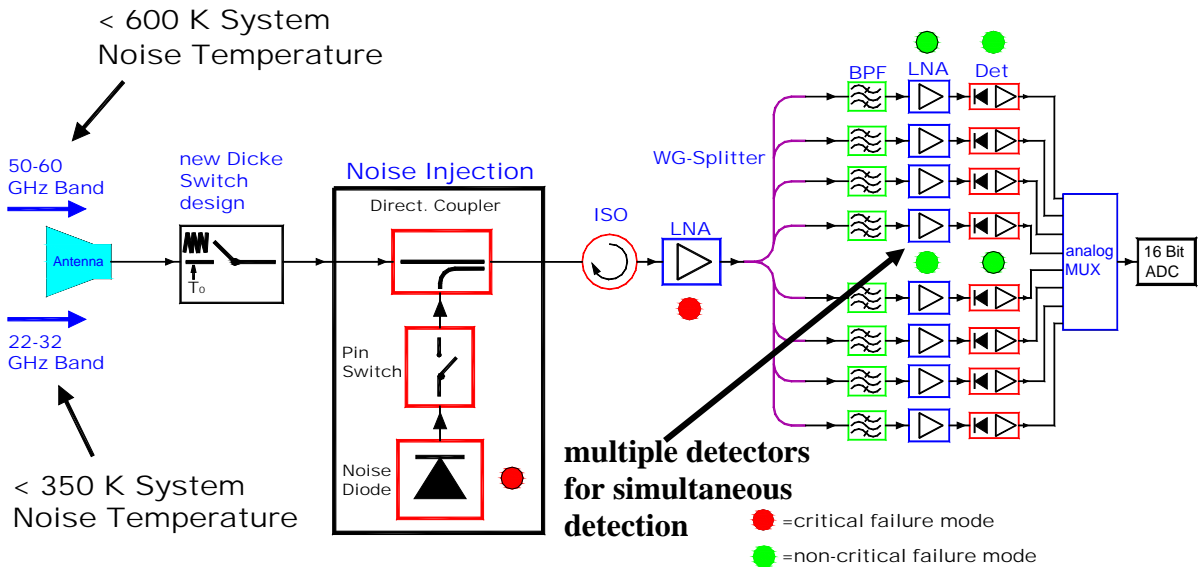

**Fig.B**

A spectrum analyzer is usually used when a high spectral resolution is required. The synthesizer can step in small steps (e.g. 10 MHz) so that it can scan the water vapour line and oxygen line with thousands of different frequency points. The important thing here is that the possible number of frequency points is high but the detection is only done by a single detector channel. During the scan, the synthesizer steps from one frequency point to the next (sequentially) and the measurement time at a single frequency point is small (duty cycle = 100% divided by the number of frequency points). A high number of frequency points are NOT required to measure the water vapour and oxygen line shapes, so the synthesizer's ability to measure at many frequency points is not an advantage.

**Filter Bank:**

A filter bank radiometer has multiple detection channels. This is a higher effort in the manufacturing of the receivers but it has the advantage that all the channels are detected simultaneously (in parallel) and each channel has its own filter. Each channel uses the full integration time (100% duty cycle, Fig.C). The number of parallel detection channels is determined by the task of the filter bank. In the case of a temperature and humidity profiler, the number of channels should be  $\geq 5$ . The RPG-HATPRO uses 7 channels for each profiler in order to have some redundancy in the case of an external interference signal on one of the channels.



**Fig.C**

## Why is a high channel duty cycle important?

One task of a profiler is to capture all information stored in the atmospheric line shapes. We have already explained that a relatively small number of channels are sufficient to do this (see also the frequency tables of satellite radiometers for earth atmospheric observations). The other task of the radiometer is to measure this information with a high **precision** which is equivalent to the requirement of low noise. In reality, all measurements of real instruments produce noise which limits the accuracy of the measurement. Most of the noise is usually not frequency dependent (white noise) and a common technique to reduce this noise is to maximize the integration time. The higher the integration time for a measurement, the lower the noise and the higher is the precision. The noise amplitude (a measure for the amount of noise) is reduced by the square root of the integration time. Thus, increasing the integration time by a factor of 4 reduces the noise by a factor of 2. If a radiometer channel has a duty cycle of 10%, its precision is about three times less (square root of 10) compared to a radiometer channel with 100% duty cycle.

## Why is a high precision important for a profiling radiometer?

**1. Boundary layer temp. inversions:** An important application of the profiling radiometer is the detection of low level temperature inversions. Such inversions play an important role for the thermal energy flux (they block the transport of heat and air from the ground to higher atmospheric levels) and the reduced transportation of aerosols and chemicals from the ground up into the atmosphere.

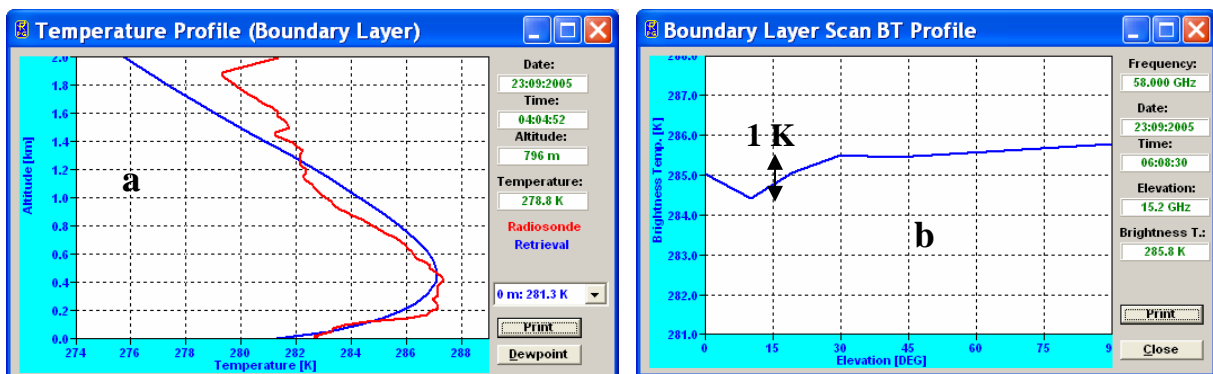

**Fig.D:** Low level temperature inversion (a) and associated brightness temperature elevation scan (b). The  $T_B$  variation in (b) is only 1 K @58 GHz for the full elevation scan ( $5^\circ$  to  $90^\circ$ ).

One can increase the number of independent information (the number of degrees of freedom) in a measurement of an oxygen line channel, by scanning the elevation angle. This is not an increase of information in frequency space (this would not resolve the vertical structure of an inversion in the atmospheric boundary layer (ABL), a vertical resolution of 50 m can be achieved with this method. By only observing in zenith direction, the vertical resolution is much worse (only 250 m in the ABL). Fig.D shows a typical temperature inversion and its associated brightness temperature measurement of

the radiometer. A radiometer directly measures the sky brightness temperatures at different frequencies and a mathematical algorithm (called a retrieval) is used to derive the temperature profile from the sky brightness temperatures. The major task of the radiometer is to measure the sky brightness temperatures with the highest possible precision. In Fig.D(b) the brightness temperature variation of an elevation scan is shown. All the information about the temperature inversion is stored in this scan. As can be seen from plot Fig.D(b), the variation is only one Kelvin. If the noise of the measurement would be higher than 0.1K, the detailed structure of the resulting temperature inversion would be hidden. Therefore a maximum integration time for each frequency layer point is required and 100% is the maximum one can achieve, but only with a simultaneous measurement of all frequencies. Fig.E shows the formation and decay of an inversion.

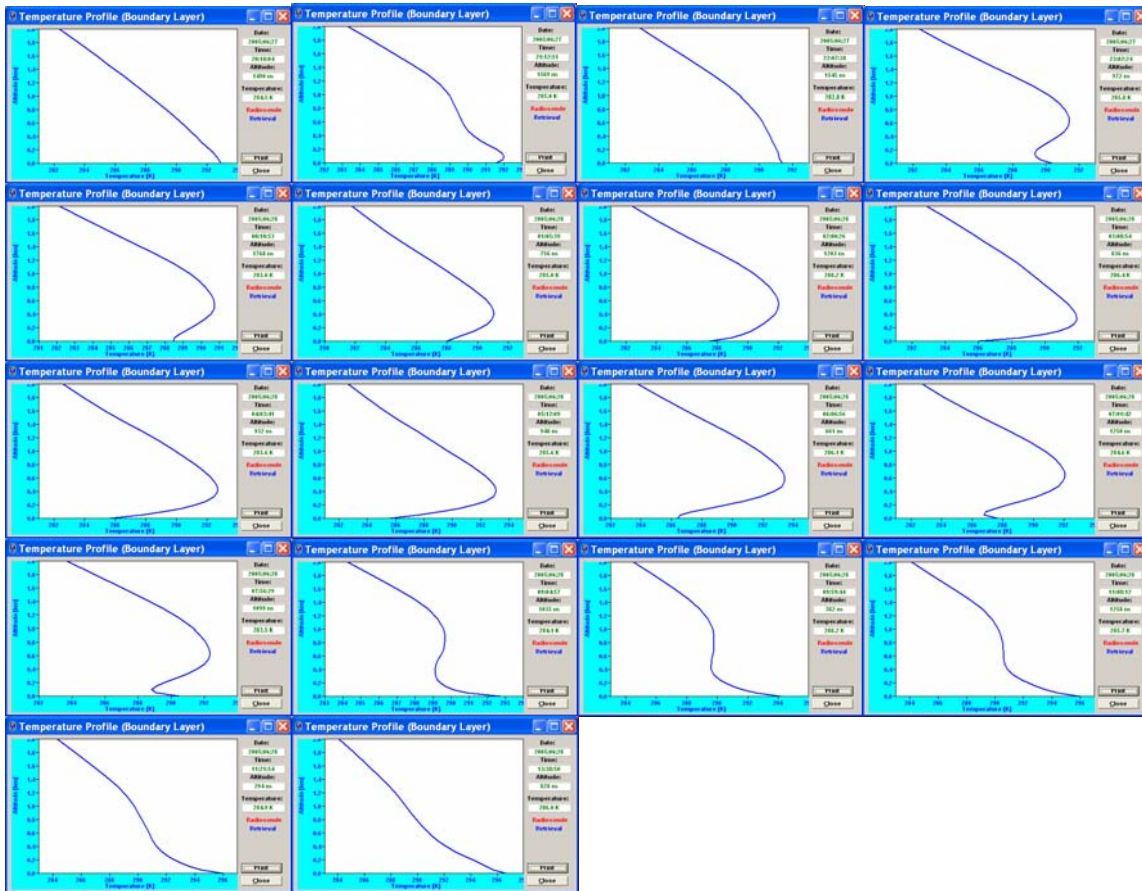

**Fig.E:**

One scan takes about 2 minutes with a filter bank radiometer (100% duty cycle for each channel) but would take more than 30 minutes with the MP-3000 synthesizer radiometer (duty cycle 8% for each frequency point), assuming the same precision. The temperature profile sampling period should be in the order of 10-15 minutes to monitor the inversion with sufficient time resolution.

**2: Fast 2D sky mapping:** Fig.F shows a full sky scan of an inhomogeneous humidity field with 320 measurement points, using all 14 filter bank channels for each point. The scan duration is only 7 minutes for a filter bank radiometer.



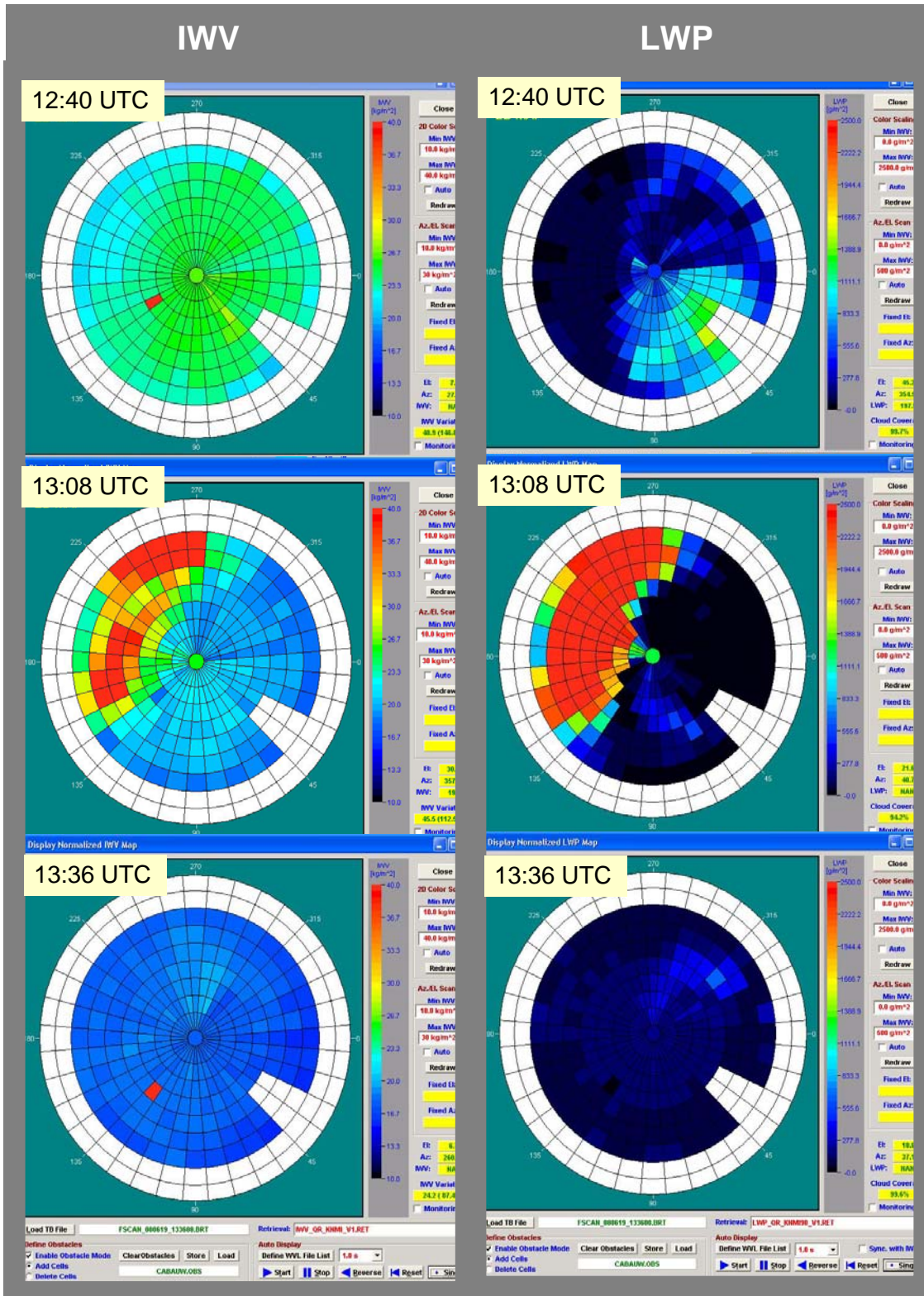
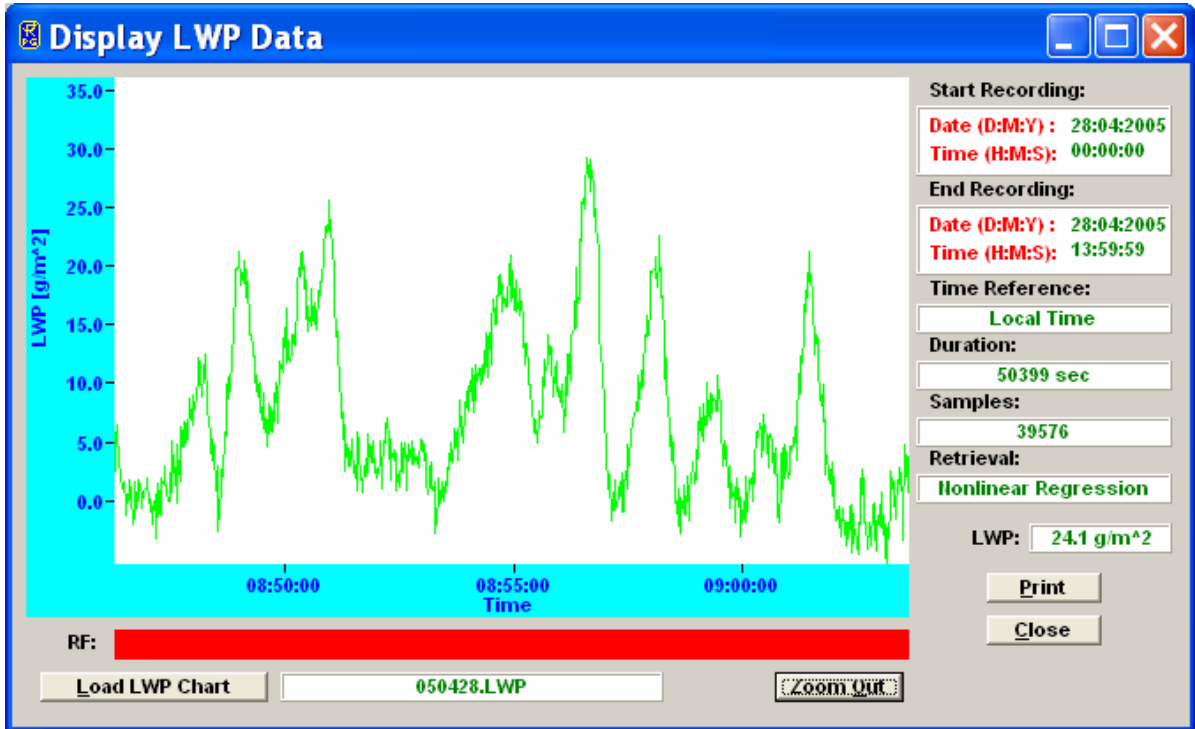

Fig.F:

**3: Fast LWP time series:** Fig.G shows the rapid changes of a cloud liquid water measurement. At high wind speeds the thickness of the cloud layer above the radiometer can change within seconds. The one second temporal resolution of the filter bank radiometer is capable of monitoring these fast changes. The effective temporal resolution of the MP-3000 spectrum analyzer is only 12 seconds.



*Fig.G:*

**Any other important radiometer features?**

1. **High spatial resolution:** The optical beam width of the radiometer should be as small as possible. During the ABL scans for temperature profiling, the radiometer scans down to  $5^\circ$  elevation. If the radiometer beam width is too high (e.g.  $\pm 4^\circ$ ), the beam is affected by the ground emission and the measurement is spoiled. Also a wide beam tends to average the contributions from different layers in the ABL and therefore reduces the vertical resolution. Unfortunately, a narrow beam requires a bigger antenna. This is why the RPG-HATPRO antenna size (250 mm) is almost twice as big as the MP-3000 antenna size (140 mm) and the instrument is heavier because of that. Since the RPG-HATPRO is still a portable radiometer, this disadvantage is accepted by most users.
2. **Low sensitivity to external interferences:** The RPG-HATPRO is a direct detection radiometer. It does not have any mixers or active sources (local oscillators) which down-convert the reception frequency band (e.g. 22-32 GHz) to a low frequency band (e.g. 100 MHz, as for the MP-3000). Therefore the RPG-HATPRO is totally immune to interferences in these low frequency bands (also called IF band = Intermediate Frequency band). Unfortunately, many external

sources around 100 MHz exist, like strong radio transmitters (FM radio is operated between 82 MHz and 104 MHz), mobile phone stations, etc. Direct detection receivers with their advantages require a signal filtering and detection at the high reception frequencies. State of the art technology developed over the last 7-10 years has made this receiver technology feasible.